

Pioneers in new technology!

PROFESSIONAL

Lighting

COLLECTION

ΚΑΤΑΛΟΓΟΣ ΦΩΤΙΣΜΟΥ

EUROLAMP®

2024

Company Profile

EUROLAMP®

EUROLAMP GREECE SA
3rd km Symmachiki Road, Oraiokastro,
57013, Thessaloniki, Greece
Tel: +30 2310 574802
Fax: +30 2310 574919
Email: info@eurolamp.gr
www.eurolamp.gr

EUROLAMP BELGIUM SRL
Avenue Thomas Edison 115
1402 - Nivelles
Belgique
Siège Social +32 (0) 493 444 162 (FR/EN)
Délégué Wallonie +32 (0) 492 245 612 (FR)
Email: info@eurolamp.be

EUROLAMP CHINA SA
Rm1101-1106. JiuYou Mansion
No.1158 Huyi Highway
Nanxiang Town, Jiading District
201800 Shanghai / P.R. China
Tel.+86-21-64379558
Fax: +86-21-64722682

Η EUROLAMP A.B.E.E. είναι μία διαρκώς αναπτυσσόμενη ελληνική εταιρία που πρωτοπορεί και καινοτομεί, κάνοντας τη διαφορά εδώ και 25 χρόνια!

Διαθέτουμε τεράστια προϊόντα φωτισμού (οικιακής και επαγγελματικής χρήσης), λαμπτήρες, ηλεκτρολογικού υλικού, Χριστουγεννιάτικου φωτισμού και διάκοσμου, κλιματιστικές μονάδες, ηλεκτρικές συσκευές, μπαταρίες, φωτοβολταϊκά συστήματα και προϊόντα ηλεκτροκίνησης (ποδήλατα, scooter, σταθμοί φόρτισης οχημάτων).

Εξεισώμαστε διαρκώς με νέα προϊόντα σύγχρονης τεχνολογίας που ανταποκρίνονται στις απαιτήσεις του σύγχρονου εμπορίου, φιλικά προς το περιβάλλον και εναρμονισμένα με όλους του κανόνες που επιτάσσει η Ευρωπαϊκή και Διεθνής Νομοθεσία.

Διατηρούμε αξιόπιστες και μακροχρόνιες συνεργασίες και διαθέτουμε ένα ισχυρό δίκτυο πωλήσεων με περισσότερα από 2.500 σημεία πώλησης στην Ελλάδα, την Κύπρο και σε περισσότερες από 30 χώρες εντός και εκτός Ε.Ε.

Με το βλέμμα στραμμένο στο μέλλον και τη φροντίδα του εξειδικευμένου προσωπικού μας, ενδυναμώνουμε τη συνεχή στήριξη των συνεργατών μας με κοινό παρονομαστή την ικανοποίηση του τελικού καταναλωτή!

Οι αξίες μας

- Σεβασμός, συνέπεια και αξιοπιστία
- Προσωπικό και επιχειρηματικό ήθος
- Δημιουργία αδιάρρηκτων σχέσεων με τους συνεργάτες
- Καινοτομία και συνεχής εξέλιξη
- Υψηλή ποιότητα προϊόντων και υπηρεσιών
- Συνεχής επένδυση σε ανθρώπινο δυναμικό

EUROLAMP SA is a constantly growing Greek company that pioneers and innovates, making a difference for 25 years!

We have a huge range of lighting products (home & business), lamps, electrical equipment, Christmas lighting and decorations, air conditioners, electrical appliances, batteries, photovoltaic systems and e-mobility products (bikes, scooters, vehicle charging stations).

We are constantly evolving with new products of modern technology that meet the requirements of modern trade, are environmentally friendly and in harmony with all the rules required by European and International Legislation.

We maintain reliable and long-term partnerships and have a solid sales network with more than 2,500 sales points in Greece, Cyprus and more than 30 countries inside and outside the EU.

With an eye on the future and the care of our specialized staff, we strengthen the continuous support of our partners with the common goal being the satisfaction of the end consumer!

Our values

- Respect with consistency and reliability
- Personal and business ethics
- Creating unbreakable relationships with our partners
- Innovation and continuous development
- High quality products and services
- Continuous investment in human resources

Get in touch!

Ελάτε σε επαφή

Η Eurolamp έχει παρουσία σε μια ποικιλία μέσων κοινωνικής δικτύωσης στα οποία μπορείτε να παρακολουθείτε την εξέλιξη της εταιρεία αλλά κυρίως τα καινοτόμα προϊόντα και λύσεις που διαθέτουμε!

Eurolamp has a presence on a variety of social media that you can follow the development of the company but mainly the innovative products and solutions we can provide you!

facebook  **YouTube**  **LinkedIn**  **Instagram**

Σκανάρετε το QR code και βρείτε μας στο κοινωνικό μέσο της επιλογής σας



Scan the QR code and find us on the social media of your choice



Banking Accounts

Τραπεζικοί λογαριασμοί

Στοιχεία τραπεζικών λογαριασμών **EUROLAMP ABEE**
EUROLAMP SA banking accounts

ΕΘΝΙΚΗ ΤΡΑΠΕΖΑ / NBG: 224/470122-40
IBAN: GR79 0110 2240 0000 2244 7012 240

ΕΘΝΙΚΗ ΤΡΑΠΕΖΑ / NBG: 840/470602-19
IBAN: GR4801108400000084047060219

ΤΡΑΠΕΖΑ ΠΕΙΡΑΙΩΣ / PIRAEUS BANK: 5229-063351-500
IBAN: GR26 0172 2290 0052 2906 3351 500

ALPHA BANK: 703 00 2002 016002
IBAN: GR86 0140 7030 7030 0200 2016 002

EUROBANK: 0026.0216.91.0200622333
IBAN: GR72 0260 2160 0009 1020 0622 333

Στοιχεία τραπεζικών λογαριασμών Βελγίου **EUROLAMP BELGIUM SPRL**
EUROLAMP BELGIUM SPRL banking accounts

BENEFICIARY NAME: EUROLAMP BELGIUM SPRL
BENEFICIARY ADDRESS: 829, Chaussee De Marche BTE2 B-5100
WIERDE BELGIUM
BANK: AXA BANK BELGIUM
IBAN ACCOUNT: BE87751207895894
BIC: AXABBE22

Certifications

Πιστοποιήσεις



ISO 9001:2015
ISO 14001:2015
ISO 27001:2013
ISO 45001:2018
ISO 14001:2015
CERTIFIED



ΥΠΟΥΡΓΙΚΗ ΑΠΟΦΑΣΗ
ΔΥ8Δ/Γ.Π. ΟΙΚ/1348/2004
ISO 13485:2016
CERTIFIED



LIBERO ASSURANCE

ISO 37001
ISO 39001



ISO 5001:2018



Παροχή προϊόντων και υπηρεσιών, σύμφωνα με τις κορυφαίες προδιαγραφές και απαιτήσεις ποιότητας

Εφαρμόζοντας τα διεθνή πρότυπα για ένα ενιαίο σύστημα διαχείρισης ποιότητας & περιβαλλοντικής διαχείρισης, η EUROLAMP είναι πιστοποιημένη με ISO 9001:2015 και ISO 14001:2015 και συμμετέχει σε αρκετά ολοκληρωμένα συστήματα ανακύκλωσης.

Η εταιρία έχοντας εισαχθεί στον κλάδο των βιοκτόνων και κλινικών προϊόντων, λειτουργεί σύμφωνα με το πρότυπο ISO 13485 και την Υ/Α 1348 ώστε να διασφαλίζεται η ασφαλής και ακίνδυνη για την υγεία, διανομή των προϊόντων. Πιστοποιημένα προϊόντα για ασφαλή χρήση με βάση την Ευρωπαϊκή και Διεθνή νομοθεσία και εφόσον απαιτείται, διαθέτουν έγκριση από τον ΕΟΦ, έγκριση από τον ευρωπαϊκό οργανισμό χημικών προϊόντων ECHA και κατοχύρωση στην ευρωπαϊκή βάση δεδομένων, συμμορφούμενα με την κοινοτική και εθνική νομοθεσία.

Η εταιρία μέχρι το τέλος του 2022 θα πιστοποιηθεί σε άλλα πέντε συστήματα, της διαχείρισης της οδικής ασφάλειας, της προστασίας δωροδοκίας, της επιχειρησιακής συνέχειας, των παροχών σε κτίρια και της κοινωνικής ευθύνης.

Επίσης, εγκατέστησε ένα σύστημα διαχείρισης ασφάλειας πληροφοριών, που είναι σύμφωνο με το πρότυπο ISO 27001:2013

Με όραμα την αειφόρο ανάπτυξη, δεσμεύεται για την προσπάθεια μείωσης της ενεργειακής κατανάλωσης και των εκπεμπόμενων ρύπων που αφορούν στις δραστηριότητες παραγωγής και εμπορίας ηλεκτρολογικού υλικού στις κεντρικές εγκαταστάσεις της στα Διαβατά Θεσσαλονίκης, μέσω του συστήματος ενεργειακής διαχείρισης σύμφωνα με το πρότυπο ISO 50001:2018.

Products supply and services, according to the highest quality and specifications requirements

In compliance with all the international standards for a unified full quality and environmental management system, EUROLAMP SA is certified with a ISO 9001:2015 and a ISO 14001:2015 and participates in several integrated recycling systems.

The company, having entered the biocidal and clinical products, it operates according to ISO 13485 standards and Ministerial Decision 1348, so as to secure the safe and harmless for health, products distribution. It markets certified products for safe use, according to European and international law, which have the National Organization for Medicines approval, wherever imposed, European Chemicals Agency approval as well as the patent in the European database, and are compliant to the European and national legislation.

By the end of 2022, the company will be certified in five additional systems: road safety management, bribery safety management, business continuity, buildings supply and social responsibility.

What's more, the company has installed an information safety system, which is in accordance to the ISO 27001:2013 standard.

With a vision to sustainable development, EUROLAMP SA is committed to an effort to limit power consumption and emitted pollutants from production activities and electrological supply trade at our central facilities at Diavata, Thessaloniki, through the power management system, according to ISO 50001:2018 standard.

Νέα δυνατότητα παραγγελίας μέσω του app

EUROLAMP B2B

New ordering feature through the app



- Διαθεσιμότητα των προϊόντων
- Ημερομηνία παραλαβής των προϊόντων στις αποθήκες μας
- Καταχώρηση παραγγελίας
- Παρακολούθηση της εξέλιξης της παραγγελίας
- Πρόσβαση σε οικονομικά στοιχεία

Στον κατάλογο μας, σε κάθε κωδικό θα βρείτε και το barcode του. Με την εφαρμογή EUROLAMP B2B μπορείτε να σκανάρετε το barcode που επιθυμείτε και να κάνετε την παραγγελία σας εύκολα και γρήγορα! Ζητήστε μας να σας αποστείλουμε τους κωδικούς πρόσβασης!

Σχεδιασμένη και δομημένη σε πλήρη αρμονία με τη διαδικτυακή πλατφόρμα B2B, έρχεται να συμπληρώσει στο έπακρο όλες τις δυνατότητες που θα θέλατε να έχετε από ένα Ψηφιακό Πολυ-εργαλείο! Εντοπίστε τα προϊόντα που σας ενδιαφέρουν, αναζητήστε νέα προϊόντα, προσφορές και προωθητικές ενέργειες, επαληθεύστε τη διαθεσιμότητα των κωδικών και την ημερομηνία παραλαβής των προϊόντων στις αποθήκες μας, προσθέστε κωδικούς στη παραγγελία σας απλά σκανάροντας το προϊόν και κρατείστε τον έλεγχο των παραγγελιών σας! Όλα αυτά μέσω του κινητού σας!

Τώρα μπορείτε να έχετε στο κινητό σας όλες τις πληροφορίες που χρειάζεστε άμεσα και εύκολα με ένα scroll! Κατεβάστε τη νέα mobile εφαρμογή EUROLAMP B2B από το App Store (iOS) ή το Play Store (ANDROID).

** Για οποιαδήποτε επιπρόσθετη πληροφορία σχετικά με την εφαρμογή EUROLAMP B2B App παρακαλούμε απευθυνθείτε στον πωλητή που σας εξυπηρετεί.*

- Availability of products
- Delivery date of the products in our warehouses
- Order entry
- Monitoring progress of the order
- Access to financial data

In our catalog, in each code you will find its barcode. With the EUROLAMP B2B application you can scan the barcode you want and place your order easily and quickly! Ask us to send you the passwords!

Designed and built in complete harmony with the B2B web platform, it comes to fill to the fullest all the possibilities you would like to have from a Digital Multi-tool! availability of codes and the date of receipt of products in our warehouses, add codes to your order simply by scanning the product and keep control of your orders! All this through your mobile!

Now you can have all the information you need on your mobile phone instantly and easily with one scroll! Download the new EUROLAMP B2B mobile application from the App Store (iOS) or the Play Store (ANDROID).



EUROLAMP[®]
Smart WiFi



Στη γκάμα των έξυπνων συσκευών για το σπίτι από τη EUROLAMP Smart, περιλαμβάνονται λαμπτήρες Wi-Fi, προβολείς Wi-Fi, αντάπτορες ρεύματος Wi-Fi, πολύπριζα Wi-Fi, «έξυπνα» τηλεχειριστήρια υπέρυθρων (IR remote controller) με την προοπτική για πολλές περισσότερες λύσεις στο άμεσο μέλλον.



Η εφαρμογή EUROLAMP Smart app είναι εύκολη στη χρήση και είναι πλήρως συμβατή με όλες τις συσκευές EUROLAMP Smart WiFi αλλά και όλες τις συσκευές που φέρουν την ένδειξη «Powered by TUYA». Άρα με μια εφαρμογή μπορεί ο χρήστης να ελέγξει όλες τις «έξυπνες» συσκευές χωρίς περιορισμούς.

The range of smart home appliances from EUROLAMP Smart includes Wi-Fi Lamps, Wi-Fi Flood Lights, Wi-Fi power adapters, Wi-Fi sockets, “smart” infrared remote controls with the prospect of many more solutions in the near future.

The EUROLAMP Smart app is easy to use and is fully compatible with all EUROLAMP Smart WiFi devices as well as all devices labeled “Powered by TUYA”. So with only one application the user can manage all the “smart” devices without restrictions.



Quality Classifications

Σήμανση ποιότητας



PRO SERIES

Κορυφαία ποιότητα και τελευταία τεχνολογία σε επιλεγμένα προϊόντα για οικιακή και επαγγελματική χρήση. Υψηλά standards ασφάλειας, μεγάλη διάρκεια ζωής και εγγύηση έως 5 έτη.

Premium quality and use of the most recent technological advancements, in a selected group of products that are suitable for domestic and commercial use. Higher safety standards, long lasting lifetime and up to 5 years of warranty.



PLUS SERIES

Σειρά πολύ καλής ποιότητας, σε μεγάλη γκάμα κωδικών για οικιακές, επαγγελματικές και βιομηχανικές χρήσεις.

A Higher Quality series with a wide range of products suitable for domestic, professional and industrial use.























VALUE SERIES

Η κατηγορία περιλαμβάνει προϊόντα οικιακής και εμπορικής χρήσης, υψηλής απόδοσης και χαμηλού κόστους.

This category consists of high efficiency and low in cost products, that are suitable for general domestic and commercial applications.

Icons Explanation

Επεξήγηση εικονιδίων

W 48W	Power Ισχύς	V 220-240V	Voltage Τάση	Lm/W 90	Lumen/Watt
(CRI) RA >80	Colour rendering index Δείκτης απόδοσης χρώματος	PF >0,90	Power factor Συντελεστής ισχύος	 Life time 50.000h	Life time Διάρκεια ζωής
ON OFF 15.000	Switches On/Off Ενεργοποίηση-Απενεργοποίηση	 Weight 1,8kg	Weight Βάρος	 Operating Temperature -20 +40 °C	Operating Temperature Θερμοκρασία λειτουργίας
 NON DIMMABLE	Non Dimmable Device / Συσκευή χωρίς δυνατότητα ρύθμισης φωτεινότητας	 IP40	Ingress Protection rating Βαθμός Στεγανότητας	 YEARS WARRANTY	Years of Guarantee Χρόνια Εγγύησης
 DIMMABLE	Dimmable Device / Συσκευή με δυνατότητα ρύθμισης φωτεινότητας	 IK07	Resistance level Βαθμός αντίστασης	 GROUNDING	Grounding Γείωση
 DALI DIMMING	Dimming Type/ Τύπος ρύθμισης φωτεινότητας	 CLASS II	Appliance Class Τύπος Μόνωσης Καλωδίων	 MOTION SENSOR	Sensor Type Τύπος Αισθητήρα
 Flicker FREE	Flicker Free Δεν τρεμοπαίζει	 T8 TYPE	Lamp type Τύπος λάμπας	 G13 BASE	Lamp base type Τύπος βάσης λάμπας
 MAX7W	Maximum Watt for Led Lamp Μέγιστο Watt για Λάμπα Led	 SWITCH ON/OFF	Button switch on/off Κουμπι ενεργοποίησης	 AUTO ON/OFF	Auto switch on/off Αυτόματη ενεργοποίησης
COLOR WHITE	Product color Χρώμα προϊόντος	 120°	Detection Angle Γωνία ανίχνευσης	 TEST BUTTON	Test button Δοκιμαστικό κουμπι

Contents

Περιεχόμενα



09

Φωτιστικά Πάνελ LED
LED Lighting Panels



29

Φωτιστικά Χωνευτά LED SMD & COB
LED SMD & COB Recessed Fixtures



49

Φωτιστικά LED Εξωτερικά
LED Fixtures Surface Mounted



55

Φωτιστικά LED Κρεμαστά για Επαγγελματικούς Χώρους
Hanging LED Fixtures for Professional Use



57

Φωτιστικά LED Εφεδρικού Φωτισμού
Emergency LED Lighting



67

Σποτ Χωνευτά Αλουμινίου Σταθερά / Κινητά / Στεγανά
Spot Recessed Aluminum Fixed / Movable / Waterproof



77

Γύψινα Φωτιστικά LED Εσωτερικού χώρου
Plaster Lights LED Indoor use



87

Σποτ Χωνευτά LED Αρχιτεκτονικά & Γραμμικά
Spot Recessed LED Architectural & Linear



89

Φωτιστικά Γραμμικά LED χωνευτά & εξωτερικά
Linear Light Fixture LED recessed & surface



99

Σποτ LED Ράγας & Μαγνητικής Ράγας
Track Spot LED Lights & Magnetic Track



121

Σποτ LED Ράγας 2 γραμμών
Track Spot LED Lights 2 lines



129

Σποτ LED Ράγας 4 γραμμών
Track Spot LED Lights 4 lines



143

Φωτιστικά Πάγκου & εσωτερικού χώρου
Lighting LED fixtures indoor use



149

Φωτιστικά γραμμικά LED επαγγελματικής χρήσης
LED Linear Lighting for professional use



167

Προβολείς LED εξωτερικού χώρου οικιακής χρήσης
Flood Lights LED for domestic outdoor use



187

Προβολείς LED εξωτερικού χώρου επαγγελματικής χρήσης
Flood Lights LED for outdoor professional use



197

Φωτιστικά Δρόμου LED
Street Lights LED



209

Καμπάνες LED για επαγγελματική χρήση
High Bay LED for professional use



215

Φωτιστικά πισίνας και υποβρύχιο σποτ
Swimming pool lights & Underwater spot light

Φωτιστικά Πάνελ LED

LED Lighting Panels

Discover our new LED lighting panels

Νέα LED φωτιστικά πάνελ Ανακαλύψτε τα!

Γνωρίστε την ολοκαίνουρια γκάμα led πανέλ που δίνουν εξαιρετικές λύσεις απόδοσης και οικονομίας ακόμη και στους πιο απαιτητικούς χώρους. Διαχείριση και ευελιξία σε θερμοκρασίες χρώματος και ισχύος λειτουργίας όπως ποτέ άλλοτε!

Meet the brand new range of led panels that provide excellent performance and economy solutions even in the most demanding spaces. Management and flexibility in color temperatures and operating power like never before!

- ▶ Πάνελ με εξαιρετική ποιότητα φωτός UGR<19, εξοπλισμένα με τροφοδοτικό Tridonic για προσαρμοσμένη κατανάλωση με επιλογή μέσα από 4 επιλογές ισχύος λειτουργίας (watt)

Panels with excellent light quality UGR<19, equipped with Tridonic power supply for customized consumption with a choice of 4 operating power options (wattage)

- ▶ Πάνελ εξοπλισμένα με τροφοδοτικό Tridonic με υποστήριξη DALI για τη διαχείριση φωτός

Panels equipped with a Tridonic power supply with DALI support for light management

*DALI: Digital Addressable Lighting Interface / Διεύθυνση ψηφιακής διεπαφής φωτισμού

- ▶ Ασύγκριτη απόδοση φωτεινότητας σε αναλογία με την κατανάλωση με επίδοση 180Lm/W

Incomparable brightness output in proportion to consumption with performance 180Lm/W

ΧΩΝΕΥΤΑ BACKLIGHT TRIDONIC UGR16 RECESSED BACKLIGHT TRIDONIC UGR16



powered by
TRIDONIC
27W 34W 40W 48W



60x60cm

Volt: **220-240V 50/60Hz** • LED Type: **SMD2835**

Γωνία Δέσμης Φωτός / Beam Angle: **120°**

Ενεργειακή Κλάση / Energy Class: **F**

Start Time: **0,5sec** • PF > **0,90** • CRI > **80**

Θερμοκρασία Λειτουργίας / Operating Temperature: **-20/+40°C**

Υλικό / Material: **Αλουμίνιο & Πλαστικό / Aluminium & Plastic**

Σύνδεση / Connection: **Καλώδιο / Wire**

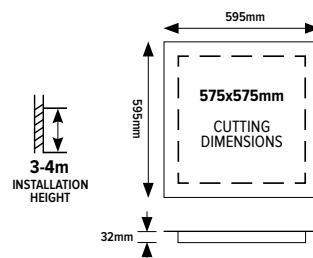

CODE	BARCODE	WATT	KELVIN	LUMEN/WATT	COLOR	PACKING	MOQ	PRICE (€)
145-56200	5207227202162	27-34-40-48	6500	105	WHITE	1/10	1	44,85
145-56201	5207227202179	27-34-40-48	4000	105	WHITE	1/10	1	44,85
145-56202	5207227202186	27-34-40-48	3000	105	WHITE	1/10	1	44,85



powered by
TRIDONIC
27W 34W 40W 45W



120x30cm

Volt: **220-240V 50/60Hz** • LED Type: **SMD2835**

Γωνία Δέσμης Φωτός / Beam Angle: **120°**

Ενεργειακή Κλάση / Energy Class: **F**

Start Time: **0,5sec** • PF > **0,90** • CRI > **80**

Θερμοκρασία Λειτουργίας / Operating Temperature: **-20/+40°C**

Υλικό / Material: **Αλουμίνιο & Πλαστικό / Aluminium & Plastic**

Σύνδεση / Connection: **Καλώδιο / Wire**

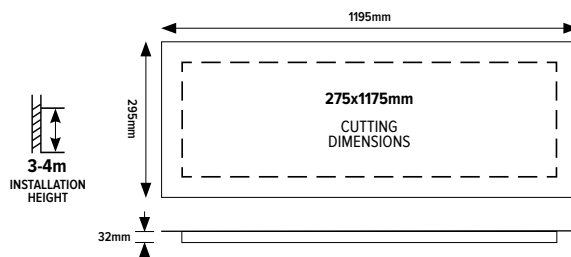

CODE	BARCODE	WATT	KELVIN	LUMEN/WATT	COLOR	PACKING	MOQ	PRICE (€)
145-56203	5207227202193	27-34-40-45	6500	105	WHITE	1/5	1	56,65
145-56204	5207227202209	27-34-40-45	4000	105	WHITE	1/5	1	56,65
145-56205	5207227202216	27-34-40-45	3000	105	WHITE	1/5	1	56,65

ΕΞΩΤΕΡΙΚΑ BACKLIGHT TRIDONIC UGR16 SURFACE BACKLIGHT TRIDONIC UGR16



powered by
TRIDONIC
27W 34W 40W 48W



60x60cm

Volt: **220-240V 50/60Hz** • LED Type: **SMD2835**
Γωνία Δέσμης Φωτός / Beam Angle: **120°**
Ενεργειακή Κλάση / Energy Class: **F**
Start Time: **0,5sec** • PF > **0,90** • CRI > **80**
Θερμοκρασία Λειτουργίας / Operating Temperature: **-20/+40°C**
Υλικό / Material: **Αλουμίνιο & Πλαστικό / Aluminium & Plastic**
Σύνδεση / Connection: **Καλώδιο / Wire**

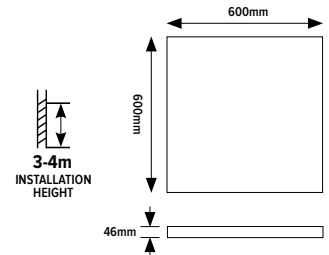

CODE	BARCODE	WATT	KELVIN	LUMEN/WATT	COLOR	PACKING	MOQ	PRICE (€)
145-56209	5207227202223	27-34-40-48	6500	105	WHITE	1/7	1	58,95
145-56210	5207227202230	27-34-40-48	4000	105	WHITE	1/7	1	58,95
145-56211	5207227202247	27-34-40-48	3000	105	WHITE	1/7	1	58,95



powered by
TRIDONIC
27W 34W 40W 45W



120x30cm

Volt: **220-240V 50/60Hz** • LED Type: **SMD2835**
Γωνία Δέσμης Φωτός / Beam Angle: **120°**
Ενεργειακή Κλάση / Energy Class: **F**
Start Time: **0,5sec** • PF > **0,90** • CRI > **80**
Θερμοκρασία Λειτουργίας / Operating Temperature: **-20/+40°C**
Υλικό / Material: **Αλουμίνιο & Πλαστικό / Aluminium & Plastic**
Σύνδεση / Connection: **Καλώδιο / Wire**

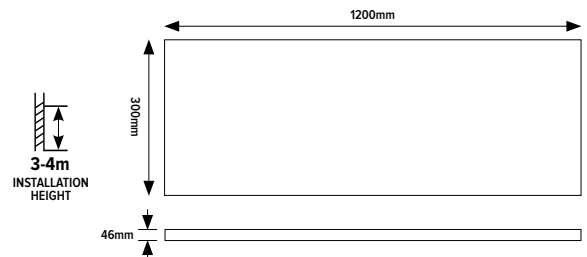

CODE	BARCODE	WATT	KELVIN	LUMEN/WATT	COLOR	PACKING	MOQ	PRICE (€)
145-56212	5207227202254	27-34-40-45	6500	105	WHITE	1/5	1	72,80
145-56213	5207227202261	27-34-40-45	4000	105	WHITE	1/5	1	72,80
145-56214	5207227202278	27-34-40-45	3000	105	WHITE	1/5	1	72,80

ΧΩΝΕΥΤΑ BACKLIGHT UGR19 RECESSED BACKLIGHT UGR19



NEW



60x60cm

Volt: **220-240V 50/60Hz** • LED Type: **SMD2835**

Γωνία Δέσμης Φωτός / Beam Angle: **90°**

Ενεργειακή Κλάση / Energy Class: **D**

Start Time: **0,5sec** • PF > **0,90** • CRI > **90**

Θερμοκρασία Λειτουργίας / Operating Temperature: **-20/+40°C**

Υλικό / Material: **Αλουμίνιο & Πλαστικό / Aluminium & Plastic**

Σύνδεση / Connection: **Καλώδιο / Wire**

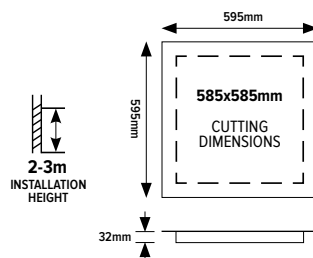

CODE	BARCODE	WATT	KELVIN	LUMEN/WATT	COLOR	PACKING	MOQ	PRICE (€)
145-56320	5207227327872	32	6500	135	WHITE	1/6	1	39,15
145-56321	5207227327896	32	4000	135	WHITE	1/6	1	39,15
145-56322	5207227327919	32	3000	135	WHITE	1/6	1	39,15



NEW



120x30cm

Volt: **220-240V 50/60Hz** • LED Type: **SMD2835**

Γωνία Δέσμης Φωτός / Beam Angle: **90°**

Ενεργειακή Κλάση / Energy Class: **D**

Start Time: **0,5sec** • PF > **0,90** • CRI > **90**

Θερμοκρασία Λειτουργίας / Operating Temperature: **-20/+40°C**

Υλικό / Material: **Αλουμίνιο & Πλαστικό / Aluminium & Plastic**

Σύνδεση / Connection: **Καλώδιο / Wire**

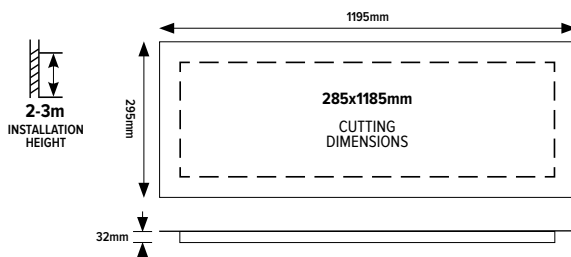

CODE	BARCODE	WATT	KELVIN	LUMEN/WATT	COLOR	PACKING	MOQ	PRICE (€)
145-56323	5207227327933	32	6500	135	WHITE	1/6	1	43,05
145-56324	5207227327957	32	4000	135	WHITE	1/6	1	43,05
145-56325	5207227327971	32	3000	135	WHITE	1/6	1	43,05

ΧΩΝΕΥΤΑ BACKLIGHT UGR19 RECESSED BACKLIGHT UGR19



NEW



60x60cm

Volt: **220-240V 50/60Hz** • LED Type: **SMD2835**

Γωνία Δέσμης Φωτός / Beam Angle: **90°**

Ενεργειακή Κλάση / Energy Class: **E**

Start Time: **0,5sec** • PF > **0,90** • CRI > **80**

Θερμοκρασία Λειτουργίας / Operating Temperature: **-20/+40°C**

Υλικό / Material: **Αλουμίνιο & Πλαστικό / Aluminium & Plastic**

Σύνδεση / Connection: **Καλώδιο / Wire**

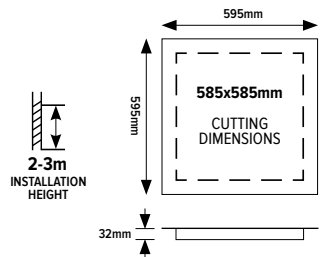

CODE	BARCODE	WATT	KELVIN	LUMEN/WATT	COLOR	PACKING	MOQ	PRICE (€)
145-56330	5207227327995	36	6500	110	WHITE	1/6	1	30,80
145-56331	5207227328015	36	4000	110	WHITE	1/6	1	30,80
145-56332	5207227328039	36	3000	110	WHITE	1/6	1	30,80



NEW



120x30cm

Volt: **220-240V 50/60Hz** • LED Type: **SMD2835**

Γωνία Δέσμης Φωτός / Beam Angle: **90°**

Ενεργειακή Κλάση / Energy Class: **E**

Start Time: **0,5sec** • PF > **0,90** • CRI > **80**

Θερμοκρασία Λειτουργίας / Operating Temperature: **-20/+40°C**

Υλικό / Material: **Αλουμίνιο & Πλαστικό / Aluminium & Plastic**

Σύνδεση / Connection: **Καλώδιο / Wire**

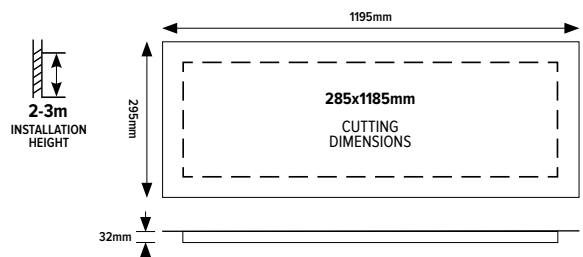

CODE	BARCODE	WATT	KELVIN	LUMEN/WATT	COLOR	PACKING	MOQ	PRICE (€)
145-56333	5207227328053	36	6500	110	WHITE	1/6	1	33,75
145-56334	5207227328077	36	4000	110	WHITE	1/6	1	33,75
145-56335	5207227328091	36	3000	110	WHITE	1/6	1	33,75

ΧΩΝΕΥΤΑ BACKLIGHT 3CCT UGR19 RECESSED BACKLIGHT 3CCT UGR19

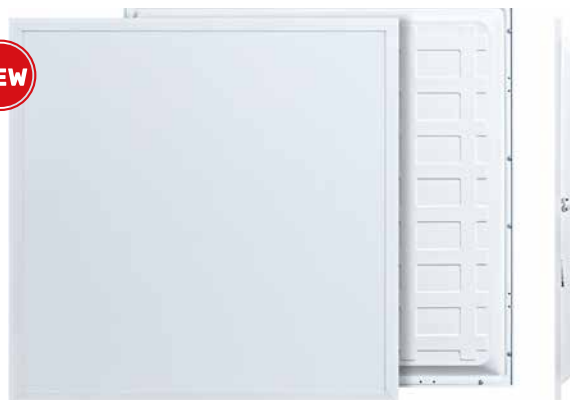

60x60cm

Volt: **220-240V 50/60Hz** • LED Type: **SMD2835**

3CCT: **2700K/4000K/6500K**

Γωνία Δέσμης Φωτός / Beam Angle: **90°**

Ενεργειακή Κλάση / Energy Class: **F**

Start Time: **0,5sec** • PF > **0,90** • CRI > **80**

Θερμοκρασία Λειτουργίας / Operating Temperature: **-20/+40°C**

Υλικό / Material: **Αλουμίνιο & Πλαστικό / Aluminium & Plastic**

Σύνδεση / Connection: **Καλώδιο / Wire**

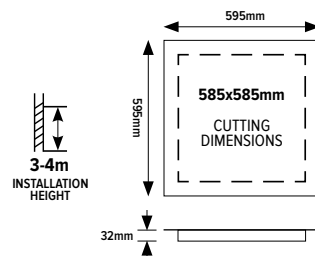

CODE	BARCODE	WATT	KELVIN	LUMEN/WATT	COLOR	PACKING	MOQ	PRICE (€)
145-56350	5207227282942	36	3CCT	135	WHITE	1/5	1	36,65



120x30cm

Volt: **220-240V 50/60Hz** • LED Type: **SMD2835**

3CCT: **2700K/4000K/6500K**

Γωνία Δέσμης Φωτός / Beam Angle: **90°**

Ενεργειακή Κλάση / Energy Class: **F**

Start Time: **0,5sec** • PF > **0,90** • CRI > **80**

Θερμοκρασία Λειτουργίας / Operating Temperature: **-20/+40°C**

Υλικό / Material: **Αλουμίνιο & Πλαστικό / Aluminium & Plastic**

Σύνδεση / Connection: **Καλώδιο / Wire**

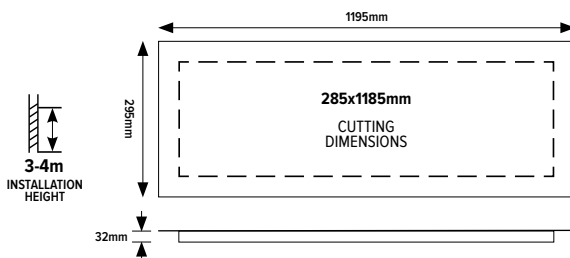

CODE	BARCODE	WATT	KELVIN	LUMEN/WATT	COLOR	PACKING	MOQ	PRICE (€)
145-56351	5207227282966	36	3CCT	135	WHITE	1/5	1	36,65

ΧΩΝΕΥΤΑ BACKLIGHT UGR19 RECESSED BACKLIGHT UGR19



60x60cm

Volt: **220-240V 50/60Hz** • LED Type: **SMD2835**

Γωνία Δέσμης Φωτός / Beam Angle: **90°**

Ενεργειακή Κλάση / Energy Class: **C**

Start Time: **0,5sec** • PF > **0,90** • CRI > **80**

Θερμοκρασία Λειτουργίας / Operating Temperature: **-20/+40°C**

Υλικό / Material: **Αλουμίνιο & Πλαστικό / Aluminium & Plastic**

Σύνδεση / Connection: **Καλώδιο / Wire**

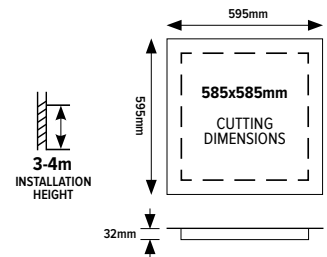

CODE	BARCODE	WATT	KELVIN	LUMEN/WATT	COLOR	PACKING	MOQ	PRICE (€)
145-56310	5207227282980	28	6500	180	WHITE	1/5	1	52,95
145-56311	5207227283000	28	4000	180	WHITE	1/5	1	52,95
145-56312	5207227283024	28	3000	180	WHITE	1/5	1	52,95



120x30cm

Volt: **220-240V 50/60Hz** • LED Type: **SMD2835**

Γωνία Δέσμης Φωτός / Beam Angle: **90°**

Ενεργειακή Κλάση / Energy Class: **C**

Start Time: **0,5sec** • PF > **0,90** • CRI > **80**

Θερμοκρασία Λειτουργίας / Operating Temperature: **-20/+40°C**

Υλικό / Material: **Αλουμίνιο & Πλαστικό / Aluminium & Plastic**

Σύνδεση / Connection: **Καλώδιο / Wire**

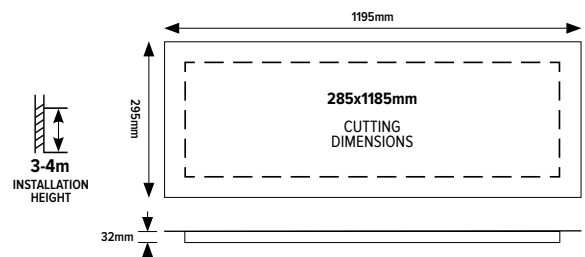

CODE	BARCODE	WATT	KELVIN	LUMEN/WATT	COLOR	PACKING	MOQ	PRICE (€)
145-56313	5207227283048	28	6500	180	WHITE	1/5	1	55,25
145-56314	5207227283062	28	4000	180	WHITE	1/5	1	55,25
145-56315	5207227283086	28	3000	180	WHITE	1/5	1	55,25

ΧΩΝΕΥΤΑ BACKLIGHT TRIDONIC UGR19 RECESSED BACKLIGHT TRIDONIC UGR19



powered by
TRIDONIC
27W 34W 40W 48W

NEW



60x60cm

Volt: **220-240V 50/60Hz** • LED Type: **SMD2835**
Γωνία Δέσμης Φωτός / Beam Angle: **120°**
Ενεργειακή Κλάση / Energy Class: **F**
Start Time: **0,5sec** • PF > **0,90** • CRI > **80**
Θερμοκρασία Λειτουργίας / Operating Temperature: **-20/+40°C**
Υλικό / Material: **Αλουμίνιο & Πλαστικό / Aluminium & Plastic**
Σύνδεση / Connection: **Καλώδιο / Wire**

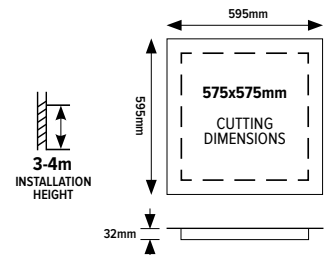

CODE	BARCODE	WATT	KELVIN	LUMEN/WATT	COLOR	PACKING	MOQ	PRICE (€)
145-56230	5207227256820	27-34-40-48	6500	105	WHITE	1/10	1	40,65
145-56231	5207227243400	27-34-40-48	4000	105	WHITE	1/10	1	40,65
145-56232	5207227243424	27-34-40-48	3000	105	WHITE	1/10	1	40,65



powered by
TRIDONIC
27W 34W 40W 45W

NEW



120x30cm

Volt: **220-240V 50/60Hz** • LED Type: **SMD2835**
Γωνία Δέσμης Φωτός / Beam Angle: **120°**
Ενεργειακή Κλάση / Energy Class: **F**
Start Time: **0,5sec** • PF > **0,90** • CRI > **80**
Θερμοκρασία Λειτουργίας / Operating Temperature: **-20/+40°C**
Υλικό / Material: **Αλουμίνιο & Πλαστικό / Aluminium & Plastic**
Σύνδεση / Connection: **Καλώδιο / Wire**

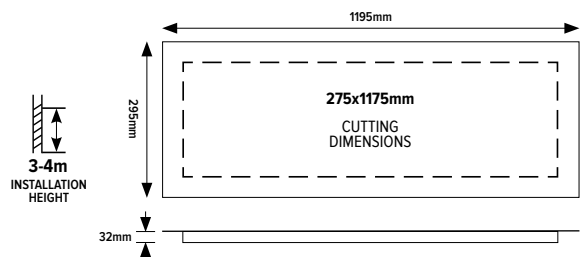

CODE	BARCODE	WATT	KELVIN	LUMEN/WATT	COLOR	PACKING	MOQ	PRICE (€)
145-56233	5207227256837	27-34-40-45	6500	105	WHITE	1/5	1	53,85
145-56234	5207227246333	27-34-40-45	4000	105	WHITE	1/5	1	53,85
145-56235	5207227246357	27-34-40-45	3000	105	WHITE	1/5	1	53,85

ΕΞΩΤΕΡΙΚΑ BACKLIGHT TRIDONIC UGR19 SURFACE BACKLIGHT TRIDONIC UGR19



powered by
TRIDONIC
27W 34W 40W 48W

60x60cm

Volt: **220-240V 50/60Hz** • LED Type: **SMD2835**

Γωνία Δέσμης Φωτός / Beam Angle: **120°**

Ενεργειακή Κλάση / Energy Class: **F**

Start Time: **0,5sec** • PF > **0,90** • CRI > **80**

Θερμοκρασία Λειτουργίας / Operating Temperature: **-20/+40°C**

Υλικό / Material: **Αλουμίνιο & Πλαστικό / Aluminium & Plastic**

Σύνδεση / Connection: **Καλώδιο / Wire**

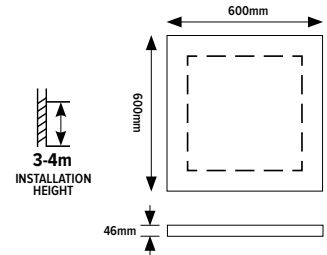

CODE	BARCODE	WATT	KELVIN	LUMEN/WATT	COLOR	PACKING	MOQ	PRICE (€)
145-56240	5207227256844	27-34-40-48	6500	105	WHITE	1/7	1	52,85
145-56241	5207227256851	27-34-40-48	4000	105	WHITE	1/7	1	52,85
145-56242	5207227256875	27-34-40-48	3000	105	WHITE	1/7	1	52,85
145-56243	5207227256868	27-34-40-48	6500	105	BLACK	1/7	1	52,85
145-56244	5207227256882	27-34-40-48	4000	105	BLACK	1/7	1	52,85
145-56245	5207227256899	27-34-40-48	3000	105	BLACK	1/7	1	52,85



powered by
TRIDONIC
27W 34W 40W 45W

120x30cm

Volt: **220-240V 50/60Hz** • LED Type: **SMD2835**

Γωνία Δέσμης Φωτός / Beam Angle: **120°**

Ενεργειακή Κλάση / Energy Class: **F**

Start Time: **0,5sec** • PF > **0,90** • CRI > **80**

Θερμοκρασία Λειτουργίας / Operating Temperature: **-20/+40°C**

Υλικό / Material: **Αλουμίνιο & Πλαστικό / Aluminium & Plastic**

Σύνδεση / Connection: **Καλώδιο / Wire**

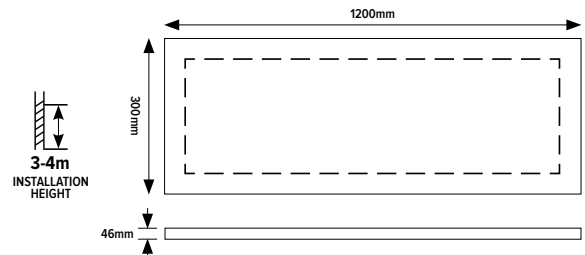

CODE	BARCODE	WATT	KELVIN	LUMEN/WATT	COLOR	PACKING	MOQ	PRICE (€)
145-56250	5207227256905	27-34-40-45	6500	105	WHITE	1/5	1	65,45
145-56251	5207227256912	27-34-40-45	4000	105	WHITE	1/5	1	65,45
145-56252	5207227256929	27-34-40-45	3000	105	WHITE	1/5	1	65,45
145-56253	5207227256936	27-34-40-45	6500	105	BLACK	1/5	1	65,45
145-56254	5207227256943	27-34-40-45	4000	105	BLACK	1/5	1	65,45
145-56255	5207227256950	27-34-40-45	3000	105	BLACK	1/5	1	65,45

ΧΩΝΕΥΤΑ BACKLIGHT UGR19 RECESSED BACKLIGHT UGR19



30x60cm

Volt: **220-240V 50/60Hz** • LED Type: **SMD2835**

Γωνία Δέσμης Φωτός / Beam Angle: **120°**

Ενεργειακή Κλάση / Energy Class: **F**

Start Time: **0,5sec** • PF > **0,90** • CRI > **80**

Θερμοκρασία Λειτουργίας / Operating Temperature: **-20/+40°C**

Υλικό / Material: **Αλουμίνιο & Πλαστικό / Aluminium & Plastic**

Σύνδεση / Connection: **Καλώδιο / Wire**

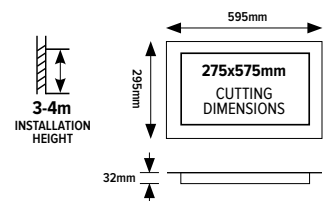

CODE	BARCODE	WATT	KELVIN	LUMEN/WATT	COLOR	PACKING	MOQ	PRICE (€)
145-56140	5207227026119	30	6500	105	WHITE	1/10	1	22,45
145-56141	5207227026133	30	4000	105	WHITE	1/10	1	22,45
145-56142	5207227123108	30	3000	105	WHITE	1/10	1	22,45



60x60cm

Volt: **220-240V 50/60Hz** • LED Type: **SMD2835**

Γωνία Δέσμης Φωτός / Beam Angle: **120°**

Ενεργειακή Κλάση / Energy Class: **F**

Start Time: **0,5sec** • PF > **0,90** • CRI > **80**

Θερμοκρασία Λειτουργίας / Operating Temperature: **-20/+40°C**

Υλικό / Material: **Αλουμίνιο & Πλαστικό / Aluminium & Plastic**

Σύνδεση / Connection: **Καλώδιο / Wire**

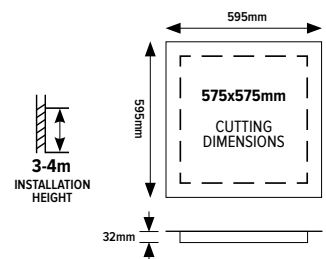

CODE	BARCODE	WATT	KELVIN	LUMEN/WATT	COLOR	PACKING	MOQ	PRICE (€)
145-56143	5207227123115	48	6500	105	WHITE	1/10	1	32,95
145-56144	5207227123139	48	4000	105	WHITE	1/10	1	32,95
145-56145	5207227123146	48	3000	105	WHITE	1/10	1	32,95

ΧΩΝΕΥΤΑ BACKLIGHT UGR19 RECESSED BACKLIGHT UGR19



120x30cm

Volt: **220-240V 50/60Hz** • LED Type: **SMD2835**

Γωνία Δέσμης Φωτός / Beam Angle: **120°**

Ενεργειακή Κλάση / Energy Class: **F**

Start Time: **0,5sec** • PF > **0,90** • CRI > **80**

Θερμοκρασία Λειτουργίας / Operating Temperature: **-20/+40°C**

Υλικό / Material: **Αλουμίνιο & Πλαστικό / Aluminium & Plastic**

Σύνδεση / Connection: **Καλώδιο / Wire**

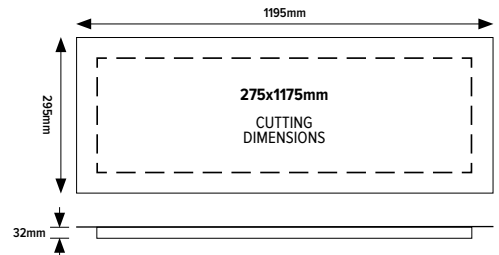

CODE	BARCODE	WATT	KELVIN	LUMEN/WATT	COLOR	PACKING	MOQ	PRICE (€)
145-56146	5207227123153	45	6500	105	WHITE	1/5	1	42,25
145-56147	5207227123177	45	4000	105	WHITE	1/5	1	42,25
145-56148	5207227123092	45	3000	105	WHITE	1/5	1	42,25



ΕΞΩΤΕΡΙΚΑ BACKLIGHT UGR19 SURFACE BACKLIGHT UGR19



30x60cm

Volt: **220-240V 50/60Hz** • LED Type: **SMD2835**

Γωνία Δέσμης Φωτός / Beam Angle: **120°**

Ενεργειακή Κλάση / Energy Class: **F**

Start Time: **0,5sec** • PF > **0,90** • CRI > **80**

Θερμοκρασία Λειτουργίας / Operating Temperature: **-20/+40°C**

Υλικό / Material: **Αλουμίνιο & Πλαστικό / Aluminium & Plastic**

Σύνδεση / Connection: **Καλώδιο / Wire**

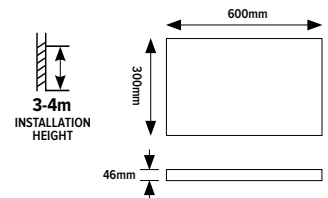

CODE	BARCODE	WATT	KELVIN	LUMEN/WATT	COLOR	PACKING	MOQ	PRICE (€)
145-56150	5207227159206	30	6500	105	WHITE	1/5	1	33,65
145-56151	5207227159220	30	4000	105	WHITE	1/5	1	33,65
145-56152	5207227159244	30	3000	105	WHITE	1/5	1	33,65



60x60cm

Volt: **220-240V 50/60Hz** • LED Type: **SMD2835**

Γωνία Δέσμης Φωτός / Beam Angle: **120°**

Ενεργειακή Κλάση / Energy Class: **F**

Start Time: **0,5sec** • PF > **0,90** • CRI > **80**

Θερμοκρασία Λειτουργίας / Operating Temperature: **-20/+40°C**

Υλικό / Material: **Αλουμίνιο & Πλαστικό / Aluminium & Plastic**

Σύνδεση / Connection: **Καλώδιο / Wire**

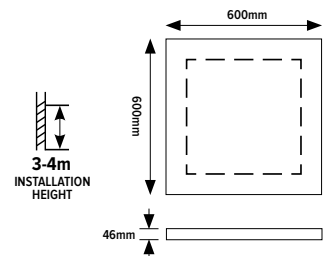

CODE	BARCODE	WATT	KELVIN	LUMEN/WATT	COLOR	PACKING	MOQ	PRICE (€)
145-56153	5207227159268	48	6500	105	WHITE	1/7	1	43,85
145-56154	5207227159282	48	4000	105	WHITE	1/7	1	43,85
145-56155	5207227159305	48	3000	105	WHITE	1/7	1	43,85
145-56223	5207227256769	48	6500	105	BLACK	1/7	1	43,85
145-56224	5207227256776	48	4000	105	BLACK	1/7	1	43,85
145-56225	5207227256783	48	3000	105	BLACK	1/7	1	43,85

ΕΞΩΤΕΡΙΚΑ BACKLIGHT UGR19 SURFACE BACKLIGHT UGR19



120x30cm

Volt: **220-240V 50/60Hz** • LED Type: **SMD2835**

Γωνία Δέσμης Φωτός / Beam Angle: **120°**

Ενεργειακή Κλάση / Energy Class: **F**

Start Time: **0,5sec** • PF > **0,90** • CRI > **80**

Θερμοκρασία Λειτουργίας / Operating Temperature: **-20/+40°C**

Υλικό / Material: **Αλουμίνιο & Πλαστικό / Aluminium & Plastic**

Σύνδεση / Connection: **Καλώδιο / Wire**

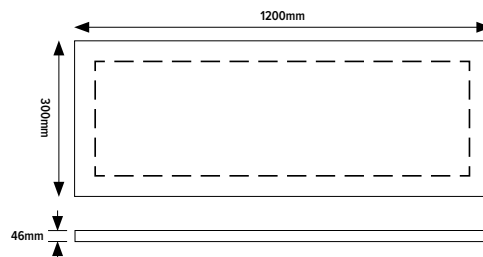
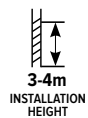

CODE	BARCODE	WATT	KELVIN	LUMEN/WATT	COLOR	PACKING	MOQ	PRICE (€)
145-56156	5207227159329	45	6500	105	WHITE	1/5	1	53,25
145-56157	5207227159343	45	4000	105	WHITE	1/5	1	53,25
145-56158	5207227159367	45	3000	105	WHITE	1/5	1	53,25
145-56226	5207227256790	45	6500	105	BLACK	1/5	1	53,25
145-56227	5207227256806	45	4000	105	BLACK	1/5	1	53,25
145-56228	5207227256813	45	3000	105	BLACK	1/5	1	53,25



ΧΩΝΕΥΤΑ SLIM RECESSED SLIM BACKLIGHT



60x60cm

Volt: **220-240V 50/60Hz** • LED Type: **SMD4014**

Γωνία Δέσμης Φωτός / Beam Angle: **110°**

Ενεργειακή Κλάση / Energy Class: **E**

Start Time: **0,5sec** • PF > **0,90** • CRI > **80**

Θερμοκρασία Λειτουργίας / Operating Temperature: **-20/+40°C**

Υλικό / Material: **Αλουμίνιο & Πλαστικό / Aluminium & Plastic**

Σύνδεση / Connection: **Καλώδιο / Wire**

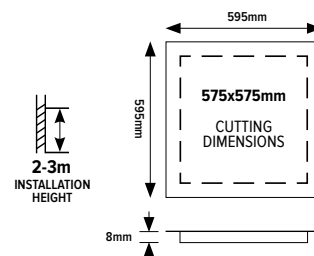

CODE	BARCODE	WATT	KELVIN	LUMEN/WATT	COLOR	PACKING	MOQ	PRICE (€)
145-56160	5207227033872	40	6500	115	WHITE	1/5	1	31,95
145-56161	5207227033889	40	4000	113	WHITE	1/5	1	31,95
145-56162	5207227033902	40	3000	110	WHITE	1/5	1	31,95



120x30cm

Volt: **220-240V 50/60Hz** • LED Type: **SMD4014**

Γωνία Δέσμης Φωτός / Beam Angle: **110°**

Ενεργειακή Κλάση / Energy Class: **F**

Start Time: **0,5sec** • PF > **0,90** • CRI > **80**

Θερμοκρασία Λειτουργίας / Operating Temperature: **-20/+40°C**

Υλικό / Material: **Αλουμίνιο & Πλαστικό / Aluminium & Plastic**

Σύνδεση / Connection: **Καλώδιο / Wire**

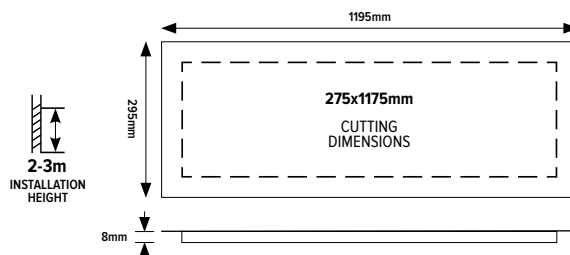

CODE	BARCODE	WATT	KELVIN	LUMEN/WATT	COLOR	PACKING	MOQ	PRICE (€)
145-56163	5207227058561	40	6500	115	WHITE	1/5	1	37,75
145-56164	5207227058585	40	4000	113	WHITE	1/5	1	37,75
145-56165	5207227058608	40	3000	110	WHITE	1/5	1	37,75

ΧΩΝΕΥΤΑ SLIM UGR19 RECESSED SLIM BACKLIGHT UGR19



60x60cm

Volt: **220-240V 50/60Hz** • LED Type: **SMD4014**

Γωνία Δέσμης Φωτός / Beam Angle: **90°**

Ενεργειακή Κλάση / Energy Class: **F**

Start Time: **0,5sec** • PF > **0,90** • CRI > **80**

Θερμοκρασία Λειτουργίας / Operating Temperature: **-20/+40°C**

Υλικό / Material: **Αλουμίνιο & Πλαστικό / Aluminium & Plastic**

Σύνδεση / Connection: **Καλώδιο / Wire**

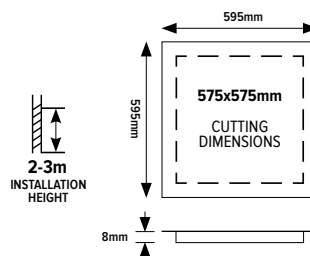

CODE	BARCODE	WATT	KELVIN	LUMEN/WATT	COLOR	PACKING	MOQ	PRICE (€)
145-56170	5207227061691	40	6500	110	WHITE	1/5	1	33,45
145-56171	5207227061714	40	4000	105	WHITE	1/5	1	33,45
145-56172	5207227061738	40	3000	95	WHITE	1/5	1	33,45



120x30cm

Volt: **220-240V 50/60Hz** • LED Type: **SMD4014**

Γωνία Δέσμης Φωτός / Beam Angle: **90°**

Ενεργειακή Κλάση / Energy Class: **F**

Start Time: **0,5sec** • PF > **0,90** • CRI > **80**

Θερμοκρασία Λειτουργίας / Operating Temperature: **-20/+40°C**

Υλικό / Material: **Αλουμίνιο & Πλαστικό / Aluminium & Plastic**

Σύνδεση / Connection: **Καλώδιο / Wire**

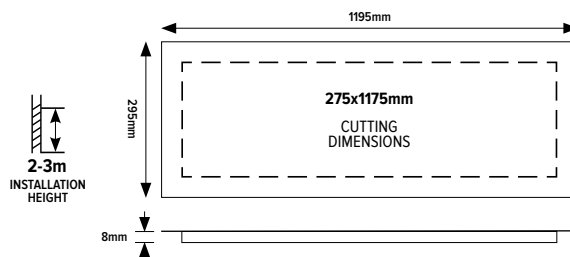

CODE	BARCODE	WATT	KELVIN	LUMEN/WATT	COLOR	PACKING	MOQ	PRICE (€)
145-56173	5207227070082	40	6500	110	WHITE	1/5	1	39,85
145-56174	5207227070105	40	4000	105	WHITE	1/5	1	39,85
145-56175	5207227070129	40	3000	95	WHITE	1/5	1	39,85

ΧΩΝΕΥΤΑ BACKLIGHT TRIDONIC DALI UGR19 RECESSED BACKLIGHT TRIDONIC DALI UGR19



powered by
TRIDONIC

NEW



60x60cm

Volt: **220-240V 50/60Hz** • LED Type: **DALI SMD2835**

Γωνία Δέσμης Φωτός / Beam Angle: **120°**

Ενεργειακή Κλάση / Energy Class: **F**

Start Time: **0,5sec** • PF > **0,90** • CRI > **80**

Θερμοκρασία Λειτουργίας / Operating Temperature: **-20/+40°C**

Υλικό / Material: **Αλουμίνιο & Πλαστικό / Aluminium & Plastic**

Σύνδεση / Connection: **Καλώδιο / Wire**

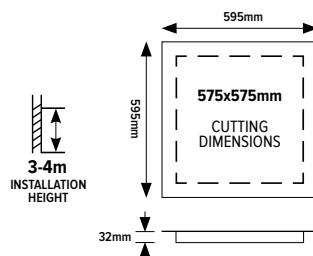

CODE	BARCODE	WATT	KELVIN	LUMEN/WATT	COLOR	PACKING	MOQ	PRICE (€)
145-56300	5207227268489	50	6500	105	WHITE	1/10	1	96,45
145-56301	5207227268496	50	4000	105	WHITE	1/10	1	96,45
145-56302	5207227268502	50	3000	105	WHITE	1/10	1	96,45



powered by
TRIDONIC

NEW



120x30cm

Volt: **220-240V 50/60Hz** • LED Type: **SMD2835**

Γωνία Δέσμης Φωτός / Beam Angle: **120°**

Ενεργειακή Κλάση / Energy Class: **F**

Start Time: **0,5sec** • PF > **0,90** • CRI > **80**

Θερμοκρασία Λειτουργίας / Operating Temperature: **-20/+40°C**

Υλικό / Material: **Αλουμίνιο & Πλαστικό / Aluminium & Plastic**

Σύνδεση / Connection: **Καλώδιο / Wire**

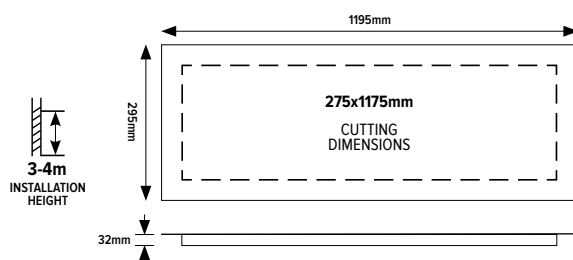

CODE	BARCODE	WATT	KELVIN	LUMEN/WATT	COLOR	PACKING	MOQ	PRICE (€)
145-56303	5207227268519	50	6500	105	WHITE	1/5	1	98,85
145-56304	5207227268526	50	4000	105	WHITE	1/5	1	98,85
145-56305	5207227268533	50	3000	105	WHITE	1/5	1	98,85

ΑΞΕΣΟΥΑΡ ΓΙΑ LED PANEL ACCESSORIES FOR LED PANEL

ΕΞΩΤΕΡΙΚΗ ΒΑΣΗ

SURFACE BASE

Υλικό / Material:

Αλουμίνιο & Πλαστικό / Aluminium & Plastic



CODE	BARCODE	DIMENSIONS	WEIGHT	COLOR	PACKING	MOQ	PRICE (€)
145-56196	5207227026188	600x600x43mm	0,47kg	WHITE	1/25	1	10,55
145-56390	5207227280177	600x600x70mm	0,8kg	WHITE	1/10	1	16,25

ΕΞΩΤΕΡΙΚΗ ΒΑΣΗ

SURFACE BASE

Υλικό / Material:

Αλουμίνιο & Πλαστικό / Aluminium & Plastic



CODE	BARCODE	DIMENSIONS	WEIGHT	COLOR	PACKING	MOQ	PRICE (€)
145-56197	5207227031298	1200x300x43mm	0,57kg	WHITE	1/25	1	13,45
145-56391	5207227280191	1200x300x70mm	0,99kg	WHITE	1/10	1	20,85

ΣΤΕΦΑΝΙ ΥΠΟΣΤΗΡΙΞΗΣ PANEL 600X600

FRAME ADAPTOR PANEL 600X600

625x625mm

Βάρος / Weight: **0,230kg**

Υλικό / Material: **Αλουμίνιο / Aluminium**

CODE	BARCODE	COLOR	PACKING	MOQ	PRICE (€)
145-68095	5207227060335	SILVER	1/1	1	27,85

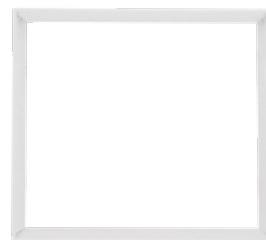

ΕΞΑΡΤΗΜΑ ΣΤΗΡΙΞΗΣ ΓΙΑ ΚΡΕΜΑΣΤΟ ΦΩΤΙΣΤΙΚΟ

METAL SUSPENDING WIRE

Υλικό / Material:

Μέταλλο / Metal

CODE	BARCODE	PACKING	MOQ	PRICE (€)
145-56190	5206139052278	1/100	1	4,65



ΕΞΑΡΤΗΜΑ ΣΤΗΡΙΞΗΣ ΓΙΑ ΓΥΨΟΣΑΝΙΔΑ & ΓΙΑ BACKLIGHT (CLIP)

SPRING FASTENER & LED BACKLIGHT (CLIP)

Υλικό / Material:

Μέταλλο / Metal

CODE	BARCODE	PACKING	MOQ	PRICE (€)	
145-56191	5207227058615	CLIP	1/100	1	2,70
145-56192	5207227158827	BACKLIGHT CLIP	1/400	1	3,25



145-56191



145-56192

ΤΡΟΦΟΔΟΤΙΚΑ ΓΙΑ LED PANEL DRIVERS FOR LED PANEL



145-56290



145-56291

Volt: **220-240V 50/60Hz**

Output: **126V DC • PF > 0.95**

Θερμοκρασία Λειτουργίας / Operating Temperature: **-20/+40°C**

Υλικό / Material: **Μεταλλικό / Metal**



CODE	BARCODE	WATT	DIMENSIONS	DIMMING	COLOR	PACKING	MOQ	PRICE (€)
145-56290	5207227202407	32-36-42-48	230x30x20mm	1-10V DC	SILVER	1/50	1	22,65
145-56291	5207227202414	50	230x30x20mm	DALI	SILVER	1/50	1	53,25



Volt: **220-240V 50/60Hz**

Output: **3-42V DC • PF > 0.95**

Θερμοκρασία Λειτουργίας / Operating Temperature: **-20/+40°C**

Χρόνος φόρτισης / Battery Charging Time: **24h**

Υλικό / Material: **Πλαστικό / Plastic**



CODE	BARCODE	WATT	DIMENSIONS	DIMMING	COLOR	PACKING	MOQ	PRICE (€)
145-56193	5207227124006	40	103x68x30mm	Dali	WHITE	1/48	1	43,85



Volt: **220-240V 50/60Hz**

Output: **3-42V DC • PF > 0.95**

Θερμοκρασία Λειτουργίας / Operating Temperature: **-20/+40°C**

Υλικό / Material: **Πλαστικό / Plastic**



CODE	BARCODE	WATT	DIMENSIONS	DIMMING	COLOR	PACKING	MOQ	PRICE (€)
145-56194	5207227124013	40	103x68x30mm	Dali & 1-10V DC	WHITE	1/48	1	52,25

ΑΝΤΑΛΛΑΚΤΙΚΑ ΓΙΑ LED PANEL SPARE PARTS FOR LED PANEL



ΤΡΟΦΟΔΟΤΙΚΟ LED LED DRIVER

Volt: **100-240V 50/60Hz**

Output: **25-42V DC • PF > 0.95**

Θερμοκρασία Λειτουργίας / Operating Temperature: **-20/+40°C**

Υλικό / Material: **Πλαστικό / Plastic**



CODE	BARCODE	WATT	DIMENSIONS	DIMMING	COLOR	PACKING	MOQ	PRICE (€)
145-56195	5206139044532	40	65x140x30mm	1-10V DC	WHITE	1/50	1	33,65

ΤΡΟΦΟΔΟΤΙΚΟ LED LED DRIVER

Volt: **200-240V 50/60Hz**

Output: **27-40V DC • PF > 0,90**

Θερμοκρασία Λειτουργίας / Operating Temperature: **-20/+45°C**

Υλικό / Material: **Πλαστικό / Plastic**

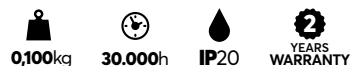

CODE	BARCODE	WATT	DIMENSIONS	Amperage	COLOR	PACKING	MOQ	PRICE (€)
145-56139	5207227038020	40	116x40x30mm	950mA	WHITE/BLUE	1/80	1	15,65

ΤΡΟΦΟΔΟΤΙΚΟ LED LED DRIVER

Volt: **175-265V 50/60Hz**

Θερμοκρασία Λειτουργίας / Operating Temperature: **-20/+40°C**

Υλικό / Material: **Πλαστικό / Plastic**



CODE	BARCODE	WATT	DIMENSIONS	COLOR	PACKING	MOQ	PRICE (€)
145-56186	5207227283123	45 / 48	70x30x20mm	WHITE/ORANGE	1/50	1	4,85

ΤΡΟΦΟΔΟΤΙΚΟ ΜΠΑΤΑΡΙΑΣ UNIVERSAL 12-80W UNIVERSAL BATTERY DRIVER 12-80W

Volt: **220-240V 50/60Hz**

Output: **24-80V DC**

Θερμοκρασία Λειτουργίας / Operating Temperature: **-25/+70°C**

Τύπος Μπαταρίας / Battery type: **Lithium 7.4V 2200mAh**

Χρόνος φόρτισης / Battery Charging Time: **24h**

Υλικό / Material: **Πλαστικό / Plastic**



CODE	BARCODE	WATT	DIMENSIONS	PF	COLOR	PACKING	MOQ	PRICE (€)
145-56180	5207227058882	12-80W	202x41x27mm	>0.90	WHITE	1/50	1	27,25





Φωτιστικά Χωνευτά
LED SMD & COB

LED SMD & COB
Recessed Fixtures

ΧΩΝΕΥΤΑ LED RECESSED LED



Ø40x50mm

Volt: **220-240V 50/60Hz** • Output: **25-42V DC** • LED Type: **COB**
 Γωνία Δέσμης Φωτός / Beam Angle: **36°**
 Ενεργειακή Κλάση / Energy Class: **F**
 Start Time: **0,5sec** • PF > **0,50** • CRI > **80**
 Θερμοκρασία Λειτουργίας / Operating Temperature: **-10/+60°C**
 Υλικό / Material: **Αλουμίνιο & Πλαστικό / Aluminium & Plastic**

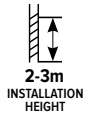
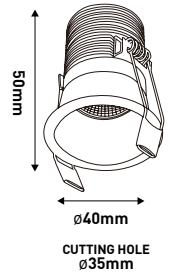

CODE	BARCODE	WATT	KELVIN	LUMEN/WATT	COLOR	PACKING	MOQ	PRICE (€)
145-65011	5207227282751	5	4000	100	WHITE	1/50	1	16,25
145-65012	5207227282768	5	3000	100	WHITE	1/50	1	16,25



Ø60x60mm

Volt: **220-240V 50/60Hz** • Output: **33-40V DC** • LED Type: **COB**
 Γωνία Δέσμης Φωτός / Beam Angle: **36°**
 Ενεργειακή Κλάση / Energy Class: **F**
 Start Time: **0,5sec** • PF > **0,50** • CRI > **80**
 Θερμοκρασία Λειτουργίας / Operating Temperature: **-10/+60°C**
 Υλικό / Material: **Αλουμίνιο & Πλαστικό / Aluminium & Plastic**

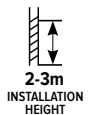
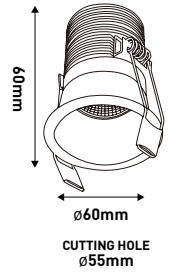

CODE	BARCODE	WATT	KELVIN	LUMEN/WATT	COLOR	PACKING	MOQ	PRICE (€)
145-65014	5207227282713	12	4000	100	WHITE	1/50	1	23,65
145-65015	5207227282720	12	3000	100	WHITE	1/50	1	23,65



Ø75x75mm

Volt: **220-240V 50/60Hz** • Output: **33-40V DC** • LED Type: **COB**
 Γωνία Δέσμης Φωτός / Beam Angle: **36°**
 Ενεργειακή Κλάση / Energy Class: **F**
 Start Time: **0,5sec** • PF > **0,50** • CRI > **80**
 Θερμοκρασία Λειτουργίας / Operating Temperature: **-10/+60°C**
 Υλικό / Material: **Αλουμίνιο & Πλαστικό / Aluminium & Plastic**

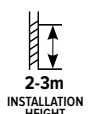
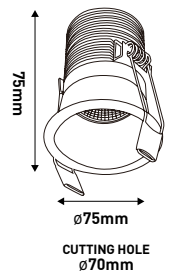

CODE	BARCODE	WATT	KELVIN	LUMEN/WATT	COLOR	PACKING	MOQ	PRICE (€)
145-65017	5207227282744	18	4000	100	WHITE	1/20	1	35,95
145-65018	5207227282737	18	3000	100	WHITE	1/20	1	35,95

ΧΩΝΕΥΤΑ ΜΕ ΚΙΝΗΤΗ ΒΑΣΗ LED RECESSED LED WITH MOVABLE BASE



Ø110x120mm

Volt: **220-240V 50/60Hz** • Output: **33-40V DC** • LED Type: **COB**

Γωνία Δέσμης Φωτός / Beam Angle: **36°**

Ενεργειακή Κλάση / Energy Class: **F**

Start Time: **0,5sec** • PF > **0,50** • CRI > **80**

Θερμοκρασία Λειτουργίας / Operating Temperature: **-10/+60°C**

Υλικό / Material: **Αλουμίνιο & Πλαστικό / Aluminium & Plastic**

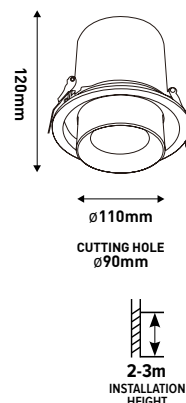

CODE	BARCODE	WATT	KELVIN	LUMEN/WATT	COLOR	PACKING	MOQ	PRICE (€)
145-65020	5207227282775	12	4000	100	WHITE	1/20	1	38,65
145-65021	5207227282782	12	3000	100	WHITE	1/20	1	38,65



Ø110x120mm

Volt: **220-240V 50/60Hz** • Output: **33-40V DC** • LED Type: **COB**

3CCT: **3000K/4000K/6500**

Γωνία Δέσμης Φωτός / Beam Angle: **36°**

Ενεργειακή Κλάση / Energy Class: **F**

Start Time: **0,5sec** • PF > **0,50** • CRI > **80**

Θερμοκρασία Λειτουργίας / Operating Temperature: **-10/+60°C**

Υλικό / Material: **Αλουμίνιο & Πλαστικό / Aluminium & Plastic**

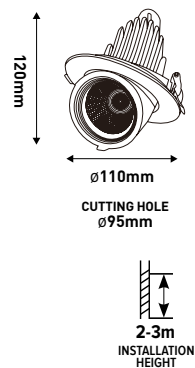

CODE	BARCODE	WATT	KELVIN	LUMEN/WATT	COLOR	PACKING	MOQ	PRICE (€)
145-65022	5207227282799	20	3CCT	100	WHITE	1/20	1	32,85



Ø134x120mm

Volt: **220-240V 50/60Hz** • Output: **33-40V DC** • LED Type: **COB**

3CCT: **3000K/4000K/6500**

Γωνία Δέσμης Φωτός / Beam Angle: **36°**

Ενεργειακή Κλάση / Energy Class: **F**

Start Time: **0,5sec** • PF > **0,90** • CRI > **80**

Θερμοκρασία Λειτουργίας / Operating Temperature: **-10/+60°C**

Υλικό / Material: **Αλουμίνιο & Πλαστικό / Aluminium & Plastic**

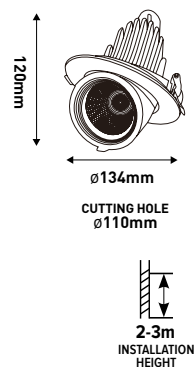

CODE	BARCODE	WATT	KELVIN	LUMEN/WATT	COLOR	PACKING	MOQ	PRICE (€)
145-65023	5207227282805	30	3CCT	100	WHITE	1/20	1	35,25

ΧΩΝΕΥΤΑ LED 3CCT RECESSED LED 3CCT



Ø130x68mm

Volt: **220-240V 50/60Hz** • Output: **33-40V DC** • LED Type: **COB**
3CCT: **3000K/4000K/6500K**

Γωνία Δέσμης Φωτός / Beam Angle: **60°** • Ενεργειακή Κλάση / Energy Class: **F**
Start Time: **0,5sec** • PF > **0,50** • CRI > **80**

Θερμοκρασία Λειτουργίας / Operating Temperature: **-10/+60°C**

Υλικό / Material: **Αλουμίνιο & Πλαστικό / Aluminium & Plastic**

Σύνδεση / Connection: **Καλώδιο / Wire**

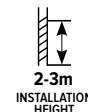
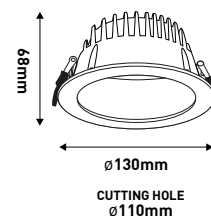

CODE	BARCODE	WATT	KELVIN	LUMEN/WATT	COLOR	PACKING	MOQ	PRICE (€)
145-65200	5207227282843	15	3CCT	100	WHITE	1/20	1	41,85



Ø165x90mm

Volt: **220-240V 50/60Hz** • Output: **33-40V DC** • LED Type: **COB**
3CCT: **3000K/4000K/6500K**

Γωνία Δέσμης Φωτός / Beam Angle: **60°** • Ενεργειακή Κλάση / Energy Class: **F**
Start Time: **0,5sec** • PF > **0,90** • CRI > **80**

Θερμοκρασία Λειτουργίας / Operating Temperature: **-10/+60°C**

Υλικό / Material: **Αλουμίνιο & Πλαστικό / Aluminium & Plastic**

Σύνδεση / Connection: **Καλώδιο / Wire**

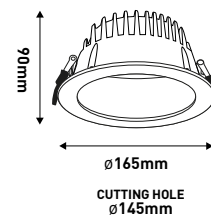

CODE	BARCODE	WATT	KELVIN	LUMEN/WATT	COLOR	PACKING	MOQ	PRICE (€)
145-65201	5207227282829	20	3CCT	100	WHITE	1/20	1	52,35



Ø220x105mm

Volt: **220-240V 50/60Hz** • Output: **33-40V DC** • LED Type: **COB**
3CCT: **3000K/4000K/6500K**

Γωνία Δέσμης Φωτός / Beam Angle: **60°** • Ενεργειακή Κλάση / Energy Class: **F**
Start Time: **0,5sec** • PF > **0,90** • CRI > **80**

Θερμοκρασία Λειτουργίας / Operating Temperature: **-10/+60°C**

Υλικό / Material: **Αλουμίνιο & Πλαστικό / Aluminium & Plastic**

Σύνδεση / Connection: **Καλώδιο / Wire**

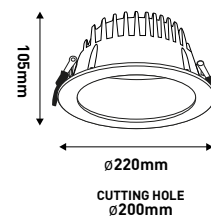

CODE	BARCODE	WATT	KELVIN	LUMEN/WATT	COLOR	PACKING	MOQ	PRICE (€)
145-65202	5207227282836	40	3CCT	100	WHITE	1/10	1	57,65

ΧΩΝΕΥΤΑ LED 3CCT RECESSED LED 3CCT



Ø90x42mm

Volt: **220-240V 50/60Hz** • Output: **33-40V DC** • LED Type: **COB**
3CCT: **3000K/4000K/6500K**

Γωνία Δέσμης Φωτός / Beam Angle: **60°** • Ενεργειακή Κλάση / Energy Class: **F**
Start Time: **0,5sec** • PF > **0,50** • CRI > **80**

Θερμοκρασία Λειτουργίας / Operating Temperature: **-10/+60°C**

Υλικό / Material: **Αλουμίνιο & Πλαστικό / Aluminium & Plastic**

Σύνδεση / Connection: **Καλώδιο / Wire**

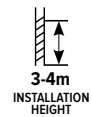
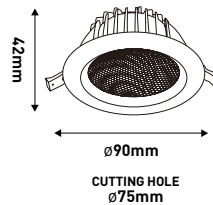

CODE	BARCODE	WATT	KELVIN	LUMEN/WATT	COLOR	PACKING	MOQ	PRICE (€)
145-65210	5207227282850	10	3CCT	100	WHITE	1/20	1	23,65



Ø225x100mm

Volt: **220-240V 50/60Hz** • Output: **33-40V DC** • LED Type: **COB**
3CCT: **3000K/4000K/6500K**

Γωνία Δέσμης Φωτός / Beam Angle: **60°** • Ενεργειακή Κλάση / Energy Class: **F**
Start Time: **0,5sec** • PF > **0,90** • CRI > **80**

Θερμοκρασία Λειτουργίας / Operating Temperature: **-10/+60°C**

Υλικό / Material: **Αλουμίνιο & Πλαστικό / Aluminium & Plastic**

Σύνδεση / Connection: **Καλώδιο / Wire**

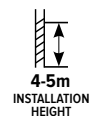
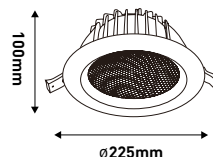

CODE	BARCODE	WATT	KELVIN	LUMEN/WATT	COLOR	PACKING	MOQ	PRICE (€)
145-65211	5207227282867	35	3CCT	100	WHITE	1/10	1	56,45



Ø88x60mm

Volt: **220-240V 50/60Hz** • Output: **25-42V DC** • LED Type: **COB**
3CCT: **3000K/4000K/6500K**

Γωνία Δέσμης Φωτός / Beam Angle: **60°** • Ενεργειακή Κλάση / Energy Class: **F**
Start Time: **0,5sec** • PF > **0,50** • CRI > **80**

Θερμοκρασία Λειτουργίας / Operating Temperature: **-10/+60°C**

Υλικό / Material: **Αλουμίνιο & Πλαστικό / Aluminium & Plastic**

Σύνδεση / Connection: **Καλώδιο / Wire**

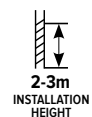
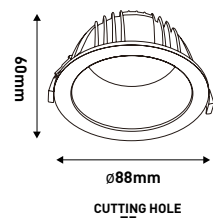

CODE	BARCODE	WATT	KELVIN	LUMEN/WATT	COLOR	PACKING	MOQ	PRICE (€)
145-68902	5207227282751	7	3CCT	100	WHITE	1/20	1	24,55

ΧΩΝΕΥΤΑ LED 4CCT RECESSED LED 4CCT



LIFUD
LED Driver

4
CCT

Ø90x45mm

Volt: **220-240V 50/60Hz** • Output: **60-100V DC**

LED Type: **SMD2835**

4CCT: **2700K/3000K/4000K/6000K**

Γωνία Δέσμης Φωτός / Beam Angle: **90°**

Ενεργειακή Κλάση / Energy Class: **E**

Start Time: **0,5sec** • PF > **0,93** • CRI > **80**

Θερμοκρασία Λειτουργίας / Operating Temperature: **-20/+45°C**

Fire Rated 90min / Πυράντοχο για 90 λεπτά

Υλικό / Material: **Aluminum+Iron / Αλουμίνιο & Μέταλλο**

Σύνδεση / Connection: **Push fit terminal / Ταχεία σύνδεση**

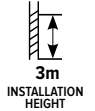
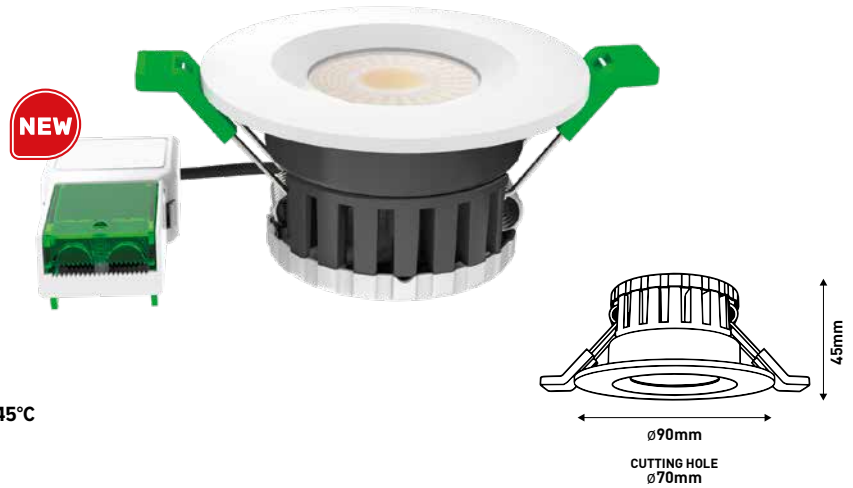

CODE	BARCODE	WATT	KELVIN	LUMEN/WATT	COLOR	PACKING	MOQ	PRICE (€)
145-68900	5207227271151	5/8	4CCT	110	WHITE/BLACK	1/48	1	21,35



ΧΩΝΕΥΤΑ ΓΥΨΟΣΑΝΙΔΑΣ LED 3CCT RECESSED PLASTER BOARD LED 3CCT

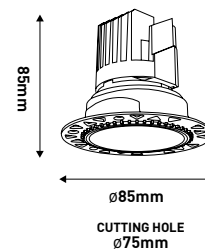

Ø85x85mm

Volt: **220-240V 50/60Hz** • Output: **33-40V DC** • LED Type: **COB**

3CCT: **3000K/4500K/6500K**

Γωνία Δέσμης Φωτός / Beam Angle: **60°**

Ενεργειακή Κλάση / Energy Class: **F**

Start Time: **0,5sec** • PF > **0,50** • CRI > **80**

Θερμοκρασία Λειτουργίας / Operating Temperature: **-10/+60°C**

Υλικό / Material: **Αλουμίνιο & Πλαστικό / Aluminium & Plastic**

Σύνδεση / Connection: **Καλώδιο / Wire**

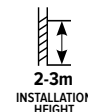

CODE	BARCODE	WATT	KELVIN	LUMEN/WATT	COLOR	PACKING	MOQ	PRICE (€)
145-65100	5207227282812	9	3CCT	100	WHITE	1/20	1	23,25

ΧΩΝΕΥΤΑ LED RECESSED LED



12V AC/DC

Ø30x25mm

Volt: **12V AC/DC** • LED Type: **COB**

Γωνία Δέσμης Φωτός / Beam Angle: **36°**

Ενεργειακή Κλάση / Energy Class: **F**

Start Time: **0,5sec** • CRI > **80**

Θερμοκρασία Λειτουργίας / Operating Temperature: **-10/+60°C**

Υλικό / Material: **Αλουμίνιο & Πλαστικό / Aluminium & Plastic**

Σύνδεση / Connection: **Καλώδιο / Wire**

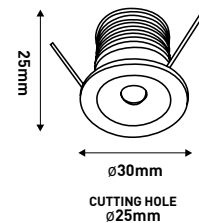
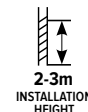

CODE	BARCODE	WATT	KELVIN	LUMEN/WATT	COLOR	PACKING	MOQ	PRICE (€)
145-68910	5207227282683	1	6500	80	WHITE	1/90	1	4,85
145-68911	5207227282690	1	4000	80	WHITE	1/90	1	4,85
145-68912	5207227282706	1	3000	80	WHITE	1/90	1	4,85

ΧΩΝΕΥΤΑ LED 3CCT RECESSED LED 3CCT



Volt: **220-240V 50/60Hz** • LED Type: **SMD2835**

3CCT: **3000K/4000K/6500K**

Γωνία Δέσμης Φωτός / Beam Angle: **120°**

Ενεργειακή Κλάση / Energy Class: **E**

Start Time: **0,5sec** • PF > **0,50** • CRI > **80** • IK03

Θερμοκρασία Λειτουργίας / Operating Temperature: **-20/+45°C**

Υλικό / Material: **Πλαστικό / Plastic**

Σύνδεση / Connection: **Κλέμμα / Terminal Block**

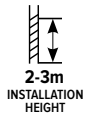

CODE	BARCODE	WATT	KELVIN	DIMENSIONS	CUTTING HOLE	WEIGHT	PACKING	MOQ	PRICE (€)
145-68100	5207227302404	4,9	3CCT	Ø90x50mm	Ø70-80mm	0.075kg	1/40	1	5,25
145-68101	5207227302374	9	3CCT	Ø130x50mm	Ø105-115mm	0.122kg	1/40	1	5,95
145-68102	5207227302398	12	3CCT	Ø145x50mm	Ø120-130mm	0.138kg	1/40	1	7,90
145-68103	5207227302381	18	3CCT	Ø175x50mm	Ø145-155mm	0.175kg	1/40	1	9,80
145-68104	5207227302367	24	3CCT	Ø225x50mm	Ø195-210mm	0.255kg	1/40	1	12,45



ΧΩΝΕΥΤΑ LED SLIM RECESSED LED SLIM



Ø85x10.5mm

Volt: **85-265V 50/60Hz**

Γωνία Δέσμης Φωτός / Beam Angle: **120°**

Ενεργειακή Κλάση / Energy Class: **F**

LED Type: **SMD2835**

Start Time: **0,5sec** • PF > **0,50** • CRI > **80**

Θερμοκρασία Λειτουργίας / Operating Temperature: **-10/+60°C**

Υλικό / Material: **Αλουμίνιο & Πλαστικό / Aluminium & Plastic**

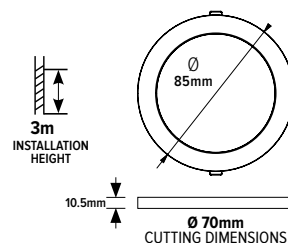

CODE	BARCODE	WATT	KELVIN	LUMEN/WATT	COLOR	PACKING	MOQ	PRICE (€)
145-68600	5206139014931	3	6500	90	WHITE	1/10/60	1	3,48
145-68601	5206139037190	3	4000	90	WHITE	1/10/60	1	3,48
145-68602	5207227020544	3	3000	90	WHITE	1/10/60	1	3,48
145-68620	5207227268779	3	6500	90	BLACK	1/10/60	1	3,48
145-68621	5207227268786	3	4000	90	BLACK	1/10/60	1	3,48
145-68622	5207227268793	3	3000	90	BLACK	1/10/60	1	3,48
145-68604	5206139037206	3	4000	90	SATIN	1/10/60	1	4,26

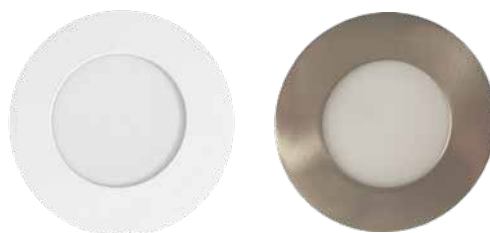

Ø85x10.5mm

Volt: **85-265V 50/60Hz**

Γωνία Δέσμης Φωτός / Beam Angle: **120°**

Ενεργειακή Κλάση / Energy Class: **F**

LED Type: **SMD2835**

Start Time: **0,5sec** • PF > **0,50** • CRI > **80**

Θερμοκρασία Λειτουργίας / Operating Temperature: **-10/+60°C**

Υλικό / Material: **Αλουμίνιο & Πλαστικό / Aluminium & Plastic**

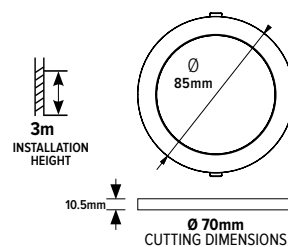

CODE	BARCODE	WATT	KELVIN	LUMEN/WATT	COLOR	PACKING	MOQ	PRICE (€)
145-68630	5207227245176	5	6500	90	WHITE	1/10/60	1	3,58
145-68631	5207227245206	5	4000	90	WHITE	1/10/60	1	3,58
145-68632	5207227245237	5	3000	90	WHITE	1/10/60	1	3,58
145-68633	5207227245268	5	6500	90	SATIN	1/10/60	1	5,56
145-68634	5207227245299	5	4000	90	SATIN	1/10/60	1	5,56
145-68635	5207227245329	5	3000	90	SATIN	1/10/60	1	5,56

ΧΩΝΕΥΤΑ LED SLIM RECESSED LED SLIM



Ø120x10.5mm

Volt: **85-265V 50/60Hz** • LED Type: **SMD2835**

Γωνία Δέσμης Φωτός / Beam Angle: **120°**

Ενεργειακή Κλάση / Energy Class: **F**

Start Time: **0,5sec** • PF > **0,50** • CRI > **80**

Υλικό / Material:

Αλουμίνιο & Πλαστικό / Aluminium & Plastic

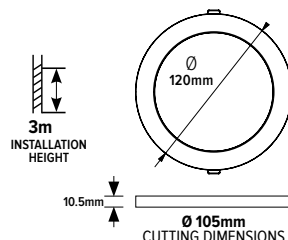

CODE	BARCODE	WATT	KELVIN	LUMEN/WATT	COLOR	PACKING	MOQ	PRICE (€)
145-68606	5207227020568	6	6500	90	WHITE	1/10/40	1	4,35
145-68607	5207227124037	6	4000	90	WHITE	1/40	1	4,35
145-68608	5207227020582	6	3000	90	WHITE	1/40	1	4,35



Ø145x10.5mm

Volt: **85-265V 50/60Hz** • LED Type: **SMD2835**

Γωνία Δέσμης Φωτός / Beam Angle: **120°**

Ενεργειακή Κλάση / Energy Class: **F**

Start Time: **0,5sec** • PF > **0,50** • CRI > **80**

Υλικό / Material:

Αλουμίνιο & Πλαστικό / Aluminium & Plastic

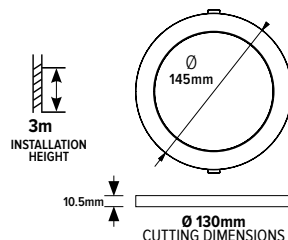

CODE	BARCODE	WATT	KELVIN	LUMEN/WATT	COLOR	PACKING	MOQ	PRICE (€)
145-68609	5207227020605	9	6500	90	WHITE	1/20	1	5,60
145-68610	5207227124051	9	4000	90	WHITE	1/20	1	5,60
145-68611	5207227020629	9	3000	90	WHITE	1/20	1	5,60



Ø170x10.5mm

Volt: **85-265V 50/60Hz** • LED Type: **SMD2835**

Γωνία Δέσμης Φωτός / Beam Angle: **120°**

Ενεργειακή Κλάση / Energy Class: **F**

Start Time: **0,5sec** • PF > **0,50** • CRI > **80**

Υλικό / Material:

Αλουμίνιο & Πλαστικό / Aluminium & Plastic

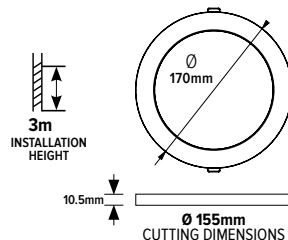
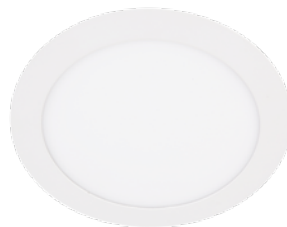

CODE	BARCODE	WATT	KELVIN	LUMEN/WATT	COLOR	PACKING	MOQ	PRICE (€)
145-68612	5207227020643	12	6500	90	WHITE	1/20	1	5,75
145-68613	5207227124075	12	4000	90	WHITE	1/20	1	5,75
145-68614	5207227020667	12	3000	90	WHITE	1/20	1	5,75

ΧΩΝΕΥΤΑ LED SLIM RECESSED LED SLIM



Ø225x10.5mm

Volt: **85-265V 50/60Hz**

Γωνία Δέσμης Φωτός / Beam Angle: **120°**

Ενεργειακή Κλάση / Energy Class: **F**

LED Type: **SMD2835**

Start Time: **0,5sec** • PF > **0,50** • CRI > **80**

Θερμοκρασία Λειτουργίας / Operating Temperature: **-10/+60°C**

Υλικό / Material: **Αλουμίνιο & Πλαστικό / Aluminium & Plastic**

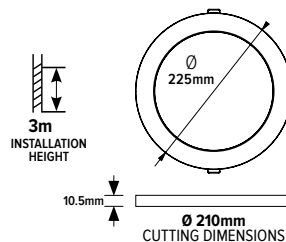

CODE	BARCODE	WATT	KELVIN	LUMEN/WATT	COLOR	PACKING	MOQ	PRICE (€)
145-68000	5206139037824	20	6500	90	SATIN	1/20	1	9,25
145-68001	5206139037213	20	4000	90	SATIN	1/20	1	9,25
145-68010	5206139021427	20	6500	90	WHITE	1/20	1	7,65
145-68011	5206139021434	20	4000	90	WHITE	1/20	1	7,65
145-68012	5206139021441	20	3000	90	WHITE	1/20	1	7,65
145-68015	5207227268595	20	6500	90	BLACK	1/20	1	7,65
145-68014	5207227268571	20	4000	90	BLACK	1/20	1	7,65
145-68013	5207227268557	20	3000	90	BLACK	1/20	1	7,65

ΧΩΝΕΥΤΑ LED SLIM RECESSED LED SLIM

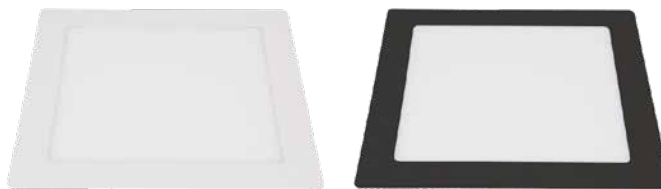

225x225x10.5mm

Volt: **85-265V 50/60Hz**

Γωνία Δέσμης Φωτός / Beam Angle: **120°**

Ενεργειακή Κλάση / Energy Class: **F**

LED Type: **SMD2835**

Start Time: **0,5sec** • PF > **0,50** • CRI > **80**

Θερμοκρασία Λειτουργίας / Operating Temperature: **-10/+60°C**

Υλικό / Material: **Αλουμίνιο & Πλαστικό / Aluminium & Plastic**

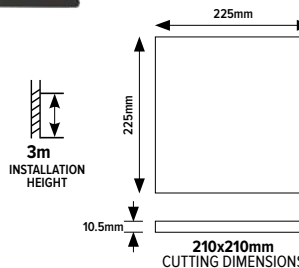

CODE	BARCODE	WATT	KELVIN	LUMEN/WATT	COLOR	PACKING	MOQ	PRICE (€)
145-68020	5206139026224	20	6500	90	WHITE	1/20	1	7,65
145-68021	5206139098900	20	4000	90	WHITE	1/20	1	7,65
145-68022	5207227124099	20	3000	90	WHITE	1/20	1	7,65
145-68023	5207227268601	20	6500	90	BLACK	1/20	1	7,65
145-68024	5207227268625	20	4000	90	BLACK	1/20	1	7,65
145-68025	5207227268649	20	3000	90	BLACK	1/20	1	7,65



ΧΩΝΕΥΤΑ LED SLIM RECESSED LED SLIM



5
YEARS

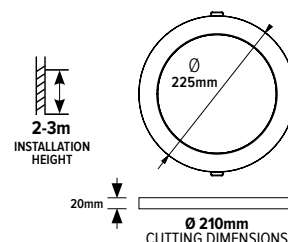

Ø225x20mm

Volt: **85-265V 50/60Hz**

Γωνία Δέσμης Φωτός / Beam Angle: **120°**

Ενεργειακή Κλάση / Energy Class: **F**

LED Type: **SMD2835**

Start Time: **0,5sec** • PF > **0,50** • CRI > **80**

Υλικό / Material:

Αλουμίνιο & Πλαστικό / Aluminium & Plastic

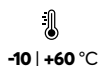

CODE	BARCODE	WATT	KELVIN	LUMEN/WATT	COLOR	PACKING	MOQ	PRICE (€)
145-68450	5207227282669	20	6500	100	WHITE	1/20	1	19,85
145-68451	5207227282645	20	4000	100	WHITE	1/20	1	19,85
145-68452	5207227282652	20	5000	100	WHITE	1/20	1	19,85



3
YEARS

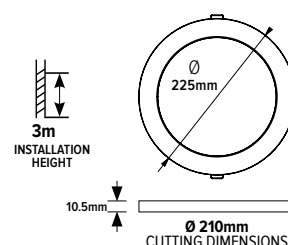
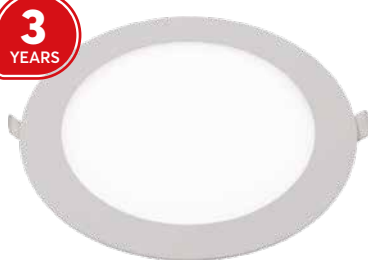

Ø225x10.5mm

Volt: **85-265V 50/60Hz** • LED Type: **SMD2835**

Γωνία Δέσμης Φωτός / Beam Angle: **120°**

Ενεργειακή Κλάση / Energy Class: **F**

Start Time: **0,5sec** • PF > **0,50** • CRI > **80**

Υλικό / Material:

Αλουμίνιο & Πλαστικό / Aluminium & Plastic



CODE	BARCODE	WATT	KELVIN	LUMEN/WATT	COLOR	PACKING	MOQ	PRICE (€)
145-68410	5207227033599	20	6500	105	SATIN	1/20	1	14,65
145-68411	5207227033612	20	4000	103	SATIN	1/20	1	14,65
145-68412	5207227033636	20	3000	95	SATIN	1/20	1	14,65



3
YEARS

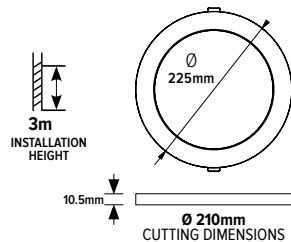

Ø225x10.5mm

Volt: **85-265V 50/60Hz**

Γωνία Δέσμης Φωτός / Beam Angle: **120°**

Ενεργειακή Κλάση / Energy Class: **F**

LED Type: **SMD2835**

Start Time: **0,5sec** • PF > **0,50** • CRI > **80**

Υλικό / Material:

Αλουμίνιο & Πλαστικό / Aluminium & Plastic



CODE	BARCODE	WATT	KELVIN	LUMEN/WATT	COLOR	PACKING	MOQ	PRICE (€)
145-68400	5207227033551	20	6500	105	WHITE	1/20	1	11,65
145-68401	5207227033568	20	4000	103	WHITE	1/20	1	11,65
145-68402	5207227033575	20	3000	95	WHITE	1/20	1	11,65

ΧΩΝΕΥΤΑ LED SLIM ME ΡΥΘΜΙΖΟΜΕΝΗ ΕΓΚΟΠΗ RECESSED LED SLIM WITH ADJUSTABLE CUT



Ø120x10.5mm

Volt: **85-265V 50/60Hz** • LED Type: **SMD2835**

Γωνία Δέσμης Φωτός / Beam Angle: **120°**

Ενεργειακή Κλάση / Energy Class: **F**

Start Time: **0,5sec** • PF > **0,50** • CRI > **80**

Θερμοκρασία Λειτουργίας / Operating Temperature: **-10/+60°C**

Υλικό / Material: **Αλουμίνιο & Πλαστικό / Aluminium & Plastic**

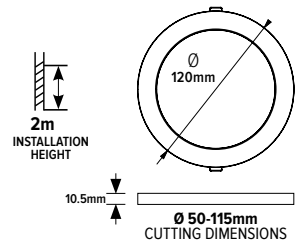

CODE	BARCODE	WATT	KELVIN	LUMEN/WATT	COLOR	PACKING	MOQ	PRICE (€)
145-68423	5207227071911	8	6500	105	WHITE	1/40	1	7,25
145-68424	5207227071928	8	4000	103	WHITE	1/40	1	7,25
145-68425	5207227071935	8	3000	95	WHITE	1/40	1	7,25



Ø225x12mm

Volt: **85-265V 50/60Hz** • LED Type: **SMD2835**

Γωνία Δέσμης Φωτός / Beam Angle: **120°**

Ενεργειακή Κλάση / Energy Class: **F**

Start Time: **0,5sec** • PF > **0,50** • CRI > **80**

Θερμοκρασία Λειτουργίας / Operating Temperature: **-10/+60°C**

Υλικό / Material: **Αλουμίνιο & Πλαστικό / Aluminium & Plastic**

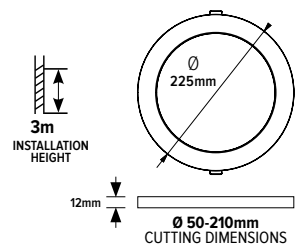

CODE	BARCODE	WATT	KELVIN	LUMEN/WATT	COLOR	PACKING	MOQ	PRICE (€)
145-68420	5207227033650	20	6500	105	WHITE	1/20	1	12,45
145-68421	5207227033674	20	4000	103	WHITE	1/20	1	12,45
145-68422	5207227033698	20	3000	95	WHITE	1/20	1	12,45

ΧΩΝΕΥΤΑ LED SLIM RECESSED LED SLIM



Ø225x45mm

Volt: **85-265V 50/60Hz**

Γωνία Δέσμης Φωτός / Beam Angle: **120°**

Ενεργειακή Κλάση / Energy Class: **F**

LED Type: **SMD2835**

Start Time: **2sec** • PF > **0,90** • CRI > **80**

Υλικό / Material:

Αλουμίνιο & Πλαστικό / Aluminium & Plastic

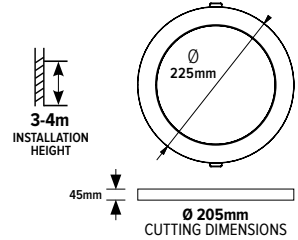

CODE	BARCODE	WATT	KELVIN	LUMEN/WATT	COLOR	PACKING	MOQ	PRICE (€)
145-68430	5207227120961	25	6500	105	WHITE	1/20	1	16,85
145-68431	5207227120985	25	4000	103	WHITE	1/20	1	16,85
145-68432	5207227120992	25	3000	95	WHITE	1/20	1	16,85



Ø225x45mm

Volt: **85-265V 50/60Hz**

Γωνία Δέσμης Φωτός / Beam Angle: **120°**

Ενεργειακή Κλάση / Energy Class: **F**

LED Type: **SMD2835**

Start Time: **2sec** • PF > **0,90** • CRI > **80**

Υλικό / Material:

Αλουμίνιο & Πλαστικό / Aluminium & Plastic

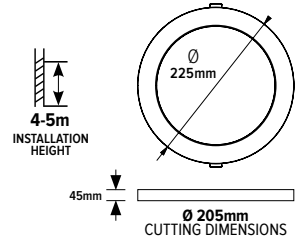

CODE	BARCODE	WATT	KELVIN	LUMEN/WATT	COLOR	PACKING	MOQ	PRICE (€)
145-68433	5207227121005	30	6500	105	WHITE	1/20	1	18,25
145-68434	5207227121012	30	4000	103	WHITE	1/20	1	18,25
145-68435	5207227121029	30	3000	95	WHITE	1/20	1	18,25



Ø225x45mm

Volt: **85-265V 50/60Hz**

Γωνία Δέσμης Φωτός / Beam Angle: **120°**

Ενεργειακή Κλάση / Energy Class: **F**

LED Type: **SMD2835**

Start Time: **2sec** • PF > **0,90** • CRI > **80**

Υλικό / Material:

Αλουμίνιο & Πλαστικό / Aluminium & Plastic

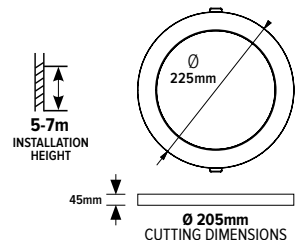

CODE	BARCODE	WATT	KELVIN	LUMEN/WATT	COLOR	PACKING	MOQ	PRICE (€)
145-68436	5207227121036	40	6500	105	WHITE	1/20	1	19,80
145-68437	5207227121043	40	4000	103	WHITE	1/20	1	19,80
145-68438	5207227121050	40	3000	95	WHITE	1/20	1	19,80

ΧΩΝΕΥΤΑ LED SMD ΠΑΡΑΛΛΗΛΟΓΡΑΜΜΟ RECESSED LED SMD PARALLELOGRAM

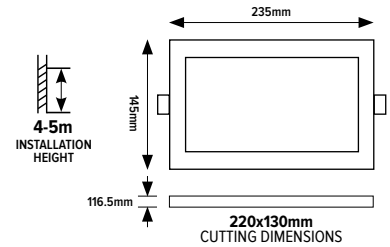

220x132x116.5cm

Volt: **220-240V 50/60Hz** • LED Type: **SMD5730**

Γωνία Δέσμης Φωτός / Beam Angle: **120°**

Ενεργειακή Κλάση / Energy Class: **F**

Start Time: **0,5sec** • PF > **0.95** • CRI > **80**

Υλικό / Material:

Αλουμίνιο & Πλαστικό / Aluminium & Plastic



CODE	BARCODE	WATT	KELVIN	LUMEN/WATT	COLOR	PACKING	MOQ	PRICE (€)
145-68252	5207227205743	35	4000	90	WHITE	1/8	1	45,85

ΧΩΝΕΥΤΑ LED COB RECESSED LED COB

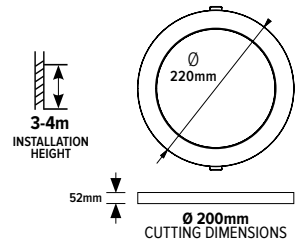

Ø220x52mm

Volt: **170-265V 50/60Hz** • LED Type: **COB7660**

Γωνία Δέσμης Φωτός / Beam Angle: **120°**

Ενεργειακή Κλάση / Energy Class: **F**

Start Time: **3sec** • PF > **0,50** • CRI > **80**

Υλικό / Material:

Αλουμίνιο & Πλαστικό / Aluminium & Plastic



CODE	BARCODE	WATT	KELVIN	LUMEN/WATT	COLOR	PACKING	MOQ	PRICE (€)
145-68201	5206139025081	30	6500	90	WHITE	1/20	1	15,85
145-68202	5206139098665	30	4000	90	WHITE	1/20	1	15,85

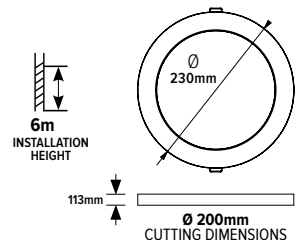

Ø230x113mm

Volt: **85-265V 50/60Hz** • LED Type: **COB1428**

Γωνία Δέσμης Φωτός / Beam Angle: **50°**

Ενεργειακή Κλάση / Energy Class: **F**

Start Time: **3sec** • PF > **0,90** • CRI > **80**

Υλικό / Material:

Αλουμίνιο & Πλαστικό / Aluminium & Plastic



CODE	BARCODE	WATT	KELVIN	LUMEN/WATT	COLOR	PACKING	MOQ	PRICE (€)
145-68205	5207227008375	55	6500	90	WHITE	1/10	1	59,60
145-68206	5207227002502	55	4000	90	WHITE	1/10	1	59,60

ΤΡΟΦΟΔΟΤΙΚΑ DIMMING ΓΙΑ SLIM LED PANEL DIMMING DRIVERS FOR SLIM LED PANEL



Volt: **198-264V 50/60Hz**
 Output: **6-52V DC • PF > 0.90**
 Υλικό / Material: **Πλαστικό / Plastic**
 Σύνδεση / Connection: **Καλώδιο / Wire**



-20 | +50 °C
 CLASS II
 PUSH DIMMING
 0,15kg
 100.000h
 ON OFF >100.000
 IP20
 5 YEARS WARRANTY

CODE	BARCODE	WATT	AMPERAGE	DIMENSIONS	COLOR	PACKING	MOQ	PRICE (€)
145-68080	5207227279324	7-12	350mA	97x43x30mm	WHITE	1/100	1	37,65



Volt: **198-264V 50/60Hz**
 Output: **6-52V DC • PF > 0.90**
 Υλικό / Material: **Πλαστικό / Plastic**
 Σύνδεση / Connection: **Καλώδιο / Wire**



-20 | +50 °C
 CLASS II
 PUSH DIMMING
 0,15kg
 100.000h
 ON OFF >100.000
 IP20
 5 YEARS WARRANTY

CODE	BARCODE	WATT	AMPERAGE	DIMENSIONS	COLOR	PACKING	MOQ	PRICE (€)
145-68081	5207227279348	15-24	600mA	97x43x30mm	WHITE	1/100	1	39,85



Volt: **100-240V 50/60Hz**
 Output: **21-52V DC • PF > 0.50**
 Υλικό / Material: **Πλαστικό / Plastic**
 Σύνδεση / Connection: **Καλώδιο / Wire**



-20 | +40 °C
 CLASS II
 DIMMABLE
 0,63kg
 20.000h
 ON OFF 15.000
 IP20
 2 YEARS WARRANTY

CODE	BARCODE	WATT	DIMMING	DIMENSIONS	COLOR	PACKING	MOQ	PRICE (€)
145-68090	5207227191992	7-15	Ohm Dimmer	80x35x20mm	WHITE	1/100	1	8,85



Volt: **100-240V 50/60Hz**
 Output: **33-75V DC • PF > 0.50**
 Υλικό / Material: **Πλαστικό / Plastic**
 Σύνδεση / Connection: **Καλώδιο / Wire**



-20 | +40 °C
 CLASS II
 DIMMABLE
 0,63kg
 20.000h
 ON OFF 15.000
 IP20
 2 YEARS WARRANTY

CODE	BARCODE	WATT	DIMMING	DIMENSIONS	COLOR	PACKING	MOQ	PRICE (€)
145-68091	5207227192005	15-24	Ohm Dimmer	80x35x20mm	WHITE	1/100	1	10,80

ΤΡΟΦΟΔΟΤΙΚΑ ΓΙΑ SLIM LED PANEL DRIVERS FOR SLIM LED PANEL



Volt: **85-265V 50/60Hz** • Output: **38-64V DC** • PF >0.50
 Θερμοκρασία Λειτουργίας / Operating Temperature: **-10/+60°C**
 Υλικό / Material: **Πλαστικό / Plastic**
 Σύνδεση / Connection: **Καλώδιο / Wire**



CLASS I
 NON DIMMABLE
 0,080kg
 50.000h
 ON OFF 15.000
 IP20
 3 YEARS WARRANTY

CODE	BARCODE	WATT	DIMENSIONS	COLOR	PACKING	MOQ	PRICE (€)
145-68096	5207227035494	20	900x450x260mm	WHITE	1/200	1	4,35



Volt: **85-265V 50/60Hz** • Output: **60-72V DC** • PF >0.50
 Θερμοκρασία Λειτουργίας / Operating Temperature: **-10/+60°C**
 Υλικό / Material: **Πλαστικό / Plastic**
 Σύνδεση / Connection: **Καλώδιο / Wire**



CLASS I
 NON DIMMABLE
 0,080kg
 50.000h
 ON OFF 15.000
 IP20
 3 YEARS WARRANTY

CODE	BARCODE	WATT	DIMENSIONS	COLOR	PACKING	MOQ	PRICE (€)
145-68098	5207227110719	24	1100x420x280mm	WHITE	1/10/100	1	5,55



Volt: **85-265V 50/60Hz** • Output: **38-64V DC** • PF >0.50
 Θερμοκρασία Λειτουργίας / Operating Temperature: **-10/+60°C**
 Υλικό / Material: **Πλαστικό / Plastic**
 Σύνδεση / Connection: **Καλώδιο / Wire**



CLASS I
 NON DIMMABLE
 0,080kg
 30.000h
 ON OFF 15.000
 IP20
 2 YEARS WARRANTY

CODE	BARCODE	WATT	DIMENSIONS	COLOR	PACKING	MOQ	PRICE (€)
145-68097	5207227039409	20	80x35x20mm	WHITE	1/200	1	3,65

ΤΡΟΦΟΔΟΤΙΚΑ ΓΙΑ SLIM LED PANEL DRIVERS FOR SLIM LED PANEL



Volt: **85-265V 50/60Hz**

Θερμοκρασία Λειτουργίας / Operating Temperature: **-20/+40°C**

Υλικό / Material: **Πλαστικό / Plastic**

Σύνδεση / Connection: **Καλώδιο / Wire**



CODE	BARCODE	WATT	OUTPUT	DIMENSIONS	PF	PACKING	MOQ	PRICE (€)
145-68093	5207227279270	20	60-72V DC	95x35x20mm	>0.5	1/10/100	1	4,25
145-68092	5207227279294	30	33-40V DC	95x35x20mm	>0.5	1/10/100	1	5,15



Volt: **85-265V 50/60Hz • PF<0.50**

Θερμοκρασία Λειτουργίας / Operating Temperature: **-20/+40°C**

Υλικό / Material: **Πλαστικό / Plastic**

Σύνδεση / Connection: **Καλώδιο / Wire**



CODE	BARCODE	WATT	OUTPUT	DIMENSIONS	WEIGHT	PACKING	MOQ	PRICE (€)
145-68490	5207227268809	25	24-42V DC	95x35x20mm	0,20kg	1/10/100	1	6,85
145-68491	5207227207471	30	30-40V DC	95x35x20mm	0,25kg	1/10/100	1	6,85
145-68492	5207227268816	40	30-38V DC	95x35x20mm	0,30kg	1/10/100	1	6,85

ΑΞΕΣΟΥΑΡ ΓΙΑ LED PANEL ACCESSORIES FOR LED PANEL

ΣΤΕΦΑΝΙ ΥΠΟΣΤΗΡΙΞΗ PANEL Ø240mm

FRAME ADAPTOR PANEL Ø240mm

Ø240mm

Υλικό / Material: **Αλουμίνιο / Aluminium**

CODE	BARCODE	COLOR	PACKING	MOQ	PRICE (€)
145-68099	5207227072178	SILVER	1/1	1	5,15



ΗΧΕΙΑ ΧΩΝΕΥΤΑ CEILING SPEAKER

Volt: **100V**

Θερμοκρασία Λειτουργίας / Operating Temperature: **-10/+60°C**

Υλικό / Material: **ABS**

Με Μετασχηματιστή / With Transformer



1,110kg



IP20



2 YEARS WARRANTY

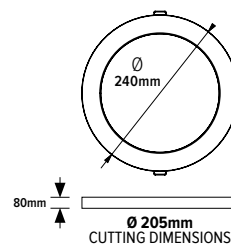

CODE	BARCODE	WATT	Frequency (Hz)	SOUND dB	COLOR	PACKING	MOQ	PRICE (€)
147-68973	5207227032189	10	90-18khz	91	WHITE	1/20	1	36,25

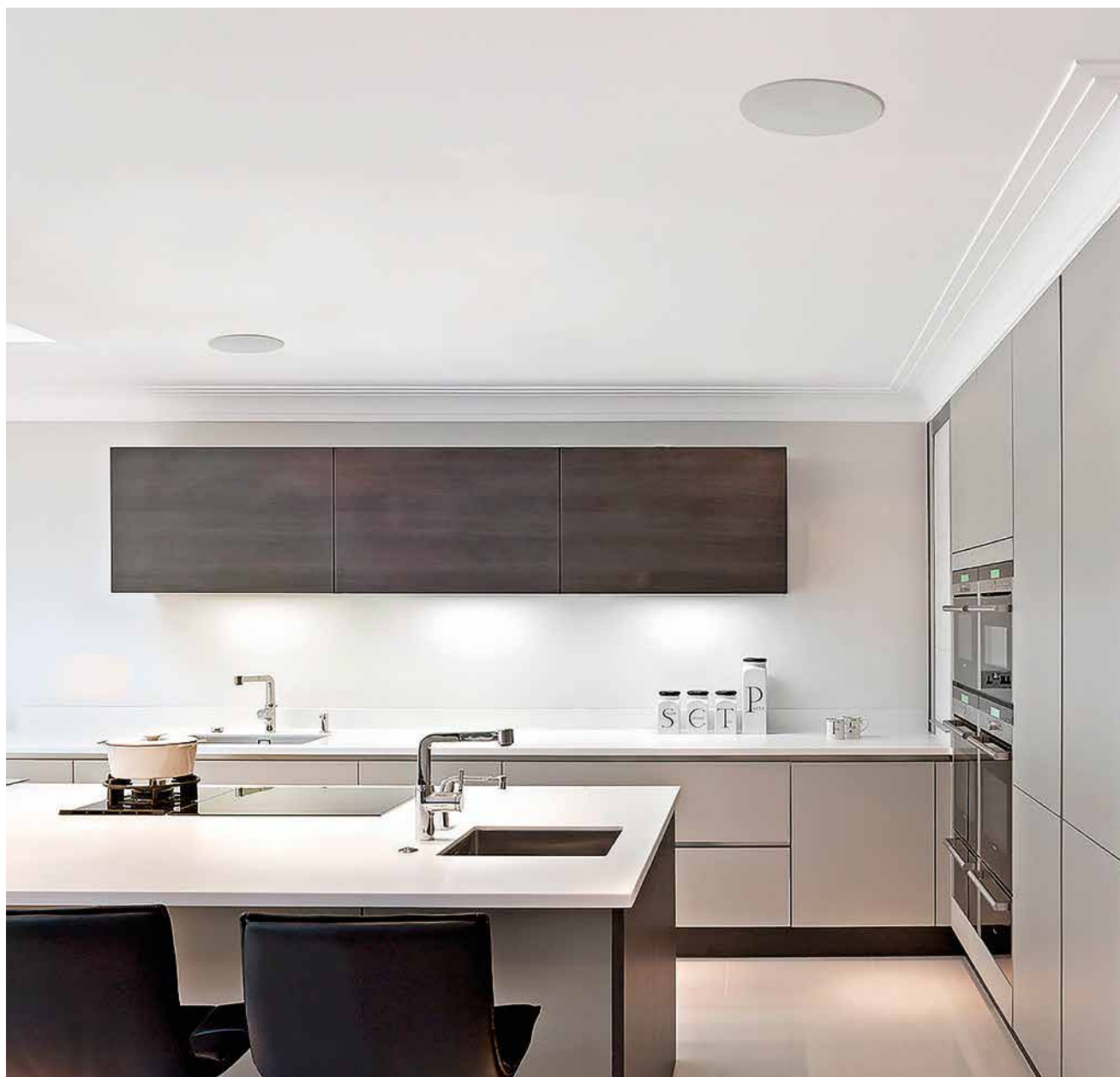

Φωτιστικά LED Εξωτερικά

LED Fixtures
Surface Mounted



ΕΞΩΤΕΡΙΚΑ LED SLIM SURFACE MOUNTED LED SLIM



Ø120x32mm

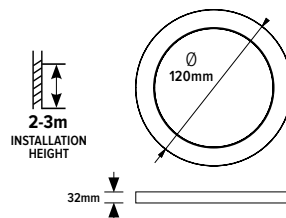

Volt: **85-265V 50/60Hz** • LED Type: **SMD2835**

Γωνία Δέσμης Φωτός / Beam Angle: **120°**

Ενεργειακή Κλάση / Energy Class: **F**

Start Time: **0,5sec** • PF > **0,90** • CRI > **80**

Υλικό / Material: **Αλουμίνιο & Πλαστικό / Aluminium & Plastic**



CODE	BARCODE	WATT	KELVIN	LUMEN/WATT	COLOR	PACKING	MOQ	PRICE (€)
145-68500	5207227069468	6	6500	90	WHITE	1/40	1	5,45
145-68501	5207227069482	6	4000	90	WHITE	1/40	1	5,45
145-68502	5207227069505	6	3000	90	WHITE	1/40	1	5,45



Ø170x32mm

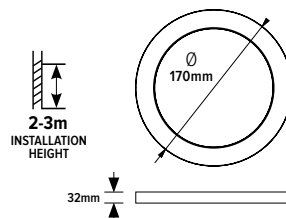

Volt: **85-265V 50/60Hz** • LED Type: **SMD2835**

Γωνία Δέσμης Φωτός / Beam Angle: **120°**

Ενεργειακή Κλάση / Energy Class: **F**

Start Time: **0,5sec** • PF > **0,90** • CRI > **80**

Υλικό / Material: **Αλουμίνιο & Πλαστικό / Aluminium & Plastic**



CODE	BARCODE	WATT	KELVIN	LUMEN/WATT	COLOR	PACKING	MOQ	PRICE (€)
145-68506	5207227069529	12	6500	90	WHITE	1/20	1	8,15
145-68507	5207227069543	12	4000	90	WHITE	1/20	1	8,15
145-68508	5207227069567	12	3000	90	WHITE	1/20	1	8,15



Ø225x32mm

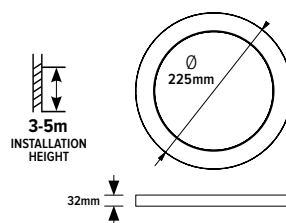

Volt: **85-265V 50/60Hz** • LED Type: **SMD2835**

Γωνία Δέσμης Φωτός / Beam Angle: **120°**

Ενεργειακή Κλάση / Energy Class: **F**

Start Time: **0,5sec** • PF > **0,90** • CRI > **80**

Υλικό / Material: **Αλουμίνιο & Πλαστικό / Aluminium & Plastic**



CODE	BARCODE	WATT	KELVIN	LUMEN/WATT	COLOR	PACKING	MOQ	PRICE (€)
145-68510	5207227124105	20	6500	90	WHITE	1/20	1	10,35
145-68511	5207227124112	20	4000	90	WHITE	1/20	1	10,35
145-68512	5207227124136	20	3000	90	WHITE	1/20	1	10,35
145-68546	5207227268656	20	6500	90	BLACK	1/20	1	10,35
145-68547	5207227268663	20	4000	90	BLACK	1/20	1	10,35
145-68548	5207227268670	20	3000	90	BLACK	1/20	1	10,35

ΕΞΩΤΕΡΙΚΑ LED SLIM SURFACE MOUNTED LED SLIM



Ø225x32mm

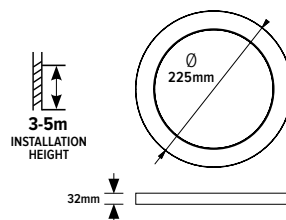

Volt: **85-265V 50/60Hz** • LED Type: **SMD2835**

Γωνία Δέσμης Φωτός / Beam Angle: **120°**

Ενεργειακή Κλάση / Energy Class: **F**

Start Time: **0,5sec** • PF > **0,90** • CRI > **80**

Υλικό / Material: **Αλουμίνιο & Πλαστικό / Aluminium & Plastic**



CODE	BARCODE	WATT	KELVIN	LUMEN/WATT	COLOR	PACKING	MOQ	PRICE (€)
145-68513	5207227117640	24	6500	90	WHITE	1/20	1	11,75
145-68514	5207227117657	24	4000	90	WHITE	1/20	1	11,75
145-68515	5207227117664	24	3000	90	WHITE	1/20	1	11,75



Ø300x32mm

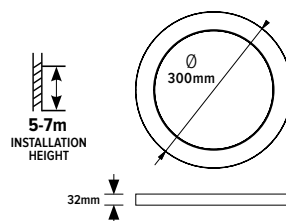

Volt: **85-265V 50/60Hz** • LED Type: **SMD2835**

Γωνία Δέσμης Φωτός / Beam Angle: **120°**

Ενεργειακή Κλάση / Energy Class: **F**

Start Time: **0,5sec** • PF > **0,90** • CRI > **80**

Υλικό / Material: **Αλουμίνιο & Πλαστικό / Aluminium & Plastic**



CODE	BARCODE	WATT	KELVIN	LUMEN/WATT	COLOR	PACKING	MOQ	PRICE (€)
145-68516	5207227117671	30	6500	90	WHITE	1/10	1	14,85
145-68517	5207227117688	30	4000	90	WHITE	1/10	1	14,85
145-68518	5207227117695	30	3000	90	WHITE	1/10	1	14,85
145-68549	5207227268687	30	6500	90	BLACK	1/10	1	14,85
145-68550	5207227268694	30	4000	90	BLACK	1/10	1	14,85
145-68551	5207227268700	30	3000	90	BLACK	1/10	1	14,85



143x123x40mm

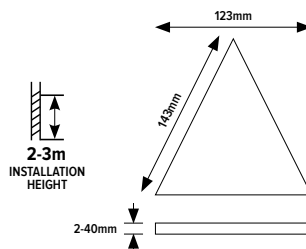

Volt: **220-240V 50/60Hz** • LED Type: **SMD2835**

Γωνία Δέσμης Φωτός / Beam Angle: **106°**

Ενεργειακή Κλάση / Energy Class: **G**

Start Time: **0,5sec** • PF > **0,50** • CRI > **80**

Υλικό / Material: **Πλαστικό / Plastic**



CODE	BARCODE	WATT	KELVIN	LUMEN/WATT	COLOR	PACKING	MOQ	PRICE (€)
145-68671	5207227019289	2	4200	55	WHITE	1/100	1	3,95
145-68672	5207227019302	2	3000	55	WHITE	1/100	1	3,95

ΕΞΩΤΕΡΙΚΑ LED SLIM SURFACE MOUNTED LED SLIM



120x120x32mm

Volt: **85-265V 50/60Hz** • LED Type: **SMD2835**

Γωνία Δέσμης Φωτός / Beam Angle: **120°**

Ενεργειακή Κλάση / Energy Class: **F**

Start Time: **0,5sec** • PF > **0,90** • CRI > **80**

Υλικό / Material: **Αλουμίνιο & Πλαστικό / Aluminium & Plastic**

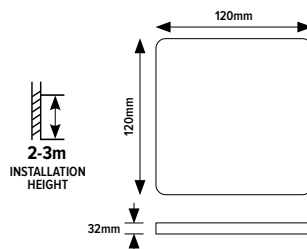
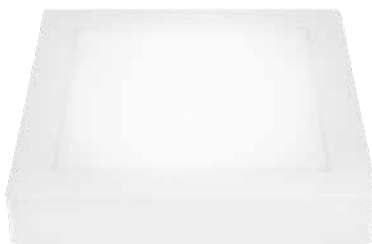

CODE	BARCODE	WATT	KELVIN	LUMEN/WATT	COLOR	PACKING	MOQ	PRICE (€)
145-68520	5207227069581	6	6500	90	WHITE	1/20	1	5,45
145-68521	5207227069604	6	4000	90	WHITE	1/20	1	5,45
145-68522	5207227069628	6	3000	90	WHITE	1/20	1	5,45



170x170x32mm

Volt: **85-265V 50/60Hz** • LED Type: **SMD2835**

Γωνία Δέσμης Φωτός / Beam Angle: **120°**

Ενεργειακή Κλάση / Energy Class: **F**

Start Time: **0,5sec** • PF > **0,90** • CRI > **80**

Υλικό / Material: **Αλουμίνιο & Πλαστικό / Aluminium & Plastic**

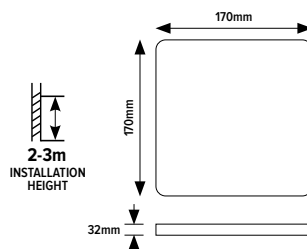
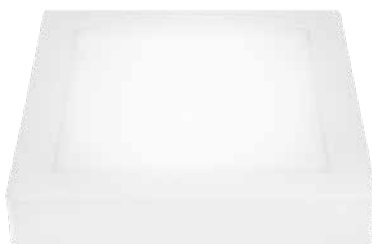

CODE	BARCODE	WATT	KELVIN	LUMEN/WATT	COLOR	PACKING	MOQ	PRICE (€)
145-68526	5207227069642	12	6500	90	WHITE	1/20	1	8,15
145-68527	5207227069666	12	4000	90	WHITE	1/20	1	8,15
145-68528	5207227069680	12	3000	90	WHITE	1/20	1	8,15



225x225x32mm

Volt: **85-265V 50/60Hz** • LED Type: **SMD2835**

Γωνία Δέσμης Φωτός / Beam Angle: **120°**

Ενεργειακή Κλάση / Energy Class: **F**

Start Time: **0,5sec** • PF > **0,90** • CRI > **80**

Υλικό / Material: **Αλουμίνιο & Πλαστικό / Aluminium & Plastic**

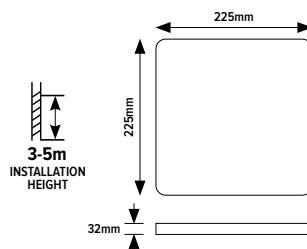
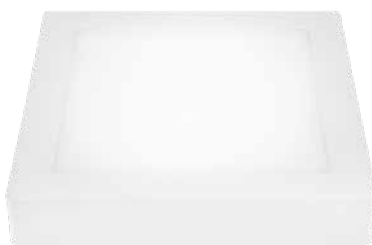

CODE	BARCODE	WATT	KELVIN	LUMEN/WATT	COLOR	PACKING	MOQ	PRICE (€)
145-68530	5207227124143	20	6500	90	WHITE	1/20	1	10,35
145-68531	5207227124150	20	4000	90	WHITE	1/20	1	10,35
145-68532	5207227124174	20	3000	90	WHITE	1/20	1	10,35
145-68558	5207227268717	20	6500	90	BLACK	1/20	1	10,35
145-68559	5207227268724	20	4000	90	BLACK	1/20	1	10,35
145-68560	5207227268731	20	3000	90	BLACK	1/20	1	10,35

ΕΞΩΤΕΡΙΚΑ LED SLIM SURFACE MOUNTED LED SLIM



225x225mm

Volt: **85-265V 50/60Hz** • LED Type: **SMD2835**

Γωνία Δέσμης Φωτός / Beam Angle: **120°**

Ενεργειακή Κλάση / Energy Class: **F**

Start Time: **0,5sec** • PF > **0,90** • CRI > **80**

Υλικό / Material:

Αλουμίνιο & Πλαστικό / Aluminium & Plastic

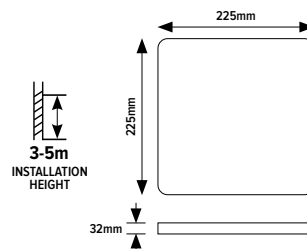
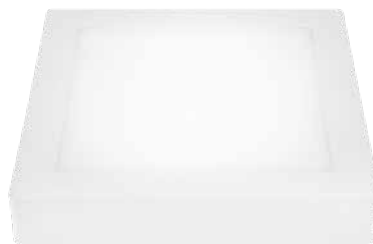

CODE	BARCODE	WATT	KELVIN	LUMEN/WATT	COLOR	PACKING	MOQ	PRICE (€)
145-68533	5207227124181	24	6500	90	WHITE	1/20	1	11,75
145-68534	5207227124198	24	4000	90	WHITE	1/20	1	11,75
145-68535	5207227124204	24	3000	90	WHITE	1/20	1	11,75



225x225x32mm

Volt: **85-265V 50/60Hz** • LED Type: **SMD2835**

Γωνία Δέσμης Φωτός / Beam Angle: **120°**

Ενεργειακή Κλάση / Energy Class: **F**

Start Time: **0,5sec** • PF > **0,90** • CRI > **80**

Υλικό / Material:

Αλουμίνιο & Πλαστικό / Aluminium & Plastic

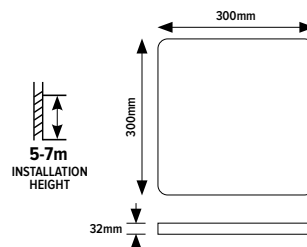
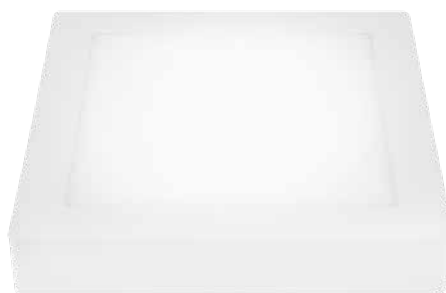

CODE	BARCODE	WATT	KELVIN	LUMEN/WATT	COLOR	PACKING	MOQ	PRICE (€)
145-68536	5207227117619	30	6500	90	WHITE	1/10	1	14,85
145-68537	5207227117626	30	4000	90	WHITE	1/10	1	14,85
145-68538	5207227117633	30	3000	90	WHITE	1/10	1	14,85
145-68561	5207227268748	30	6500	90	BLACK	1/10	1	14,85
145-68562	5207227268755	30	4000	90	BLACK	1/10	1	14,85
145-68563	5207227268762	30	3000	90	BLACK	1/10	1	14,85



70x70x30mm

Volt: **220-240V 50/60Hz** • LED Type: **SMD2835**

Γωνία Δέσμης Φωτός / Beam Angle: **106°**

Ενεργειακή Κλάση / Energy Class: **E**

Start Time: **0,5sec** • PF > **0,50** • CRI > **80**

Υλικό / Material: **Πλαστικό / Plastic**

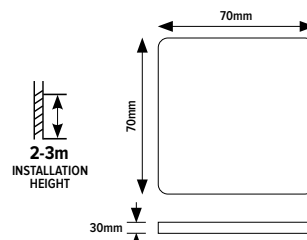

CODE	BARCODE	WATT	KELVIN	LUMEN/WATT	COLOR	PACKING	MOQ	PRICE (€)
145-68654	5207227019265	2	4200	55	WHITE	1/100	1	3,45
145-68655	5207227019241	2	3000	55	WHITE	1/100	1	3,45

ΕΞΩΤΕΡΙΚΑ LED SMD/COB SURFACE MOUNTED LED SMD/COB



NEW

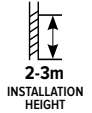
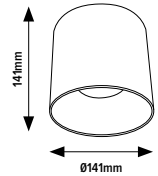

Ø141x141mm

Volt: **220-240V 50/60Hz**

Γωνία Δέσμης Φωτός / Beam Angle: **36°**

Ενεργειακή Κλάση / Energy Class: **F**

LED Type: **SMD5730**

Start Time: **0,5sec** • PF > **0.50** • CRI > **80**

Υλικό / Material: **Αλουμίνιο & Πλαστικό / Aluminium & Plastic**



CODE	BARCODE	WATT	KELVIN	LUMEN/WATT	COLOR	PACKING	MOQ	PRICE (€)
145-65800	5207227282898	20	4000	100	WHITE	1/8	1	54,25
145-65801	5207227282911	20	3000	100	WHITE	1/8	1	54,25



NEW

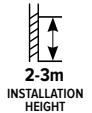
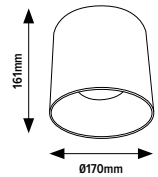

Ø170x161mm

Volt: **220-240V 50/60Hz**

Γωνία Δέσμης Φωτός / Beam Angle: **36°**

Ενεργειακή Κλάση / Energy Class: **F**

LED Type: **SMD5730**

Start Time: **0,5sec** • PF > **0.90** • CRI > **80**

Υλικό / Material: **Αλουμίνιο & Πλαστικό / Aluminium & Plastic**



CODE	BARCODE	WATT	KELVIN	LUMEN/WATT	COLOR	PACKING	MOQ	PRICE (€)
145-65802	5207227282928	30	4000	100	WHITE	1/8	1	72,85
145-65803	5207227282904	30	3000	100	WHITE	1/8	1	72,85



NEW

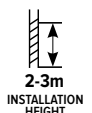
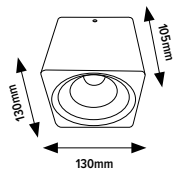

130x130x105mm

Volt: **220-240V 50/60Hz**

Γωνία Δέσμης Φωτός / Beam Angle: **36°**

Ενεργειακή Κλάση / Energy Class: **F**

LED Type: **SMD5730**

Start Time: **0,5sec** • PF > **0.90** • CRI > **80**

Υλικό / Material: **Αλουμίνιο & Πλαστικό / Aluminium & Plastic**



CODE	BARCODE	WATT	KELVIN	LUMEN/WATT	COLOR	PACKING	MOQ	PRICE (€)
145-65806	5207227282874	30	4000	100	WHITE	1/8	1	64,35
145-65807	5207227282881	30	3000	100	WHITE	1/8	1	64,35



Φωτιστικά LED Κρεμαστά
για Επαγγελματικούς Χώρους

Hanging LED Fixtures
for Professional Use

ΕΞΩΤΕΡΙΚΑ ΟΡΟΦΗΣ LED SLIM SURFACE MOUNTED LED SLIM



Volt: **220-240V 50/60Hz** • LED Type: **SMD2835**

3CCT: **3000K/4000K/6500K**

Γωνία Δέσμης Φωτός / Beam Angle: **120°**

Ενεργειακή Κλάση / Energy Class: **G**

Start Time: **0,5sec** • PF > **0,50** • CRI > **80**

Υλικό / Material: **ABS**

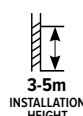

Ø40mm / Ø48mm / Ø60mm



CODE	BARCODE	WATT	KELVIN	DIMENSIONS	WEIGHT	COLOR	PACKING	MOQ	PRICE (€)
145-68571	5207227270994	36	3CCT	Ø400x24mm	0,75kg	WHITE	1/10	1	38,85
145-68572	5207227271014	36	3CCT	Ø400x24mm	0,75kg	BLACK	1/10	1	38,85

CODE	BARCODE	WATT	KELVIN	DIMENSIONS	WEIGHT	COLOR	PACKING	MOQ	PRICE (€)
145-68573	5207227271038	42	3CCT	Ø480x24mm	0,96kg	WHITE	1/5	1	67,25
145-68575	5207227271052	42	3CCT	Ø480x24mm	0,96kg	BLACK	1/5	1	67,25

CODE	BARCODE	WATT	KELVIN	DIMENSIONS	WEIGHT	COLOR	PACKING	MOQ	PRICE (€)
145-68576	5207227271076	48	3CCT	Ø600x24mm	0,96kg	WHITE	1/5	1	84,35
145-68577	5207227271090	48	3CCT	Ø600x24mm	0,96kg	BLACK	1/5	1	84,35

ΡΟΖΕΤΑ ΟΡΟΦΗΣ MG ME NTIZA LAMPHOLDER MG WITH SUSPENDING WIRE



150x40mm

Ντίζα / Suspending wire: **1m**

Υλικό / Material: **Σίδερο / Iron**

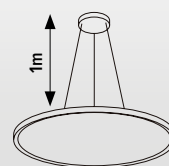

**ΕΦΑΡΜΟΓΗ
ΚΡΕΜΑΣΤΟΥ
ΦΩΤΙΣΤΙΚΟΥ**
HANGING
LIGHT
APPLICATION

CODE	BARCODE	COLOR	PACKING	MOQ	PRICE (€)
145-68578	5207227271113	WHITE	1/40	1	8,25
145-68579	5207227282638	BLACK	1/40	1	8,25

Φωτιστικά LED Εφεδρικού Φωτισμού

Emergency LED
Lighting



ΦΩΤΙΣΤΙΚΟ ΑΣΦΑΛΕΙΑΣ ΜΕ ΔΥΝΑΤΟΤΗΤΑ ΣΥΝΕΧΟΥΣ ΛΕΙΤΟΥΡΓΙΑΣ LED 90min EMERGENCY LIGHT LED 90min CONTINUOUS OPERATION

Volt: **220-240V 50/60Hz**

LED Type: **12 SMD LED**

Ενεργειακή Κλάση / Energy Class: **G**

Υλικό / Material: **Bayblend FR3010,**

Διάφανο / Transparent Polycarbonate

Τύπος Μπαταρίας / Battery Type: **Ni-Cd 3.6V 0.6Ah**

Χρόνος φόρτισης / Charging Time: **24h**

Χρόνος εκφόρτισης / Discharging Time: **1,5h**

Σύνδεση / Connection: **Κλέμμα / Terminal Block**

NEW

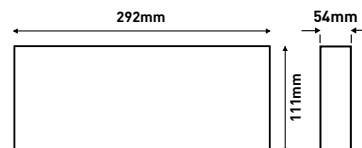

CODE	BARCODE	WATT	KELVIN	LUMEN	DIMENSIONS	COLOR	PACKING	MOQ	PRICE (€)
145-28200	5207227327728	2.7	4000	40/100	202x55x28mm	WHITE	1/40	1	34,65

ΦΩΤΙΣΤΙΚΟ ΑΣΦΑΛΕΙΑΣ ΜΗ ΣΥΝΕΧΟΥΣ ΛΕΙΤΟΥΡΓΙΑΣ LED 90min EMERGENCY LIGHT NON CONTINUOUS OPERATION LED 90min

Volt: **220-240V 50/60Hz**

LED Type: **15 SMD LED**

Ενεργειακή Κλάση / Energy Class: **G**

Υλικό / Material: **Bayblend FR3010,**

Διάφανο / Transparent Polycarbonate

Τύπος Μπαταρίας / Battery Type: **Ni-Cd 3.6V 0.6Ah**

Χρόνος φόρτισης / Charging Time: **24h**

Χρόνος εκφόρτισης / Discharging Time: **1,5h**

Σύνδεση / Connection: **Κλέμμα / Terminal Block**

NEW

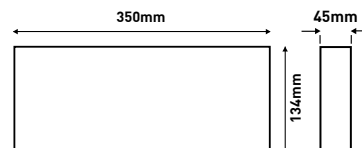

CODE	BARCODE	WATT	KELVIN	LUMEN/WATT	DIMENSIONS	COLOR	PACKING	MOQ	PRICE (€)
145-28201	5207227327735	3	4000	125	350x134x45mm	WHITE	1/40	1	44,75

ΦΩΤΙΣΤΙΚΟ ΑΣΦΑΛΕΙΑΣ ΜΗ ΣΥΝΕΧΟΥΣ ΛΕΙΤΟΥΡΓΙΑΣ LED 90min EMERGENCY LIGHT NON CONTINUOUS OPERATION LED 90min

Volt: **220-240V 50/60Hz**

LED Type: **12 SMD LED**

Ενεργειακή Κλάση / Energy Class: **G**

Υλικό / Material: **Bayblend FR3010,**

Διάφανο / Transparent Polycarbonate

Τύπος Μπαταρίας / Battery Type: **Ni-Cd 3.6V 0.6Ah**

Χρόνος φόρτισης / Charging Time: **24h**

Χρόνος εκφόρτισης / Discharging Time: **1,5h**

Σύνδεση / Connection: **Κλέμμα / Terminal Block**

NEW

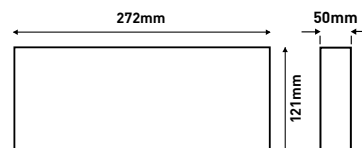

CODE	BARCODE	WATT	KELVIN	LUMEN/WATT	DIMENSIONS	COLOR	PACKING	MOQ	PRICE (€)
145-28202	5207227327742	2.5	4000	40/100	272x121x50mm	WHITE	1/40	1	45,95

ΦΩΤ. ΑΥΤΟΕΛΕΓΧΟΜΕΝΟ ΑΣΦΑΛΕΙΑΣ ΣΥΝΕΧΟΥΣ ΛΕΙΤ. ΧΑΜΗΛΗΣ ΦΩΤΕΙΝΟΤΗΤΑΣ LED 3h
EMERGENCY LIGHT SELF OPTIMIZED CONTINUOUS LOW BRIGHTNESS LED 3h

Volt: **220-240V 50/60Hz**

LED Type: **28 SMD LED**

Ενεργειακή Κλάση / Energy Class: **G**

Υλικό / Material: **ABS & PC**

Τύπος Μπαταρίας / Battery Type: **Ni-Cd 3.6V 1.5Ah**

Χρόνος φόρτισης / Charging Time: **23h**

Χρόνος εκφόρτισης / Discharging Time: **1h, 3h, 8h**

Σύνδεση / Connection: **Κλέμμα / Terminal Block**

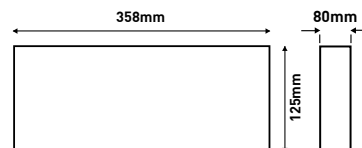

CODE	BARCODE	WATT	KELVIN	LUMEN	DIMENSIONS	COLOR	PACKING	MOQ	PRICE (€)
145-28204	5207227327766	3.8	4000	30/150/300	358x125x80mm	WHITE / GREEN	1/40	1	86,35

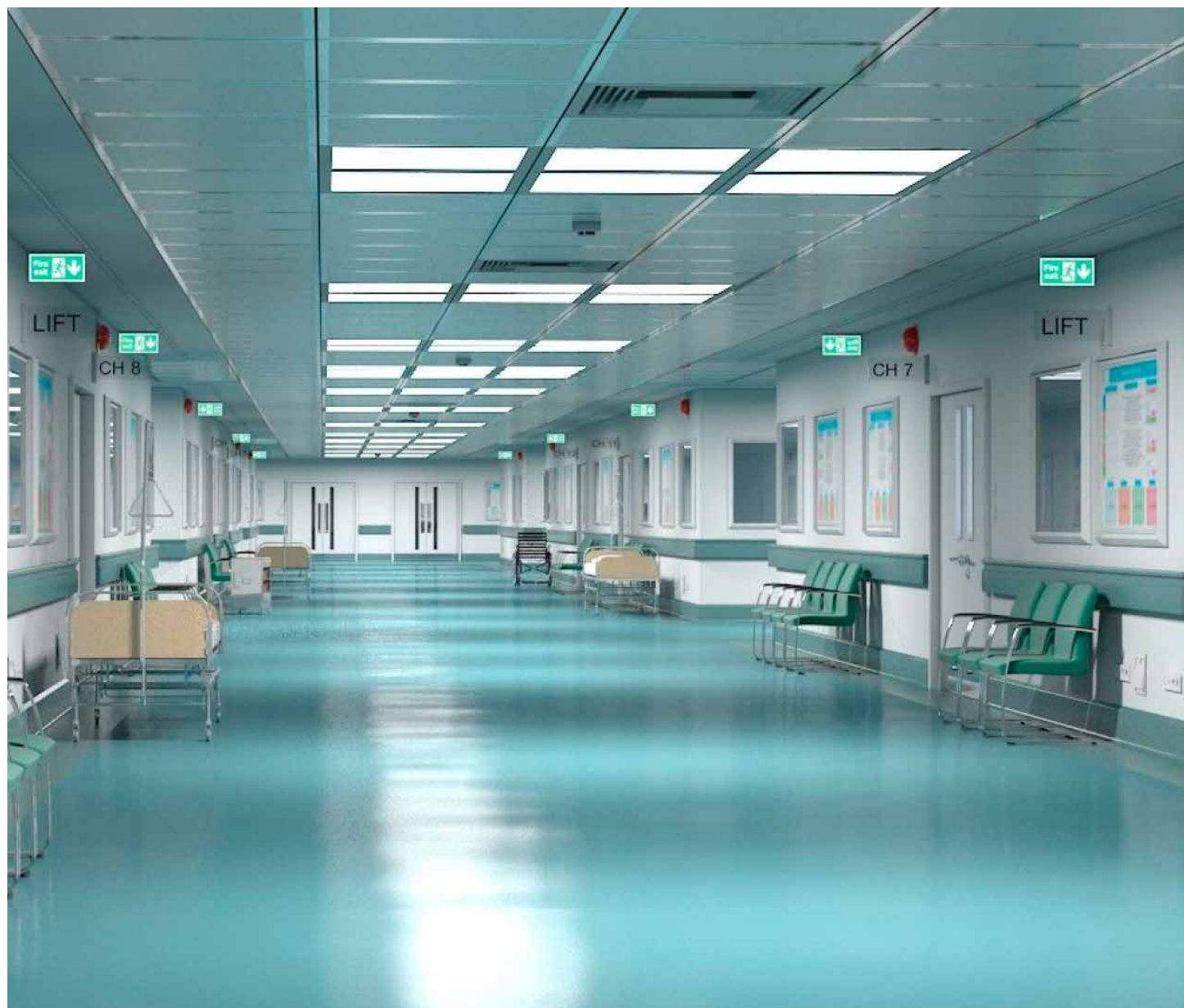

ΕΦΕΔΡΙΚΟΣ ΦΩΤΙΣΜΟΣ 30 SMD LED

EMERGENCY LIGHT 30 SMD LED

Volt: **85-265V 50/60Hz**

LED Type: **30 SMD LED**

Ενεργειακή Κλάση / Energy Class: **G**

Υλικό / Material: **ABS & PC**

Τύπος Μπαταρίας / Battery Type: **Li-ion 1200mAh**

Χρόνος φόρτισης / Charging Time: **20-24h**

Χρόνος εκφόρτισης / Discharging Time: **3-4h**

Σύνδεση / Connection: **Φις / Plug**



3 STICKER SET

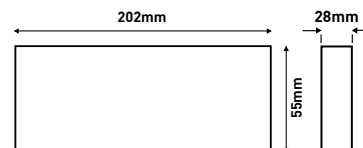

CODE	BARCODE	WATT	KELVIN	LUMEN/WATT	DIMENSIONS	COLOR	PACKING	MOQ	PRICE (€)
145-28000	5207227075544	2	4000	60	202x55x28mm	WHITE	1/40	1	11,65

ΕΦΕΔΡΙΚΟΣ ΦΩΤΙΣΜΟΣ 60 SMD LED

EMERGENCY LIGHT 60 SMD LED

Volt: **220-240V 50/60Hz**

LED Type: **60 SMD LED**

Ενεργειακή Κλάση / Energy Class: **G**

Υλικό / Material: **ABS & PC**

Τύπος Μπαταρίας / Battery Type: **Li-ion 1500mAh**

Χρόνος φόρτισης / Charging Time: **20-24h**

Χρόνος εκφόρτισης / Discharging Time: **2-3h**

Σύνδεση / Connection: **Φις / Plug**



3 STICKER SET

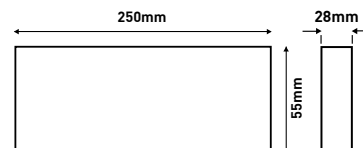

CODE	BARCODE	WATT	KELVIN	LUMEN/WATT	DIMENSIONS	COLOR	PACKING	MOQ	PRICE (€)
145-28001	5207227075551	4	4000	70	250x55x28mm	WHITE	1/40	1	11,45

ΕΦΕΔΡΙΚΟΣ ΦΩΤΙΣΜΟΣ 20 SMD LED

EMERGENCY LIGHT 20 SMD LED

Volt: **220-240V 50/60Hz**

LED Type: **20 SMD LED**

Ενεργειακή Κλάση / Energy Class: **G**

Υλικό / Material: **ABS & PC**

Τύπος Μπαταρίας / Battery Type: **Li-ion 1500mAh**

Χρόνος φόρτισης / Charging Time: **20-24h**

Χρόνος εκφόρτισης / Discharging Time: **2-3h**

Σύνδεση / Connection: **Φις / Plug**



3 STICKER SET

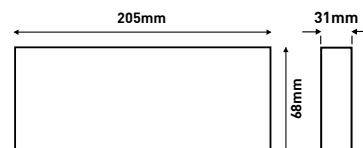

CODE	BARCODE	WATT	KELVIN	LUMEN/WATT	DIMENSIONS	COLOR	PACKING	MOQ	PRICE (€)
145-28010	5207227075568	4	4000	75	250x55x28mm	WHITE	1/40	1	8,45

ΕΦΕΔΡΙΚΟΣ ΦΩΤΙΣΜΟΣ 10 SMD LED EMERGENCY LIGHT 10 SMD LED

Volt: **220-240V 50/60Hz**

LED Type: **10 SMD LED**

Ενεργειακή Κλάση / Energy Class: **G**

Υλικό / Material: **Άκαυστο ABS & PMMA /**

Non-Combustible ABS & PMMA

Τύπος Μπαταρίας / Battery Type: **Li-ion 3,7V 1200mAh**

Χρόνος φόρτισης / Charging Time: **20-24h**

Χρόνος εκφόρτισης / Discharging Time: **3h**

Σύνδεση / Connection: **Κλέμμα / Terminal Block**



Δυνατότητα Χωνευτής
& Εξωτερικής
Τοποθέτησης /
Surface & Recessed
Installation

3 STICKER
SET

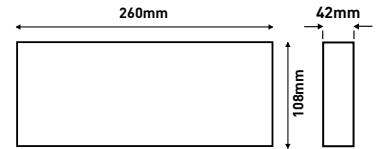

CODE	BARCODE	WATT	KELVIN	LUMEN/WATT	DIMENSIONS	COLOR	PACKING	MOQ	PRICE (€)
145-28100	5207227075575	2	4000	75	260x108x42mm	WHITE	1/20	1	16,85

ΕΦΕΔΡΙΚΟΣ ΦΩΤΙΣΜΟΣ 40 SMD LED EMERGENCY LIGHT 40 SMD LED

Volt: **220-240V 50/60Hz**

LED Type: **40 SMD LED**

Ενεργειακή Κλάση / Energy Class: **G**

Υλικό / Material: **Άκαυστο ABS & PMMA /**

Non-Combustible ABS & PMMA

Τύπος Μπαταρίας / Battery Type: **Li-ion 3,7V 2200mAh**

Χρόνος φόρτισης / Charging Time: **20-24h**

Χρόνος εκφόρτισης / Discharging Time: **1,5h**

Σύνδεση / Connection: **Κλέμμα / Terminal Block**



Δυνατότητα Χωνευτής
& Εξωτερικής
Τοποθέτησης /
Surface & Recessed
Installation

3 STICKER
SET

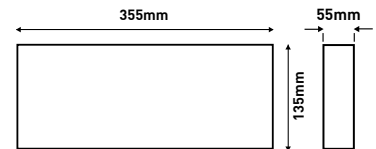

CODE	BARCODE	WATT	KELVIN	LUMEN/WATT	DIMENSIONS	COLOR	PACKING	MOQ	PRICE (€)
145-28110	5207227075605	4	4000	75	355x135x55mm	WHITE	1/10	1	21,85

ΕΦΕΔΡΙΚΟΣ ΦΩΤΙΣΜΟΣ 2 SMD LED EMERGENCY LIGHT 2 SMD LED

Volt: **220-240V 50/60Hz**

LED Type: **2 SMD LED**

Ενεργειακή Κλάση / Energy Class: **G**

Υλικό / Material: **Άκαυστο ABS & PMMA / Non-Combustible ABS & PMMA**

Αυτόματη Δοκιμή Λειτουργίας και Ενδειξης Προβλημάτων / Auto-test Function and Trouble Indicator

Τύπος Μπαταρίας / Battery Type: **Li-ion 3,7V 2200mAh**

Χρόνος φόρτισης / Charging Time: **20-24h**

Χρόνος εκφόρτισης / Discharging Time: **2h**

Σύνδεση / Connection: **Κλέμμα / Terminal Block**

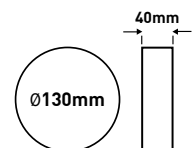

CODE	BARCODE	WATT	KELVIN	LUMEN/WATT	DIMENSIONS	COLOR	PACKING	MOQ	PRICE (€)
145-28102	5207227075599	4	4000	75	250x55x28mm	WHITE	1/20	1	28,45

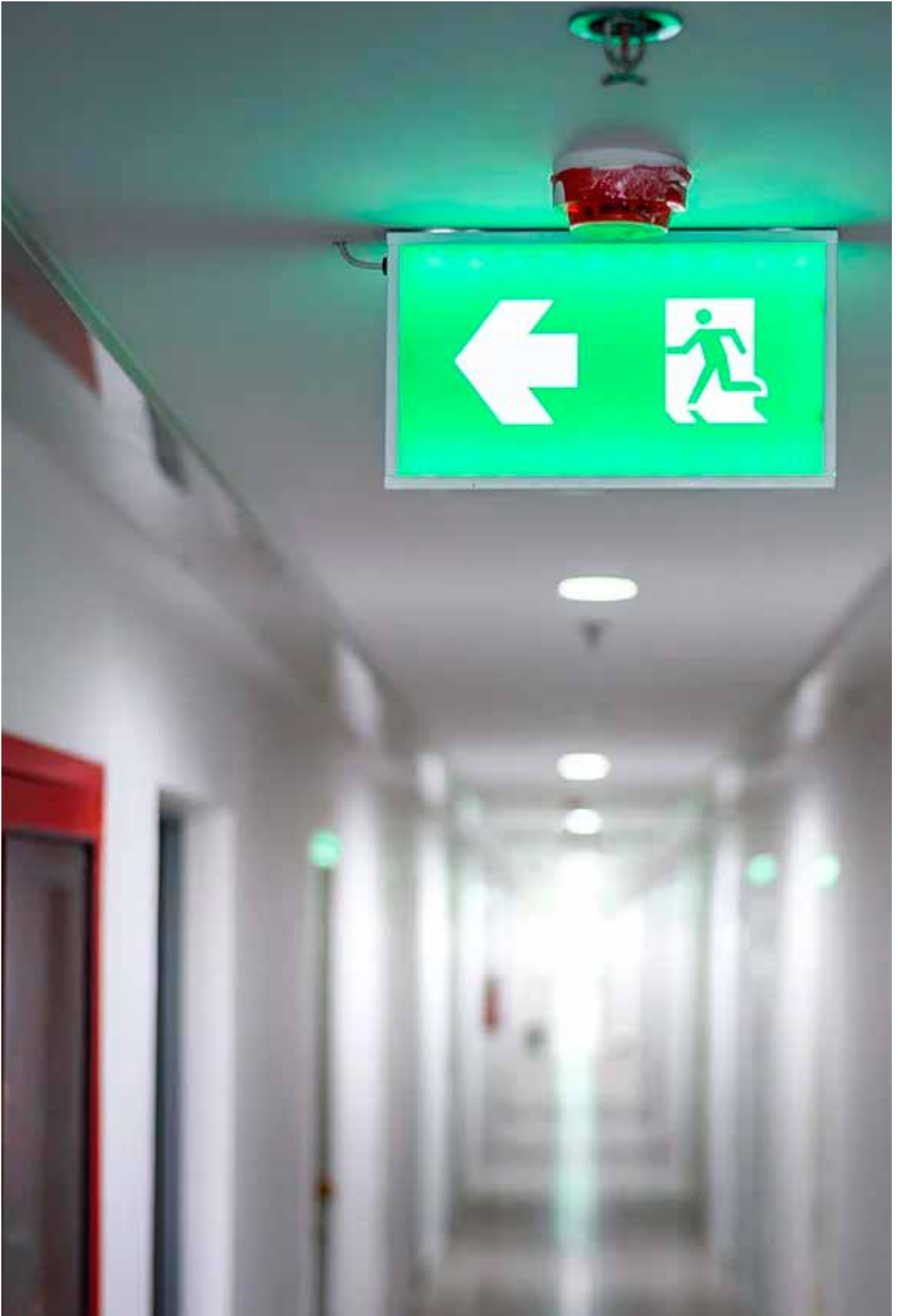

ΧΩΝΕΥΤΟΣ ΕΦΕΔΡΙΚΟΣ ΦΩΤΙΣΜΟΣ 10 SMD LED RECESSED EMERGENCY LIGHT 10 SMD LED

Volt: **220-240V 50/60Hz**

LED Type: **10 SMD LED**

Ενεργειακή Κλάση / Energy Class: **G**

Υλικό / Material: **Άκαυστο ABS & PMMA /**

Non-Combustible ABS & PMMA

Τύπος Μπαταρίας / Battery Type: **Ni-MH 1.2V 1000mAh**

Χρόνος φόρτισης / Charging Time: **24-48h**

Χρόνος εκφόρτισης / Discharging Time: **2-3h**

Σύνδεση / Connection: **Καλώδιο / Wire**



4pcs PVC
STICKERS

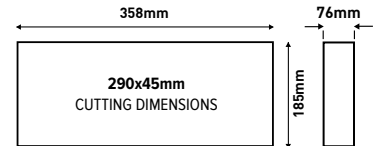

CODE	BARCODE	WATT	KELVIN	LUMEN/WATT	DIMENSIONS	COLOR	PACKING	MOQ	PRICE (€)
145-28500	5207227075629	2	4000	30	358x185x76mm	WHITE	1/10	1	16,85

ΦΩΤΙΣΤΙΚΟ ΑΥΤΟΕΛΕΓΧΟΜΕΝΟ ΜΕ ΣΗΜΑΝΣΗ ΜΗ ΣΥΝΕΧΟΥΣ ΛΕΙΤΟΥΡΓΙΑΣ LED 3h EMERGENCY LIGHT SELF-OPTIMIZED WITH INDICATOR NON CONTINUOUS OPERATION 3h

Volt: **220-240V 50/60Hz**

LED Type: **1 SMD LED**

Ενεργειακή Κλάση / Energy Class: **G**

Υλικό / Material: **ABS,PC & Plexiglass**

Τύπος Μπαταρίας / Battery Type: **Ni-MH 3.6V 1.5Ah**

Χρόνος φόρτισης / Charging Time: **24h**

Χρόνος εκφόρτισης / Discharging Time: **3h**

Σύνδεση / Connection: **Κλέμμα / Terminal Block**

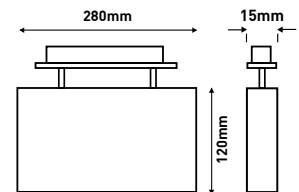

CODE	BARCODE	WATT	KELVIN	LUMEN	DIMENSIONS	COLOR	PACKING	MOQ	PRICE (€)
145-28203	5207227327759	3.8	4000	100	280x120x15mm	WHITE / GREEN	1/40	1	119,65

ΕΦΕΔΡΙΚΟΣ ΦΩΤΙΣΜΟΣ ΟΡΟΦΗΣ-ΤΟΙΧΟΥ SMD LED EMERGENCY LIGHT CEILING-WALL MOUNT SMD LED

Volt: **220-240V 50/60Hz**

LED Type: **12 SMD LED**

Ενεργειακή Κλάση / Energy Class: **G**

Υλικό / Material: **Άλουμίνιο & PMMA / Aluminium & PMMA**

Τύπος Μπαταρίας / Battery Type: **Ni-MH 1.2V 1000mAh**

Χρόνος φόρτισης / Charging Time: **24-48h**

Χρόνος εκφόρτισης / Discharging Time: **3-4h**

Σύνδεση / Connection: **Καλώδιο / Wire**



Κρεμαστή & Εξωτερική
Τοποθέτηση / Suspended
& Surface Installation

4pcs PVC
STICKERS

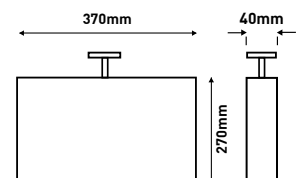

CODE	BARCODE	WATT	KELVIN	LUMEN/WATT	DIMENSIONS	COLOR	PACKING	MOQ	PRICE (€)
145-28400	5207227075612	2	4000	15	358x185x76mm	SILVER	1/20	1	17,85

ΠΛΑΦΟΝΙΕΡΑ LED ΜΕ ΑΝΙΧΝΕΥΤΗ ΚΙΝΗΣΗΣ & ΔΥΝΑΤΟΤΗΤΑ ΕΠΕΚΤΑΣΗΣ

LED CEILING LIGHT WITH MOTION SENSOR, EXPANDABLE



Volt: **220-240V 50/60Hz** • LED Type: **SMD2835**
 Ενεργειακή Κλάση / Energy Class: **G**
 Γωνία Δέσμης Φωτός / Beam Angle: **180° / 360°**
 Start Time: **0,5sec** • PF > **0,90** • CRI > **80** • IK10
 Υλικό / Material: **Πλαστικό (UV Proof) / Plastic (UV Proof)**

Εγκατάσταση / Installation: Ύψος: **3-4m**
 Επιτοίχια: **max 15m** / Wall: **max 15m**
 Οροφής: **2m - 8m** / Ceiling: **2m - 8m**

Χρόνος Καθυστέρησης / Delay Time: **3sec - 12min**
 Επέκταση: **έως 10τεμ.** / Expands: **max 10pcs**
 Σύνδεση / Connection: **Κλέμμα / Terminal Block**

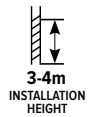
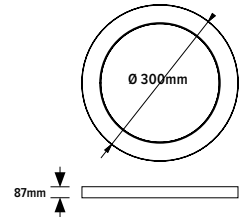

CODE	BARCODE	WATT	KELVIN	LUMEN/W	AMPERAGE	DIMENSIONS	COLOR	PACKING	MOQ	PRICE (€)
145-55301	5206139080899	16	4000	81	300mA	Ø300x87mm	WHITE	1/5	1	47,25

ΠΛΑΦΟΝΙΕΡΑ LED ΜΕ ΑΝΙΧΝΕΥΤΗ ΚΙΝΗΣΗΣ & ΕΦΕΔΡΙΚΟ ΦΩΤΙΣΜΟ

LED CEILING LIGHT WITH MOTION SENSOR & EMERGENCY LIGHT



Volt: **220-240V 50/60Hz** • LED Type: **SMD2835**
 Ενεργειακή Κλάση / Energy Class: **G**
 Γωνία Δέσμης Φωτός / Beam Angle: **180° / 360°**
 Start Time: **0,5sec** • PF > **0,90** • CRI > **80** • IK10
 Υλικό / Material: **Πλαστικό (UV Proof) / Plastic (UV Proof)**

Εγκατάσταση / Installation: Ύψος: **3-4m**
 Επιτοίχια: **max 15m** / Wall: **max 15m**
 Οροφής: **2m - 8m** / Ceiling: **2m - 8m**

Φορτίο Έκτακτης Ανάγκης / Emergency Load: **1,2W DC, 6Led, 80lm**
 Τύπος Μπαταρίας / Battery type: **Lithium 18650, 1500mAh**
 Χρόνος φόρτισης / Battery Charging Time: **7-10 Ημέρες / 7-10 Days**
 Discharging Time: **5h**

Χρόνος Καθυστέρησης / Delay Time: **3sec - 12min**
 Επέκταση: **έως 10τεμ.** / Expands: **max 10pcs**
 Σύνδεση / Connection: **Κλέμμα / Terminal Block**

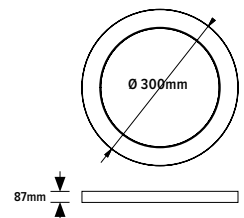

CODE	BARCODE	WATT	KELVIN	LUMEN/W	AMPERAGE	DIMENSIONS	COLOR	PACKING	MOQ	PRICE (€)
145-55302	5206139080905	16	4000	75	600mA	Ø300x87mm	WHITE	1/5	1	56,35

ΠΛΑΦΟΝΙΕΡΑ LED ΜΕ ΔΥΝΑΤΟΤΗΤΑ ΕΠΕΚΤΑΣΗΣ LED CEILING LIGHT EXPANDABLE



Volt: **220-240V 50/60Hz** • LED Type: **SMD2835**
 Ενεργειακή Κλάση / Energy Class: **G**
 Γωνία Δέσμης Φωτός / Beam Angle: **180° / 360°**
 Start Time: **0,5sec** • PF > **0,90** • CRI > **80** • IK10
 Υλικό / Material: **Πλαστικό (UV Proof) / Plastic (UV Proof)**

Εγκατάσταση / Installation: Ύψος: **3-4m**
 Επιτοίχια: **max 15m** / Wall: **max 15m**
 Οροφής: **2m - 8m** / Ceiling: **2m - 8m**

Επέκταση: **έως 10τεμ.** / Expands: **max 10pcs**
 Σύνδεση / Connection: **Κλέμμα / Terminal Block**

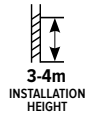
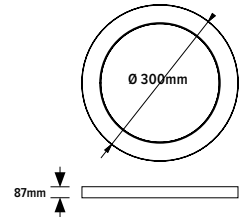

CODE	BARCODE	WATT	KELVIN	LUMEN/W	AMPERAGE	DIMENSIONS	COLOR	PACKING	MOQ	PRICE (€)
145-55307	5207227116308	16	4000	81	300mA	Ø300x87mm	WHITE	1/5	1	32,45

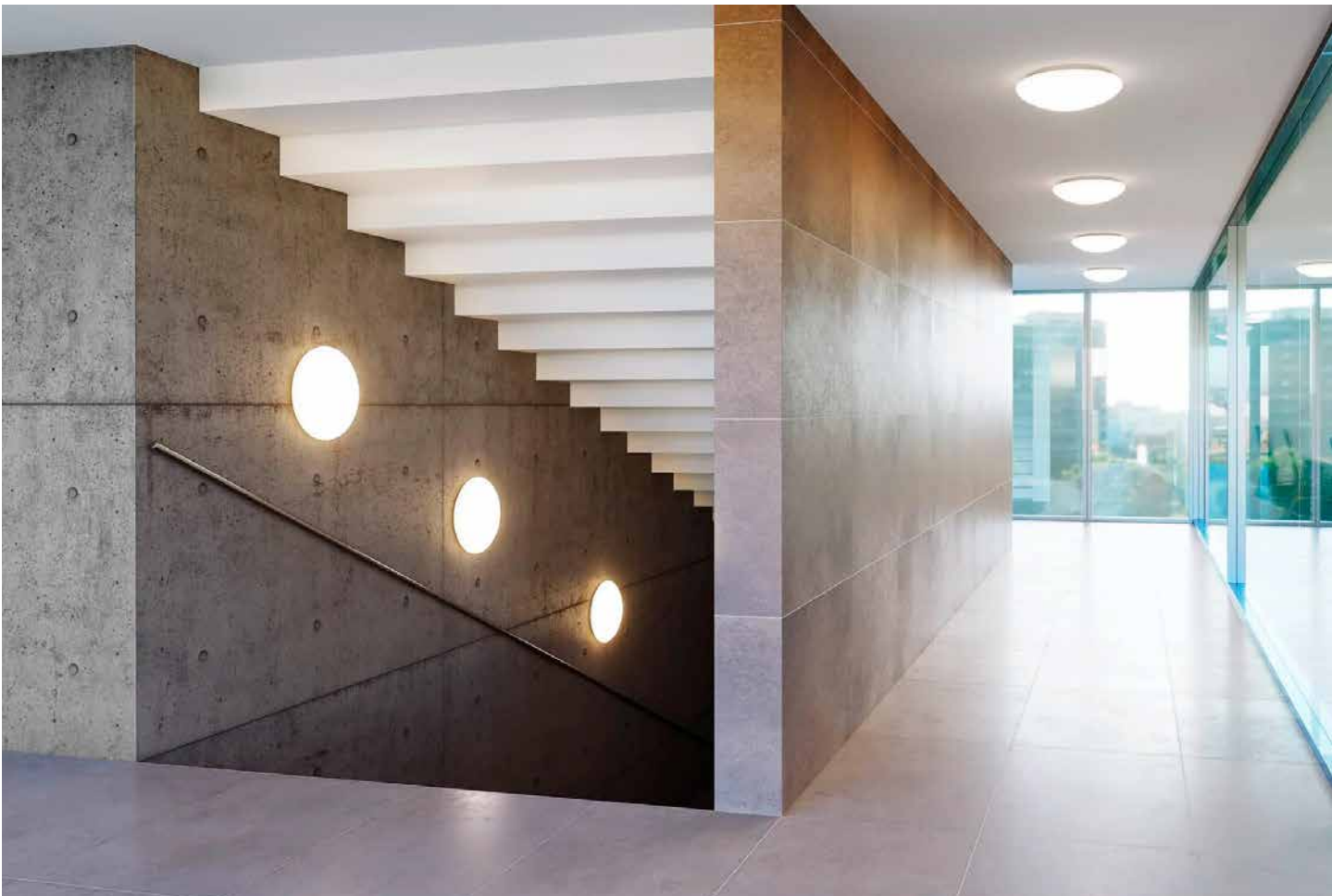

ΧΩΝΕΥΤΟ ΦΩΤΙΣΤΙΚΟ ΑΣΦΑΛΕΙΑΣ ΜΗ ΣΥΝΕΧΟΥΣ ΛΕΙΤΟΥΡΓΙΑΣ LED 90min RECESSED EMERGENCY LIGHT NON CONTINUOUS OPERATION LED 90min

Volt: **220-240V 50/60Hz**

LED Type: **1 SMD LED**

Ενεργειακή Κλάση / Energy Class: **G**

Υλικό / Material: **ABS & PC**

Τύπος Μπαταρίας / Battery Type: **Ni-MH 3.6V 1.5Ah**

Χρόνος φόρτισης / Charging Time: **24h**

Χρόνος εκφόρτισης / Discharging Time: **1,5h**

Σύνδεση / Connection: **Κλέμμα / Terminal Block**

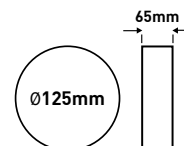

CODE	BARCODE	WATT	KELVIN	LUMEN	DIMENSIONS	COLOR	PACKING	MOQ	PRICE (€)
145-28205	5207227327773	2.4	4000K	160	Ø125x65	WHITE	1/20	1	60,30

ΧΩΝΕΥΤΟΣ ΕΦΕΔΡΙΚΟΣ ΦΩΤΙΣΜΟΣ 2 SMD LED RECESSED EMERGENCY LIGHT 2 SMD LED

Volt: **220-240V 50/60Hz**

LED Type: **2 SMD LED**

Ενεργειακή Κλάση / Energy Class: **G**

Υλικό / Material: **Άκαυστο ABS & PMMA / Non-Combustible ABS & PMMA**

Αυτόματη Δοκιμή Λειτουργίας και Ενδειξης Προβλημάτων / Auto-test Function and Trouble Indicator

Τύπος Μπαταρίας / Battery Type: **Li-ion 3,7V 2200mAh**

Χρόνος φόρτισης / Charging Time: **20-24h**

Χρόνος εκφόρτισης / Discharging Time: **2h**

Σύνδεση / Connection: **Κλέμμα / Terminal Block**

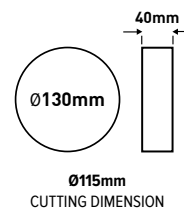

CODE	BARCODE	WATT	KELVIN	LUMEN/WATT	DIMENSIONS	COLOR	PACKING	MOQ	PRICE (€)
145-28510	5207227075636	4	4000K	75	250x55x28mm	WHITE	1/20	1	29,65

ΕΦΕΔΡΙΚΟΣ ΦΩΤΙΣΜΟΣ 2x20 SMD LED EMERGENCY LIGHT 2X20 SMD LED

Volt: **220-240V 50/60Hz**

LED Type: **2x20 SMD LED**

Ενεργειακή Κλάση / Energy Class: **G**

Υλικό / Material: **Άκαυστο ABS & PC/ Non-Combustible ABS & PC**

Τύπος Μπαταρίας / Battery Type: **Li-ion 3,7V 2200mAh**

Χρόνος φόρτισης / Charging Time: **20-24h**

Χρόνος εκφόρτισης / Discharging Time:

Υψηλό / High: 3-4h, Χαμηλό / Low: 5-6h

Σύνδεση / Connection: **Φις / Plug**

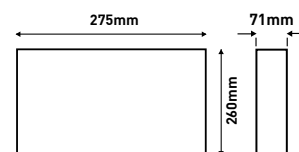

CODE	BARCODE	WATT	KELVIN	LUMEN/WATT	DIMENSIONS	COLOR	PACKING	MOQ	PRICE (€)
145-28600	5207227075643	4	4000K	75	275x260x71mm	WHITE	1/5	1	34,25

Σποτ Χωνευτά
Αλουμινίου
Σταθερά / Κινητά / Στεγανά

Spot Recessed
Aluminum
Fixed / Movable / Waterproof



ΣΠΟΤ ΕΞΩΤΕΡΙΚΑ 3CCT LED SPOT LIGHT SURFACE MOUNTED 3CCT LED



Ø110x65mm

Volt: **220-240V 50/60Hz** • LED Type: **SMD2835**

3CCT: **2700K/4000K/6500K**

Γωνία Δέσμης Φωτός / Beam Angle: **120°** • Ενεργειακή Κλάση / Energy Class: **F**

Start Time: **0,5sec** • PF > **0,50** • CRI > **80**

Υλικό / Material: **Αλουμίνιο & Πλαστικό / Aluminium & Plastic**

Σύνδεση / Connection: **Κλέμμα / Terminal Block**

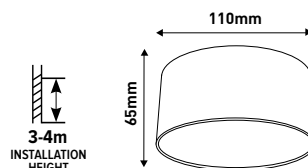

CODE	BARCODE	WATT	AMPERAGE	KELVIN	LUMEN/WATT	COLOR	PACKING	MOQ	PRICE (€)
147-52643	5207227277900	10	250mA	3CCT	89	WHITE	1/20	1	22,35
147-52644	5207227277917	10	250mA	3CCT	86	BLACK	1/20	1	22,35



Ø140x65mm

Volt: **220-240V 50/60Hz** • LED Type: **SMD2835**

3CCT: **2700K/4000K/6500K**

Γωνία Δέσμης Φωτός / Beam Angle: **120°** • Ενεργειακή Κλάση / Energy Class: **F**

Start Time: **0,5sec** • PF > **0,50** • CRI > **80**

Υλικό / Material: **Αλουμίνιο & Πλαστικό / Aluminium & Plastic**

Σύνδεση / Connection: **Κλέμμα / Terminal Block**

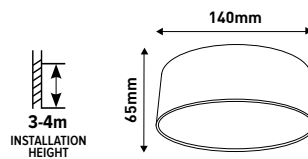

CODE	BARCODE	WATT	AMPERAGE	KELVIN	LUMEN/WATT	COLOR	PACKING	MOQ	PRICE (€)
147-52645	5207227277924	16	400mA	3CCT	95	WHITE	1/20	1	32,45
147-52646	5207227277931	16	400mA	3CCT	91	BLACK	1/20	1	32,45



Ø100x86mm

Volt: **220-240V 50/60Hz** • LED Type: **SMD2835**

3CCT: **2700K/4000K/6500K**

Γωνία Δέσμης Φωτός / Beam Angle: **120°** • Ενεργειακή Κλάση / Energy Class: **F**

Start Time: **0,5sec** • PF > **0,50** • CRI > **80**

Υλικό / Material: **Αλουμίνιο & Πλαστικό / Aluminium & Plastic**

Σύνδεση / Connection: **Κλέμμα / Terminal Block**

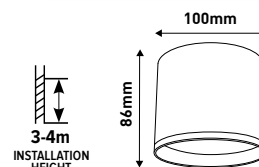

CODE	BARCODE	WATT	AMPERAGE	KELVIN	LUMEN/WATT	COLOR	PACKING	MOQ	PRICE (€)
147-52647	5207227277948	10	250mA	3CCT	65	WHITE	1/20	1	24,25
147-52648	5207227277955	10	250mA	3CCT	62	BLACK	1/20	1	24,25

ΣΠΟΤ ΕΞΩΤΕΡΙΚΑ 3CCT LED SPOT LIGHT SURFACE MOUNTED 3CCT LED



Ø120x86mm

Volt: **220-240V 50/60Hz** • LED Type: **SMD2835**

3CCT: **2700K/4000K/6500K**

Γωνία Δέσμης Φωτός / Beam Angle: **120°** • Ενεργειακή Κλάση / Energy Class: **F**

Start Time: **0,5sec** • PF > **0,50** • CRI > **80**

Υλικό / Material: **Αλουμίνιο & Πλαστικό / Aluminium & Plastic**

Σύνδεση / Connection: **Κλέμμα / Terminal Block**

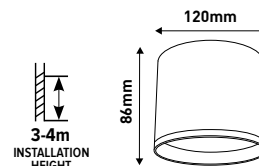

CODE	BARCODE	WATT	AMPERAGE	KELVIN	LUMEN/WATT	COLOR	PACKING	MOQ	PRICE (€)
147-52649	5207227277962	16	400mA	3CCT	62	WHITE	1/20	1	29,60
147-52650	5207227277979	16	400mA	3CCT	58	BLACK	1/20	1	29,60



Ø110x88mm

Volt: **220-240V 50/60Hz** • LED Type: **SMD2835**

3CCT: **2700K/4000K/6500K**

Γωνία Δέσμης Φωτός / Beam Angle: **120°** • Ενεργειακή Κλάση / Energy Class: **F**

Start Time: **0,5sec** • PF > **0,50** • CRI > **80**

Υλικό / Material: **Αλουμίνιο & Πλαστικό / Aluminium & Plastic**

Σύνδεση / Connection: **Κλέμμα / Terminal Block**

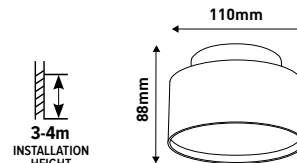

CODE	BARCODE	WATT	AMPERAGE	KELVIN	LUMEN/WATT	COLOR	PACKING	MOQ	PRICE (€)
147-52651	5207227277986	16	400mA	3CCT	50	WHITE	1/20	1	32,15
147-52652	5207227277993	16	400mA	3CCT	48	BLACK	1/20	1	32,15



Ø140x88mm

Volt: **220-240V 50/60Hz** • LED Type: **SMD2835**

3CCT: **2700K/4000K/6500K**

Γωνία Δέσμης Φωτός / Beam Angle: **120°** • Ενεργειακή Κλάση / Energy Class: **F**

Start Time: **0,5sec** • PF > **0,50** • CRI > **80**

Υλικό / Material: **Αλουμίνιο & Πλαστικό / Aluminium & Plastic**

Σύνδεση / Connection: **Κλέμμα / Terminal Block**

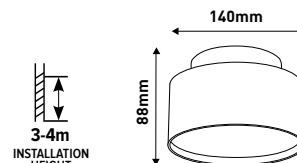

CODE	BARCODE	WATT	AMPERAGE	KELVIN	LUMEN/WATT	COLOR	PACKING	MOQ	PRICE (€)
147-52653	5207227278006	24	600mA	3CCT	75	WHITE	1/20	1	44,45
147-52654	5207227278013	24	600mA	3CCT	72	BLACK	1/20	1	44,45

ΣΠΟΤ ΕΞΩΤΕΡΙΚΑ 3CCT LED SPOT LIGHT SURFACE MOUNTED 3CCT LED



Ø110x125mm

Volt: **220-240V 50/60Hz** • LED Type: **SMD2835**

3CCT: **2700K/4000K/6500K**

Γωνία Δέσμης Φωτός / Beam Angle: **120°** • Ενεργειακή Κλάση / Energy Class: **F**

Start Time: **0,5sec** • PF > **0,50** • CRI > **80**

Υλικό / Material: **Αλουμίνιο & Πλαστικό / Aluminium & Plastic**

Σύνδεση / Connection: **Κλέμμα / Terminal Block**

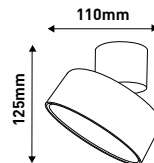

CODE	BARCODE	WATT	AMPERAGE	KELVIN	LUMEN/WATT	COLOR	PACKING	MOQ	PRICE (€)
147-52655	5207227278020	10	250mA	3CCT	68	WHITE	1/20	1	35,15
147-52656	5207227278037	10	250mA	3CCT	65	BLACK	1/20	1	35,15



Ø140x125mm

Volt: **220-240V 50/60Hz** • LED Type: **SMD2835**

3CCT: **2700K/4000K/6500K**

Γωνία Δέσμης Φωτός / Beam Angle: **120°** • Ενεργειακή Κλάση / Energy Class: **F**

Start Time: **0,5sec** • PF > **0,50** • CRI > **80**

Υλικό / Material: **Αλουμίνιο & Πλαστικό / Aluminium & Plastic**

Σύνδεση / Connection: **Κλέμμα / Terminal Block**

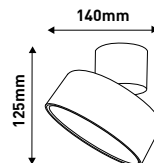

CODE	BARCODE	WATT	AMPERAGE	KELVIN	LUMEN/WATT	COLOR	PACKING	MOQ	PRICE (€)
147-52657	5207227278044	16	400mA	3CCT	87	WHITE	1/20	1	40,45
147-52658	5207227278051	16	400mA	3CCT	84	BLACK	1/20	1	40,45



79x75x150mm

Volt: **220-240V 50/60Hz** • LED Type: **COB1304**

3CCT: **2700K/4000K/6500K**

Γωνία Δέσμης Φωτός / Beam Angle: **24°** • Ενεργειακή Κλάση / Energy Class: **F**

Start Time: **0,5sec** • PF > **0,50** • CRI > **80**

Υλικό / Material: **Αλουμίνιο & Πλαστικό / Aluminium & Plastic**

Σύνδεση / Connection: **Κλέμμα / Terminal Block**

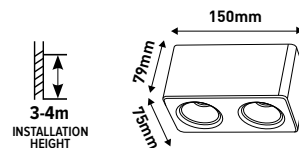

CODE	BARCODE	WATT	AMPERAGE	KELVIN	LUMEN/WATT	COLOR	PACKING	MOQ	PRICE (€)
147-52659	5207227278068	2 x 7	2 x 150mA	3CCT	62	WHITE	1/20	1	44,25
147-52660	5207227278075	2 x 7	2 x 150mA	3CCT	60	BLACK	1/20	1	44,25

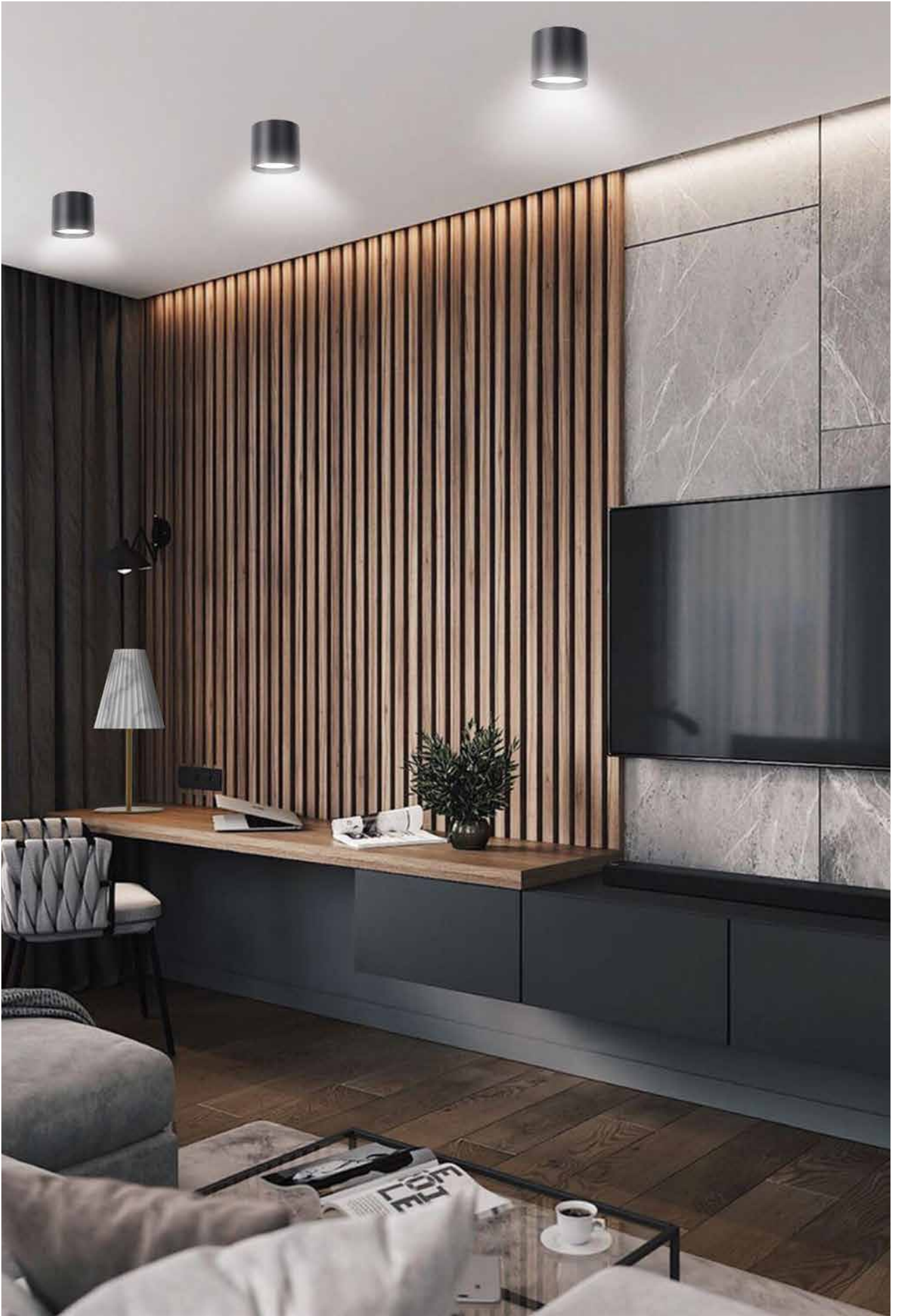

ΣΠΟΤ ΧΩΝΕΥΤΑ ΣΤΑΘΕΡΑ REDO SPOT RECESSED FIXED REDO

Ø95x33mm

Υλικό / Material: **Αλουμίνιο / Aluminium**
Σύνδεση / Connection: **Καλώδιο / Wire**

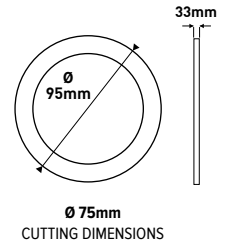

CODE	BARCODE	TYPE	COLOR	PACKING	MOQ	PRICE (€)
147-52530	5207227287930	GU10	WHITE	1/50	1	8,45
147-52531	5207227287954	GU10	BLACK	1/50	1	8,45

ΣΠΟΤ ΧΩΝΕΥΤΑ ΣΤΑΘΕΡΑ ΟΤΤΑΒΙΑ SPOT RECESSED FIXED OTTAVIA

Ø84x33mm

Υλικό / Material: **Αλουμίνιο / Aluminium**
Σύνδεση / Connection: **Καλώδιο / Wire**

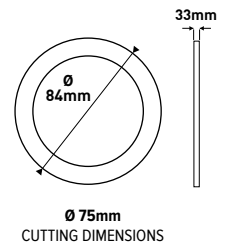

CODE	BARCODE	TYPE	COLOR	PACKING	MOQ	PRICE (€)
147-52532	5207227287978	GU10	WHITE	1/50	1	4,25
147-52533	5207227287992	GU10	BLACK	1/50	1	4,25

ΣΠΟΤ ΧΩΝΕΥΤΑ ΣΤΑΘΕΡΑ ZERMIRA SPOT RECESSED FIXED ZERMIRA

Ø71x34mm

Υλικό / Material: **Αλουμίνιο / Aluminium**
Σύνδεση / Connection: **Καλώδιο / Wire**

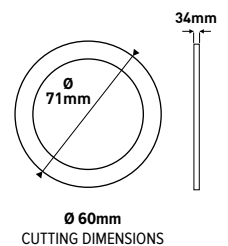

CODE	BARCODE	TYPE	COLOR	PACKING	MOQ	PRICE (€)
147-52534	5207227288012	GU10	WHITE	1/50	1	5,45
147-52535	5207227288036	GU10	BLACK	1/50	1	5,45

ΣΠΟΤ ΧΩΝΕΥΤΑ ΚΙΝΗΤΟ REDO SPOT RECESSED MOVABLE REDO

Ø100x25mm

Υλικό / Material: **Αλουμίνιο / Aluminium**
Σύνδεση / Connection: **Καλώδιο / Wire**

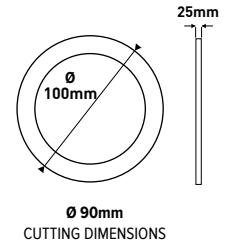

CODE	BARCODE	TYPE	COLOR	PACKING	MOQ	PRICE (€)
147-52540	5207227288050	GU10	WHITE	1/50	1	9,15
147-52541	5207227288074	GU10	BLACK	1/50	1	9,15

ΣΠΟΤ ΧΩΝΕΥΤΟ ΣΤΑΘΕΡΟ ΣΤΕΓΑΝΟ TEX SPOT RECESSED FIXED WATERPROOF TEX

Ø92x42mm

Υλικό / Material: **Αλουμίνιο / Aluminium**
Σύνδεση / Connection: **Καλώδιο / Wire**

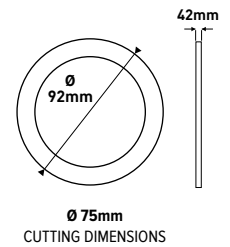

CODE	BARCODE	TYPE	COLOR	PACKING	MOQ	PRICE (€)
147-52120	5207227288098	GU10	WHITE	1/50	1	7,75

ΣΠΟΤ ΧΩΝΕΥΤΟ ΣΤΑΘΕΡΟ SPOT RECESSED FIXED

Ø89x45mm

Υλικό / Material: **Αλουμίνιο / Aluminium**
Σύνδεση / Connection: **Καλώδιο / Wire**

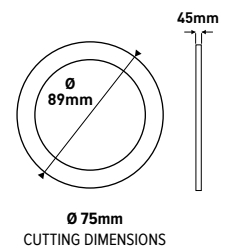

CODE	BARCODE	TYPE	COLOR	PACKING	MOQ	PRICE (€)
147-52121	5207227288111	GU10	WHITE	1/50	1	6,65

ΣΠΟΤ ΧΩΝΕΥΤΑ ΣΤΑΘΕΡΑ SPOT RECESSED FIXED

Ø82mm

Όνομαστική Ισχύς / Nominal Power:

max 7W led

Υλικό / Material:

Αλουμίνιο / Aluminium

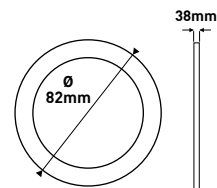

Ø 75mm
CUTTING DIMENSIONS

CODE	BARCODE	Volt	TYPE	COLOR	PACKING	MOQ	PRICE (€)
147-52100	5207227019159	220-240V	GU10	WHITE	1/100	1	5,85
147-52101	5207227019173	220-240V	GU10	SATIN	1/100	1	7,05

82x82mm

Όνομαστική Ισχύς / Nominal Power:

max 7W led

Υλικό / Material:

Αλουμίνιο / Aluminium

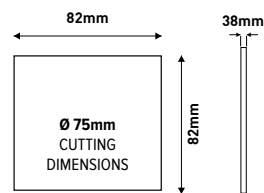

Ø 75mm
CUTTING DIMENSIONS

CODE	BARCODE	Volt	TYPE	COLOR	PACKING	MOQ	PRICE (€)
147-52110	5206139305107	220-240V	GU10	WHITE	1/100	1	6,45
147-52111	5206139305114	220-240V	GU10	SATIN	1/100	1	7,25



ΣΠΟΤ ΧΩΝΕΥΤΑ ΣΤΑΘΕΡΑ SPOT RECESSED FIXED

Ø80mm

Ονομαστική Ισχύς / Nominal Power:

max 7W led

Υλικό / Material:

Αλουμίνιο / Aluminium

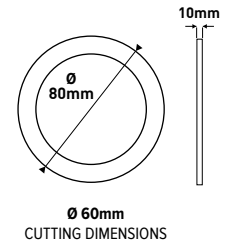
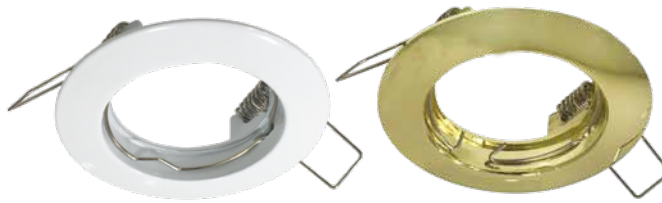

CODE	BARCODE	Volt	TYPE	COLOR	PACKING	MOQ	PRICE (€)
147-52510	5207227030864	220-240V	GU10	WHITE	1/100	1	2,35
147-52511	5207227125584	220-240V	GU10	BLACK	1/100	1	2,35
147-52513	5207227030888	220-240V	GU10	SATIN NICKEL	1/100	1	2,75
147-55610	5206139300102	12V	G5.3	WHITE	5/100	1	2,15
147-55617	5207227060243	12V	G5.3	BLACK	5/100	1	2,15
147-55611	5206139300119	12V	G5.3	GOLD	5/100	1	2,35
147-55612	5206139300126	12V	G5.3	NICKEL	5/100	1	2,35
147-55613	5206139300133	12V	G5.3	SATIN NICKEL	5/100	1	2,35
147-55614	5206139300140	12V	G5.3	SATIN GOLD	5/100	1	2,35
147-55615	5206139300157	12V	G5.3	ANTIQUE BRASS	5/100	1	2,35
147-55616	5206139300164	12V	G5.3	ANTIQUE COPPER	5/100	1	2,35

ΔΑΧΤΥΛΙΔΙ ΓΙΑ ΣΠΟΤΑΚΙΑ SPOT RINGS SILVER

CODE	BARCODE	WEIGHT	COLOR	PACKING	MOQ	PRICE (€)
147-55603	5207227293054	0,013kg	Μεταλλικό Ασημί / Metallic Silver	20/2000	1	1,50

ΣΠΟΤ ΧΩΝΕΥΤΑ ΝΙΚΗΤΑ SPOT RECESSED MOVABLE

Ø83mm

Ονομαστική Ισχύς / Nominal Power:

max 7W led

Υλικό / Material:

Αλουμίνιο / Aluminium

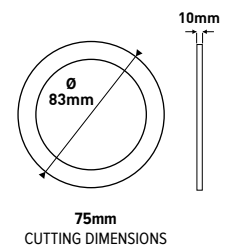

CODE	BARCODE	Volt	TYPE	COLOR	PACKING	MOQ	PRICE (€)
147-52520	5207227030901	220-240V	GU10	WHITE	1/100	1	3,25
147-52521	5207227125607	220-240V	GU10	BLACK	1/100	1	3,25
147-52523	5207227030925	220-240V	GU10	SATIN NICKEL	1/100	1	3,95
147-55620	5206139300201	12V	G5.3	BLACK	5/100	1	2,95
147-55621	5206139300218	12V	G5.3	WHITE	5/100	1	2,95
147-55622	5206139300225	12V	G5.3	GOLD	5/100	1	3,45
147-55623	5207227060311	12V	G5.3	NICKEL	5/100	1	3,45
147-55624	5206139300249	12V	G5.3	SATIN NICKEL	5/100	1	3,45
147-55625	5206139300256	12V	G5.3	SATIN GOLD	5/100	1	3,45
147-55626	5206139300263	12V	G5.3	ANTIQUE BRASS	5/100	1	3,45
147-55627	5206139300270	12V	G5.3	ANTIQUE COPPER	5/100	1	3,45

ΣΠΟΤ ΧΩΝΕΥΤΑ ΣΤΑΘΕΡΑ SPOT RECESSED FIXED

78x78mm

Ονομαστική Ισχύς / Nominal Power:

max 7W led

Υλικό / Material:

Αλουμίνιο / Aluminium

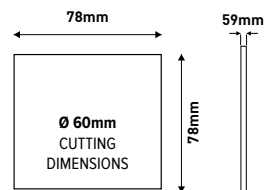

CODE	BARCODE	Volt	TYPE	COLOR	PACKING	MOQ	PRICE (€)
147-52630	5207227059612	12V	G5.3	WHITE	5/100	1	1,95
147-52631	5207227059636	12V	G5.3	BLACK	5/100	1	1,95
147-52632	5207227072277	12V	G5.3	NICKEL SATIN	5/100	1	2,15

ΣΠΟΤ ΧΩΝΕΥΤΑ ΝΙΚΗΤΑ SPOT RECESSED MOVABLE

78x78mm

Ονομαστική Ισχύς / Nominal Power:

max 7W led

Υλικό / Material:

Αλουμίνιο / Aluminium

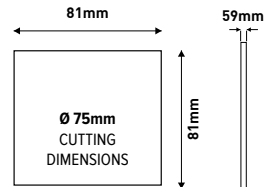

CODE	BARCODE	Volt	TYPE	COLOR	PACKING	MOQ	PRICE (€)
147-52640	5207227059674	12V	G5.3	WHITE	5/100	1	2,95
147-52641	5207227059698	12V	G5.3	BLACK	5/100	1	2,95
147-52642	5207227072284	12V	G5.3	SATIN NICKEL	5/100	1	3,25



Γύψινα Φωτιστικά LED Εσωτερικού χώρου

Plaster Lights LED
Indoor use



ΣΠΟΤ ΜΟΝΟ SINGLE SPOT

100x100x40mm

Ονομαστική Ισχύς / Nominal Power:

max 6W led

Υλικό / Material:

Γύψος / Plaster

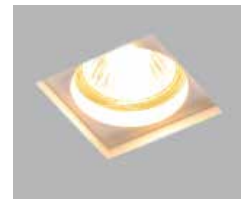
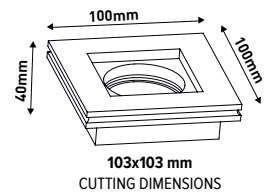

CODE	BARCODE	Operating Temperature	TYPE	COLOR	PACKING	MOQ	PRICE (€)
147-53200	5207227067686	-20/+70°C	GU10	WHITE	1/30	1	5,25

ΣΠΟΤ ΜΟΝΟ SINGLE SPOT

120x120x62mm

Ονομαστική Ισχύς / Nominal Power:

max 6W led

Υλικό / Material:

Αλουμίνιο & Γύψος / Aluminium & Plaster

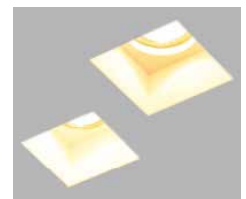
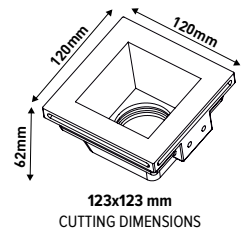

CODE	BARCODE	Operating Temperature	TYPE	COLOR	PACKING	MOQ	PRICE (€)
147-53202	5207227067723	-20/+70°C	GU10	WHITE	1/24	1	6,75

ΣΠΟΤ ΔΙΠΛΟ DOUBLE SPOT

214x117x60mm

Ονομαστική Ισχύς / Nominal Power:

max 6W led

Υλικό / Material:

Γύψος / Plaster

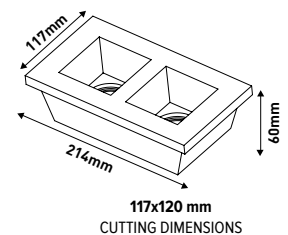

CODE	BARCODE	Operating Temperature	TYPE	COLOR	PACKING	MOQ	PRICE (€)
147-53203	5207227067747	-20/+70°C	GU10	WHITE	1/12	1	12,90

ΣΠΟΤ ΜΟΝΟ SINGLE SPOT

Ø100x40mm

Ονομαστική Ισχύς / Nominal Power:

max 6W led

Υλικό / Material:

Γύψος / Plaster

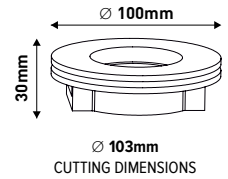

CODE	BARCODE	Operating Temperature	TYPE	COLOR	PACKING	MOQ	PRICE (€)
147-53201	5207227067709	-20/+70°C	GU10	WHITE	1/30	1	5,25

ΣΠΟΤ ΜΟΝΟ SINGLE SPOT

Ø100x40mm

Ονομαστική Ισχύς / Nominal Power:

max 6W led

Υλικό / Material:

Γύψος / Plaster

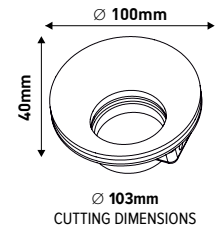

CODE	BARCODE	Operating Temperature	TYPE	COLOR	PACKING	MOQ	PRICE (€)
147-53205	5207227067785	-20/+70°C	GU10	WHITE	1/30	1	5,80

ΣΠΟΤ ΔΙΠΛΟ ΕΜΜΕΣΟΥ ΦΩΤΙΣΜΟΥ DOUBLE INDIRECT LIGHTING SPOT

250x135x56mm

Ονομαστική Ισχύς / Nominal Power:

max 6W led

Υλικό / Material:

Γύψος / Plaster

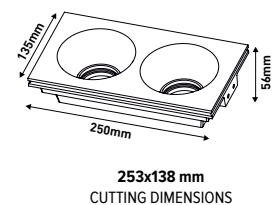

CODE	BARCODE	Operating Temperature	TYPE	COLOR	PACKING	MOQ	PRICE (€)
147-53206	5207227067808	-20/+70°C	GU10	WHITE	1/6	1	15,35

ΣΠΟΤ ΜΟΝΟ SINGLE SPOT

80x80x55mm

Ονομαστική Ισχύς / Nominal Power:

max 6W led

Υλικό / Material:

Αλουμίνιο & Γύψος / Aluminium & Plaster

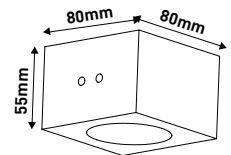

83x83 mm
CUTTING DIMENSIONS



CODE	BARCODE	Operating Temperature	TYPE	COLOR	PACKING	MOQ	PRICE (€)
147-53204	5207227067761	-20/+70°C	GU10	WHITE	1/30	1	6,85

ΣΠΟΤ ΠΑΡΑΛΛΗΛΟΓΡΑΜΜΟ SPOT PARALLELOGRAM



360x130x60cm

LED Type: **LED CREE XP-E** • Volt: **220-240V 50/60Hz**

Γωνία Δέσμης Φωτός / Beam Angle: **110°**

Ενεργειακή Κλάση / Energy Class: **F**

Start Time: **0,5sec** • PF > **0,50** • CRI > **80**

Θερμοκρασία Λειτουργίας / Operating Temperature: **-20/+70°C**

Υλικό / Material: **Γύψος / Plaster**

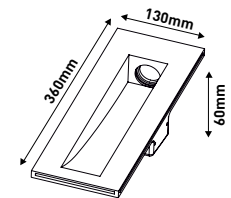

363x133mm
CUTTING DIMENSIONS



CODE	BARCODE	WATT	KELVIN	LUMEN/WATT	COLOR	PACKING	MOQ	PRICE (€)
147-53207	5207227067822	1	3000	80	WHITE	1/6	1	30,85



230x145x50cm

LED Type: **LED CREE XP-E** • Volt: **220-240V 50/60Hz**

Γωνία Δέσμης Φωτός / Beam Angle: **110°**

Ενεργειακή Κλάση / Energy Class: **F**

Start Time: **0,5sec** • PF > **0,50** • CRI > **80**

Θερμοκρασία Λειτουργίας / Operating Temperature: **-20/+70°C**

Υλικό / Material: **Γύψος / Plaster**

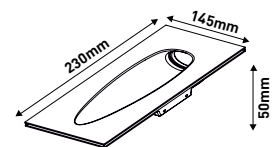

233x148mm
CUTTING DIMENSIONS



CODE	BARCODE	WATT	KELVIN	LUMEN/WATT	COLOR	PACKING	MOQ	PRICE (€)
147-53208	5207227067846	1	3000	80	WHITE	1/6	1	31,90

ΑΠΛΙΚΑ ΤΟΙΧΟΥ ΟΒΑΛ MEDIUM OVAL WALL LIGHT MEDIUM

150x120x100mm

Ονομαστική Ισχύς / Nominal Power:

max 6W led

Υλικό / Material:

Γύψος / Plaster

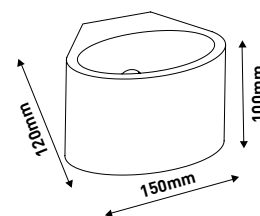

CODE	BARCODE	Operating Temperature	TYPE	COLOR	PACKING	MOQ	PRICE (€)
147-53300	5207227067860	-20/+70°C	G9	WHITE	1/12	1	23,85

ΑΠΛΙΚΑ ΤΟΙΧΟΥ ΚΥΒΟΣ CUBE WALL LIGHT

150x140x150mm

Ονομαστική Ισχύς / Nominal Power:

max 6W led

Υλικό / Material:

Γύψος / Plaster

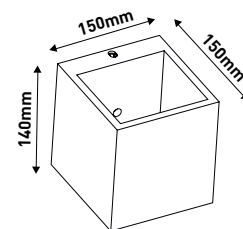
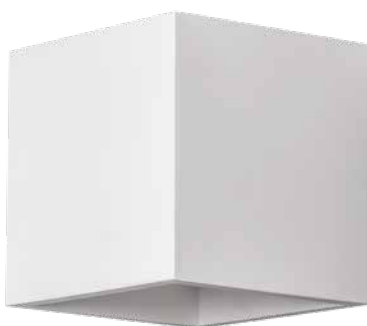

CODE	BARCODE	Operating Temperature	TYPE	COLOR	PACKING	MOQ	PRICE (€)
147-53301	5207227067884	-20/+70°C	G9	WHITE	1/8	1	28,55

ΑΠΛΙΚΑ ΤΟΙΧΟΥ ΣΤΡΟΓΓΥΛΗ ROUND WALL LIGHT



Ø155mm

LED Type: **2x3W LED CREE XP-E** • Volt: **220-240V 50/60Hz**

Γωνία Δέσμης Φωτός / Beam Angle: **110°**

Ενεργειακή Κλάση / Energy Class: **F**

Start Time: **0,5sec** • PF > **0,50** • CRI > **80**

Θερμοκρασία Λειτουργίας / Operating Temperature: **-20/+70°C**

Υλικό / Material: **Γύψος / Plaster**

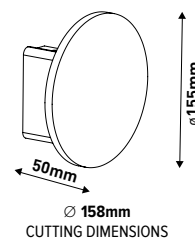
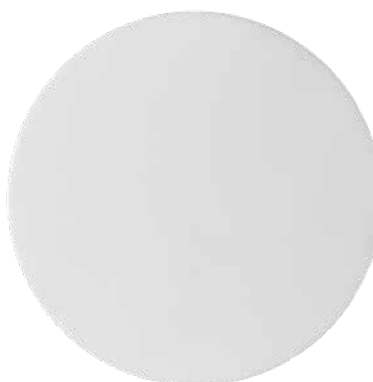

CODE	BARCODE	WATT	KELVIN	LUMEN/WATT	COLOR	PACKING	MOQ	PRICE (€)
147-53305	5207227067969	1	3000	85	WHITE	1/6	1	49,80

ΑΠΛΙΚΑ ΤΟΙΧΟΥ ΟΒΑΛ ΜΕΔΙΟΜ ΟVAL WALL LIGHT MEDIUM

200x80x120mm

Ονομαστική Ισχύς / Nominal Power:

max 6W led

Υλικό / Material:

Γύψος / Plaster



0,670kg



IP20



3 YEARS WARRANTY

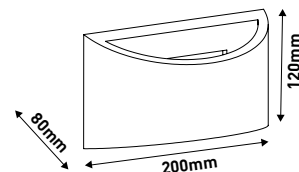

CODE	BARCODE	Operating Temperature	TYPE	COLOR	PACKING	MOQ	PRICE (€)
147-53302	5207227067907	-20/+70°C	G9	WHITE	1/6	1	23,65

ΑΠΛΙΚΑ ΤΟΙΧΟΥ ΟΒΑΛ LARGE ΟVAL WALL LIGHT LARGE

300x140x95mm

Ονομαστική Ισχύς / Nominal Power:

max 2 x 6W led

Υλικό / Material:

Γύψος / Plaster



1,330kg



IP20



3 YEARS WARRANTY

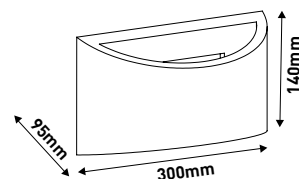

CODE	BARCODE	Operating Temperature	TYPE	COLOR	PACKING	MOQ	PRICE (€)
147-53303	5207227067921	-20/+70°C	G9	WHITE	1/6	1	32,85

ΑΠΛΙΚΑ ΤΟΙΧΟΥ ΟΒΑΛ SMALL ΟVAL WALL LIGHT SMALL

180x95x90mm

Ονομαστική Ισχύς / Nominal Power:

max 6W led

Υλικό / Material:

Γύψος / Plaster



0,700kg



IP20



3 YEARS WARRANTY

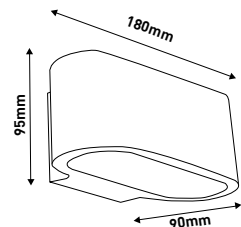

CODE	BARCODE	Operating Temperature	TYPE	COLOR	PACKING	MOQ	PRICE (€)
147-53304	5207227067945	-20/+70°C	G9	WHITE	1/8	1	22,45

ΑΠΛΙΚΑ ΤΟΙΧΟΥ ΣΤΡΟΓΓΥΛΗ ROUND WALL LIGHT

Ø165x180x80mm

Ονομαστική Ισχύς / Nominal Power:

max 6W led

Υλικό / Material:

Γύψος / Plaster



1,340kg



IP20



3 YEARS WARRANTY

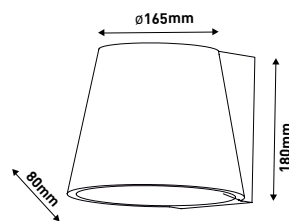

CODE	BARCODE	Operating Temperature	TYPE	COLOR	PACKING	MOQ	PRICE (€)
147-53306	5207227067983	-20/+70°C	E14	WHITE	1/8	1	30,85

ΑΠΛΙΚΑ ΤΟΙΧΟΥ ΟΒΑΛ OVAL WALL LIGHT

310x150x110mm

Ονομαστική Ισχύς / Nominal Power:

max 6W led

Υλικό / Material:

Γύψος / Plaster



1,390kg



IP20



3 YEARS WARRANTY

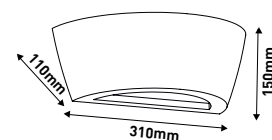

CODE	BARCODE	Operating Temperature	TYPE	COLOR	PACKING	MOQ	PRICE (€)
147-53307	5207227068003	-20/+70°C	E14	WHITE	1/9	1	29,65

ΑΠΛΙΚΑ ΤΟΙΧΟΥ ΟΒΑΛ OVAL WALL LIGHT

310x125x95mm

Ονομαστική Ισχύς / Nominal Power:

max 6W led

Υλικό / Material:

Γύψος / Plaster



0,980kg



IP20



3 YEARS WARRANTY

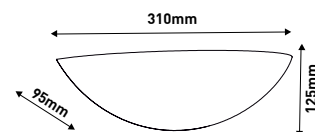

CODE	BARCODE	Operating Temperature	TYPE	COLOR	PACKING	MOQ	PRICE (€)
147-53308	5207227068027	-20/+70°C	E14	WHITE	1/6	1	27,85



ΑΠΛΙΚΑ ΤΟΙΧΟΥ UP-DOWN ΣΤΡΟΓΓΥΛΗ ROUND UP-DOWN WALL LIGHT

Ø75x250x100mm

Ονομαστική Ισχύς / Nominal Power:

max 2x6W led

Υλικό / Material:

Γύψος / Plaster



1,690kg



IP20



3 YEARS WARRANTY

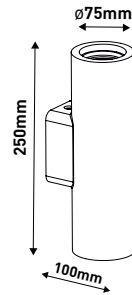

CODE	BARCODE	Operating Temperature	TYPE	COLOR	PACKING	MOQ	PRICE (€)
147-53310	5207227068065	-20/+70°C	GU10	WHITE	1/6	1	25,65

ΑΠΛΙΚΑ ΤΟΙΧΟΥ UP-DOWN ΤΕΤΡΑΓΩΝΗ SQUARE UP-DOWN WALL LIGHT

Ø75x250x100mm

Ονομαστική Ισχύς / Nominal Power:

max 2x6W led

Υλικό / Material:

Γύψος / Plaster



1,720kg



IP20



3 YEARS WARRANTY

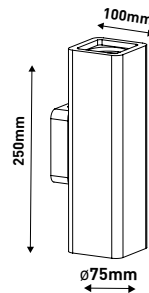

CODE	BARCODE	Operating Temperature	TYPE	COLOR	PACKING	MOQ	PRICE (€)
147-53311	5207227068089	-20/+70°C	GU10	WHITE	1/6	1	25,25

ΑΠΛΙΚΑ ΤΟΙΧΟΥ UP-DOWN UP-DOWN WALL LIGHT

120x240x100mm

Ονομαστική Ισχύς / Nominal Power:

max 2x6W led

Υλικό / Material:

Γύψος / Plaster



1,710kg



IP20



3 YEARS WARRANTY

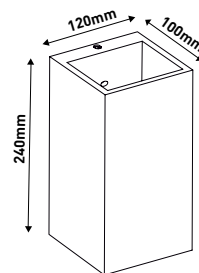

CODE	BARCODE	Operating Temperature	TYPE	COLOR	PACKING	MOQ	PRICE (€)
147-53313	5207227068126	-20/+70°C	GU10	WHITE	1/6	1	24,25

ΑΠΛΙΚΑ ΤΟΙΧΟΥ UP-DOWN ΔΙΑΤΡΗΤΗ ROUND UP-DOWN WALL LIGHT PERFORATED

Ø110x305mm

Ονομαστική Ισχύς / Nominal Power:

max 2x6W led

Υλικό / Material:

Γύψος / Plaster



1,150kg



IP20



3 YEARS WARRANTY

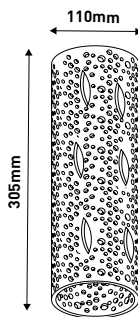

CODE	BARCODE	Operating Temperature	TYPE	COLOR	PACKING	MOQ	PRICE (€)
147-53312	5207227068102	-20/+70°C	E14	WHITE	1/6	1	32,95

ΑΠΛΙΚΑ ΤΟΙΧΟΥ ΟΒΑΛ ΔΙΑΤΡΗΤΗ ΟΒΑΛ WALL LIGHT PERFORATED

150x125x115mm

Ονομαστική Ισχύς / Nominal Power:

max 6W led

Υλικό / Material:

Γύψος / Plaster



0,900kg



IP20



3 YEARS WARRANTY

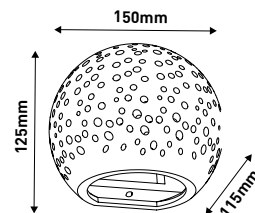

CODE	BARCODE	Operating Temperature	TYPE	COLOR	PACKING	MOQ	PRICE (€)
147-53309	5207227068041	-20/+70°C	G9	WHITE	1/8	1	18,85

ΑΠΛΙΚΑ ΤΟΙΧΟΥ ΟΒΑΛ 90° OVAL 90° WALL LIGHT

200x200x70mm

Ονομαστική Ισχύς / Nominal Power:

max 2x6W led

Υλικό / Material:

Γύψος / Plaster



1,410kg



IP20



3 YEARS WARRANTY

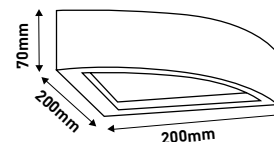

CODE	BARCODE	Operating Temperature	TYPE	COLOR	PACKING	MOQ	PRICE (€)
147-53314	5207227068140	-20/+70°C	E14	WHITE	1/4	1	29,35



ΣΠΟΤ ΧΩΝΕΥΤΑ LED
Αρχιτεκτονικά & Γραμμικά

Spot Recessed LED
Architectural & Linear

ΣΠΟΤ ΧΩΝΕΥΤΟ ΚΙΝΗΤΟ LED SPOT LED LIGHT RECESSED MOVABLE



Ø100x84mm

Volt: **230V 50/60Hz** • LED Type: **COB CREE**

Γωνία Δέσμης Φωτός / Beam Angle: **24°**

Ενεργειακή Κλάση / Energy Class: **G**

Start Time: **0,5sec** • PF > **0,50** • CRI > **80**

Υλικό / Material: **Αλουμίνιο & Πλαστικό / Aluminium & Plastic**

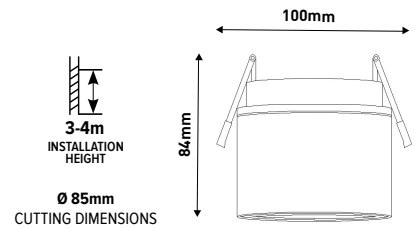

CODE	BARCODE	WATT	KELVIN	LUMEN/WATT	COLOR	PACKING	MOQ	PRICE (€)
145-59801	5207227151132	12	4000	85	WHITE	1/20	1	35,25
145-59802	5207227151149	12	4000	85	BLACK	1/20	1	35,25

ΣΠΟΤ ΧΩΝΕΥΤΟ ΓΡΑΜΜΙΚΟ MONO LED LINEAR SPOT LED RECESSED SINGLE LIGHT



361x85x40mm

Volt: **220-240V 50/60Hz** • LED Type: **SMD3030**

Γωνία Δέσμης Φωτός / Beam Angle: **24°**

Ενεργειακή Κλάση / Energy Class: **E**

Start Time: **0,5sec** • PF > **0,50** • CRI > **80**

Υλικό / Material: **Αλουμίνιο & PC / Aluminium & PC**

Σύνδεση / Connection: **Κλέμμα / Terminal Block**

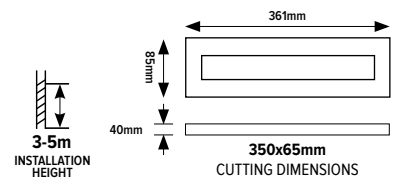

CODE	BARCODE	WATT	KELVIN	LUMEN/WATT	COLOR	PACKING	MOQ	PRICE (€)
145-55092	5207227061660	12	4000	90	WHITE/BLACK	1/20	1	45,30

Φωτιστικά Γραμμικά LED ΧΩΝΕΥΤΑ & ΕΞΩΤΕΡΙΚΑ

Linear Light Fixture LED
recessed & surface

New LED linear luminaires Superb performance and flexibility!

Νέα σειρά γραμμικού φωτισμού LED Απόδοση και ευελιξία στο ζενίθ!

Η άρτια γκάμα των γραμμικών φωτιστικών EUROLAMP στη διάθεση σας! Εξωτερικά ή χωνετά, θα τα βρείτε σε εκδόσεις που θα καλύψουν κάθε απαίτηση σε επαγγελματικό ή οικιακό χώρο, για αποτελεσματικό και οικονομικό φωτισμό.

The complete range of EUROLAMP's linear luminaires is here! Surface, hanging, or recessed, you will find them in versions that will meet every requirement in a professional or domestic space for efficient and economical lighting.

- ▶ **Φωτιστικά που κρύβουν μέσα τους led chips με την τεχνολογία της Samsung και αποδίδουν άριστη φωτεινότητα μέχρι και 180Lm/W**

Lights that hide inside them led chips with Samsung technology bringing excellent performance with brightness up to 180Lm/W

- ▶ **Εξοπλισμένα με τροφοδοτικά Lifud παρέχουν 5 χρόνια εγγύηση για την άρτια λειτουργία τους και την υποστήριξη DALI για τη διαχείριση φωτός**

Equipped with Lifud drivers, they provide 5-year warranty of perfect operation and DALI support for light management

*DALI: Digital Addressable Lighting Interface / Διεύθυνση ψηφιακής διεπαφής φωτισμού

- ▶ **Δυνατότητα ρύθμισης της έντασης του φωτός και επιλογής χρώματος για τη βαφή του σκάφους**

Ability for light dimming or not and choosing a color to paint the casing



ΓΡΑΜΜΙΚΑ ΕΞΩΤΕΡΙΚΑ ΦΩΤΙΣΤΙΚΑ LED LINEAR LIGHT FIXTURE LED



ΜΕ ΕΝΣΩΜΑΤΩΜΕΝΗ ΠΛΑΚΕΤΑ LED
WITH INTEGRATED LED BOARD

SAMSUNG LED INVETRONIC DRIVER



Volt: **220-240V 50/60Hz** • LED Type: **SMD2835**

Γωνία Δέσμης Φωτός / Beam Angle: **110°**

Ενεργειακή Κλάση / Energy Class: **F**

Start Time: **0,5sec** • PF > **0,90** • CRI > **80**

Υλικό / Material: **Αλουμίνιο & Πλαστικό / Aluminium & Plastic**

Σύνδεση / Connection: **Καλώδιο / Wire**



-20 | +45 °C



NON DIMMABLE



CLASS II



FLICKER FREE



50.000h



ON OFF

15.000



IP20



COLOR BLACK



3 YEARS WARRANTY

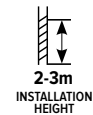

CODE	BARCODE	WATT	KELVIN	LUMEN/WATT	DIMENSIONS	WEIGHT	PACKING	MOQ	PRICE (€)
145-56800	5207227123573	20	4000	100	600x50x57mm	0,950Kg	1/6	1	49,85
145-56801	5207227123580	20	3000	95	600x50x57mm	0,950Kg	1/6	1	49,85
145-56802	5207227123597	30	4000	100	900x50x57mm	1,430Kg	1/6	1	65,65
145-56803	5207227123603	30	3000	95	900x50x57mm	1,430Kg	1/6	1	65,65
145-56804	5207227123610	40	4000	100	1200x50x57mm	1,900Kg	1/6	1	72,50
145-56805	5207227123627	40	3000	95	1200x50x57mm	1,900Kg	1/6	1	72,50
145-56806	5207227123634	50	4000	100	1500x50x57mm	2,400Kg	1/6	1	92,50
145-56807	5207227123641	50	3000	95	1500x50x57mm	2,400Kg	1/6	1	92,50



ΓΡΑΜΜΙΚΑ ΧΩΝΕΥΤΑ ΦΩΤΙΣΤΙΚΑ LED LINEAR RECESSED LIGHT FIXTURE LED



130-180Lm/W

Volt: **220-240V 50/60Hz** • LED Type: **SMD2835**

Γωνία Δέσμης Φωτός / Beam Angle: **110°**

Ενεργειακή Κλάση / Energy Class: **E (130Lm/W) / C (180Lm/W)**

Start Time: **0,5sec** • PF > **0,90** • CRI > **80**

Υλικό / Material: **Αλουμίνιο & Πλαστικό / Aluminium & Plastic**

Σύνδεση / Connection: **Καλώδιο / Wire**



ΕΠΙΛΟΓΗ / CHOICE



ΧΡΩΜΑ ΤΗΣ ΕΠΙΛΟΓΗΣ ΣΑΣ

COLOR OF YOUR CHOICE

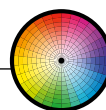

CODE	BARCODE	WATT	Lm/W	KELVIN	DIMENSIONS	WEIGHT	COLOR	PACKING	MOQ	PRICE (€)
145-50100	5207227303043	40	130	6500	1000x50x30mm	1,3kg	WHITE	1	1	69,60
145-50101	5207227303050	40	130	4000	1000x50x30mm	1,3kg	WHITE	1	1	69,60
145-50102	5207227303067	40	130	3000	1000x50x30mm	1,3kg	WHITE	1	1	69,60
145-50103	5207227303074	40	130	6500	1000x50x30mm	1,3kg	BLACK	1	1	69,60
145-50104	5207227303081	40	130	4000	1000x50x30mm	1,3kg	BLACK	1	1	69,60
145-50105	5207227303098	40	130	3000	1000x50x30mm	1,3kg	BLACK	1	1	69,60

CODE	BARCODE	WATT	Lm/W	KELVIN	DIMENSIONS	WEIGHT	COLOR	PACKING	MOQ	PRICE (€)
145-50110	5207227303104	48	130	6500	1200x50x30mm	1,56kg	WHITE	1	1	83,15
145-50111	5207227303111	48	130	4000	1200x50x30mm	1,56kg	WHITE	1	1	83,15
145-50112	5207227303128	48	130	3000	1200x50x30mm	1,56kg	WHITE	1	1	83,15
145-50113	5207227303135	48	130	6500	1200x50x30mm	1,56kg	BLACK	1	1	83,15
145-50114	5207227303142	48	130	4000	1200x50x30mm	1,56kg	BLACK	1	1	83,15
145-50115	5207227303159	48	130	3000	1200x50x30mm	1,56kg	BLACK	1	1	83,15

CODE	BARCODE	WATT	Lm/W	KELVIN	DIMENSIONS	WEIGHT	COLOR	PACKING	MOQ	PRICE (€)
145-50120	5207227303166	60	130	6500	1500x50x30mm	1,95kg	WHITE	1	1	108,50
145-50121	5207227303173	60	130	4000	1500x50x30mm	1,95kg	WHITE	1	1	108,50
145-50122	5207227303180	60	130	3000	1500x50x30mm	1,95kg	WHITE	1	1	108,50
145-50123	5207227303197	60	130	6500	1500x50x30mm	1,95kg	BLACK	1	1	108,50
145-50124	5207227303203	60	130	4000	1500x50x30mm	1,95kg	BLACK	1	1	108,50
145-50125	5207227303210	60	130	3000	1500x50x30mm	1,95kg	BLACK	1	1	108,50

CODE	BARCODE	WATT	Lm/W	KELVIN	DIMENSIONS	WEIGHT	COLOR	PACKING	MOQ	PRICE (€)
145-50130	5207227303227	80	130	6500	2000x50x30mm	2,6kg	WHITE	1	1	131,20
145-50131	5207227303234	80	130	4000	2000x50x30mm	2,6kg	WHITE	1	1	131,20
145-50132	5207227303241	80	130	3000	2000x50x30mm	2,6kg	WHITE	1	1	131,20
145-50133	5207227303258	80	130	6500	2000x50x30mm	2,6kg	BLACK	1	1	131,20
145-50134	5207227303265	80	130	4000	2000x50x30mm	2,6kg	BLACK	1	1	131,20
145-50135	5207227303272	80	130	3000	2000x50x30mm	2,6kg	BLACK	1	1	131,20



CODE	BARCODE	WATT	Lm/W	KELVIN	DIMENSIONS	WEIGHT	COLOR	PACKING	MOQ	PRICE (€)
145-50200	5207227303289	37,5	180	6500	1000x50x30mm	1,3kg	WHITE	1	1	89,40
145-50201	5207227303296	37,5	180	4000	1000x50x30mm	1,3kg	WHITE	1	1	89,40
145-50202	5207227303302	37,5	180	3000	1000x50x30mm	1,3kg	WHITE	1	1	89,40
145-50203	5207227303319	37,5	180	6500	1000x50x30mm	1,3kg	BLACK	1	1	89,40
145-50204	5207227303326	37,5	180	4000	1000x50x30mm	1,3kg	BLACK	1	1	89,40
145-50205	5207227303333	37,5	180	3000	1000x50x30mm	1,3kg	BLACK	1	1	89,40

CODE	BARCODE	WATT	Lm/W	KELVIN	DIMENSIONS	WEIGHT	COLOR	PACKING	MOQ	PRICE (€)
145-50210	5207227303340	43,2	180	6500	1200x50x30mm	1,56kg	WHITE	1	1	103,50
145-50211	5207227303357	43,2	180	4000	1200x50x30mm	1,56kg	WHITE	1	1	103,50
145-50212	5207227303364	43,2	180	3000	1200x50x30mm	1,56kg	WHITE	1	1	103,50
145-50213	5207227303371	43,2	180	6500	1200x50x30mm	1,56kg	BLACK	1	1	103,50
145-50214	5207227303388	43,2	180	4000	1200x50x30mm	1,56kg	BLACK	1	1	103,50
145-50215	5207227303395	43,2	180	3000	1200x50x30mm	1,56kg	BLACK	1	1	103,50

CODE	BARCODE	WATT	Lm/W	KELVIN	DIMENSIONS	WEIGHT	COLOR	PACKING	MOQ	PRICE (€)
145-50220	5207227303401	51,7	180	6500	1500x50x30mm	1,95kg	WHITE	1	1	119,60
145-50221	5207227303418	51,7	180	4000	1500x50x30mm	1,95kg	WHITE	1	1	119,60
145-50222	5207227303425	51,7	180	3000	1500x50x30mm	1,95kg	WHITE	1	1	119,60
145-50223	5207227303432	51,7	180	6500	1500x50x30mm	1,95kg	BLACK	1	1	119,60
145-50224	5207227303449	51,7	180	4000	1500x50x30mm	1,95kg	BLACK	1	1	119,60
145-50225	5207227303456	51,7	180	3000	1500x50x30mm	1,95kg	BLACK	1	1	119,60

CODE	BARCODE	WATT	Lm/W	KELVIN	DIMENSIONS	WEIGHT	COLOR	PACKING	MOQ	PRICE (€)
145-50230	5207227303463	71,4	180	6500	2000x50x30mm	2,6kg	WHITE	1	1	151,25
145-50231	5207227303470	71,4	180	4000	2000x50x30mm	2,6kg	WHITE	1	1	151,25
145-50232	5207227303487	71,4	180	3000	2000x50x30mm	2,6kg	WHITE	1	1	151,25
145-50233	5207227303494	71,4	180	6500	2000x50x30mm	2,6kg	BLACK	1	1	151,25
145-50234	5207227303500	71,4	180	4000	2000x50x30mm	2,6kg	BLACK	1	1	151,25
145-50235	5207227303517	71,4	180	3000	2000x50x30mm	2,6kg	BLACK	1	1	151,25

ΓΡΑΜΜΙΚΑ ΕΞΩΤΕΡΙΚΑ ΦΩΤΙΣΤΙΚΑ LED LINEAR SURFACE LIGHT FIXTURE LED



130-180Lm/W

Volt: **220-240V 50/60Hz** • LED Type: **SMD2835**

Γωνία Δέσμης Φωτός / Beam Angle: **110°**

Ενεργειακή Κλάση / Energy Class: **E (130Lm/W) / C (180Lm/W)**

Start Time: **0,5sec** • PF > **0,90** • CRI > **80**

Υλικό / Material: **Αλουμίνιο & Πλαστικό / Aluminium & Plastic**

Σύνδεση / Connection: **Καλώδιο / Wire**



ΕΠΙΛΟΓΗ / CHOICE

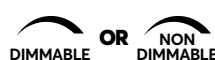

ΧΡΩΜΑ ΤΗΣ ΕΠΙΛΟΓΗΣ ΣΑΣ

COLOR OF YOUR CHOICE

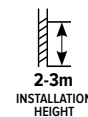
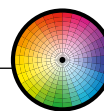

CODE	BARCODE	WATT	Lm/W	KELVIN	DIMENSIONS	WEIGHT	COLOR	PACKING	MOQ	PRICE (€)
145-50400	5207227303524	40	130	6500	1000x65x45mm	1,3kg	WHITE	1	1	81,20
145-50401	5207227303531	40	130	4000	1000x65x45mm	1,3kg	WHITE	1	1	81,20
145-50402	5207227303548	40	130	3000	1000x65x45mm	1,3kg	WHITE	1	1	81,20
145-50403	5207227303555	40	130	6500	1000x65x45mm	1,3kg	BLACK	1	1	81,20
145-50404	5207227303562	40	130	4000	1000x65x45mm	1,3kg	BLACK	1	1	81,20
145-50405	5207227303579	40	130	3000	1000x65x45mm	1,3kg	BLACK	1	1	81,20

CODE	BARCODE	WATT	Lm/W	KELVIN	DIMENSIONS	WEIGHT	COLOR	PACKING	MOQ	PRICE (€)
145-50410	5207227303586	48	130	6500	1200x65x45mm	1,56kg	WHITE	1	1	96,40
145-50411	5207227303593	48	130	4000	1200x65x45mm	1,56kg	WHITE	1	1	96,40
145-50412	5207227303609	48	130	3000	1200x65x45mm	1,56kg	WHITE	1	1	96,40
145-50413	5207227303616	48	130	6500	1200x65x45mm	1,56kg	BLACK	1	1	96,40
145-50414	5207227303623	48	130	4000	1200x65x45mm	1,56kg	BLACK	1	1	96,40
145-50415	5207227303630	48	130	3000	1200x65x45mm	1,56kg	BLACK	1	1	96,40

CODE	BARCODE	WATT	Lm/W	KELVIN	DIMENSIONS	WEIGHT	COLOR	PACKING	MOQ	PRICE (€)
145-50420	5207227303647	60	130	6500	1500x65x45mm	1,95kg	WHITE	1	1	119,20
145-50421	5207227303654	60	130	4000	1500x65x45mm	1,95kg	WHITE	1	1	119,20
145-50422	5207227303661	60	130	3000	1500x65x45mm	1,95kg	WHITE	1	1	119,20
145-50423	5207227303678	60	130	6500	1500x65x45mm	1,95kg	BLACK	1	1	119,20
145-50424	5207227303685	60	130	4000	1500x65x45mm	1,95kg	BLACK	1	1	119,20
145-50425	5207227303692	60	130	3000	1500x65x45mm	1,95kg	BLACK	1	1	119,20

CODE	BARCODE	WATT	Lm/W	KELVIN	DIMENSIONS	WEIGHT	COLOR	PACKING	MOQ	PRICE (€)
145-50430	5207227303708	80	130	6500	2000x65x45mm	2,6kg	WHITE	1	1	152,40
145-50431	5207227303715	80	130	4000	2000x65x45mm	2,6kg	WHITE	1	1	152,40
145-50432	5207227303722	80	130	3000	2000x65x45mm	2,6kg	WHITE	1	1	152,40
145-50433	5207227303739	80	130	6500	2000x65x45mm	2,6kg	BLACK	1	1	152,40
145-50434	5207227303746	80	130	4000	2000x65x45mm	2,6kg	BLACK	1	1	152,40
145-50435	5207227303753	80	130	3000	2000x65x45mm	2,6kg	BLACK	1	1	152,40

CODE	BARCODE	WATT	Lm/W	KELVIN	DIMENSIONS	WEIGHT	COLOR	PACKING	MOQ	PRICE (€)
145-50440	5207227303760	120	130	6500	3000x65x45mm	3,9kg	WHITE	1	1	226,20
145-50441	5207227303777	120	130	4000	3000x65x45mm	3,9kg	WHITE	1	1	226,20
145-50442	5207227303784	120	130	3000	3000x65x45mm	3,9kg	WHITE	1	1	226,20
145-50443	5207227303791	120	130	6500	3000x65x45mm	3,9kg	BLACK	1	1	226,20
145-50444	5207227303807	120	130	4000	3000x65x45mm	3,9kg	BLACK	1	1	226,20
145-50445	5207227303814	120	130	3000	3000x65x45mm	3,9kg	BLACK	1	1	226,20



CODE	BARCODE	WATT	Lm/W	KELVIN	DIMENSIONS	WEIGHT	COLOR	PACKING	MOQ	PRICE (€)
145-50500	5207227303821	35,7	180	6500	1000x65x45mm	1,3kg	WHITE	1	1	104,95
145-50501	5207227303838	35,7	180	4000	1000x65x45mm	1,3kg	WHITE	1	1	104,95
145-50502	5207227303845	35,7	180	3000	1000x65x45mm	1,3kg	WHITE	1	1	104,95
145-50503	5207227303852	35,7	180	6500	1000x65x45mm	1,3kg	BLACK	1	1	104,95
145-50504	5207227303869	35,7	180	4000	1000x65x45mm	1,3kg	BLACK	1	1	104,95
145-50505	5207227303876	35,7	180	3000	1000x65x45mm	1,3kg	BLACK	1	1	104,95

CODE	BARCODE	WATT	Lm/W	KELVIN	DIMENSIONS	WEIGHT	COLOR	PACKING	MOQ	PRICE (€)
145-50510	5207227303883	43,2	180	6500	1200x65x45mm	1,56kg	WHITE	1	1	121,60
145-50511	5207227303890	43,2	180	4000	1200x65x45mm	1,56kg	WHITE	1	1	121,60
145-50512	5207227303906	43,2	180	3000	1200x65x45mm	1,56kg	WHITE	1	1	121,60
145-50513	5207227303913	43,2	180	6500	1200x65x45mm	1,56kg	BLACK	1	1	121,60
145-50514	5207227303920	43,2	180	4000	1200x65x45mm	1,56kg	BLACK	1	1	121,60
145-50515	5207227303937	43,2	180	3000	1200x65x45mm	1,56kg	BLACK	1	1	121,60

CODE	BARCODE	WATT	Lm/W	KELVIN	DIMENSIONS	WEIGHT	COLOR	PACKING	MOQ	PRICE (€)
145-50520	5207227303944	57,2	180	6500	1500x65x45mm	1,95kg	WHITE	1	1	139,85
145-50521	5207227303951	57,2	180	4000	1500x65x45mm	1,95kg	WHITE	1	1	139,85
145-50522	5207227303968	57,2	180	3000	1500x65x45mm	1,95kg	WHITE	1	1	139,85
145-50523	5207227303975	57,2	180	6500	1500x65x45mm	1,95kg	BLACK	1	1	139,85
145-50524	5207227303982	57,2	180	4000	1500x65x45mm	1,95kg	BLACK	1	1	139,85
145-50525	5207227303999	57,2	180	3000	1500x65x45mm	1,95kg	BLACK	1	1	139,85

CODE	BARCODE	WATT	Lm/W	KELVIN	DIMENSIONS	WEIGHT	COLOR	PACKING	MOQ	PRICE (€)
145-50530	5207227304002	71,4	180	6500	2000x65x45mm	2,6kg	WHITE	1	1	168,80
145-50531	5207227304019	71,4	180	4000	2000x65x45mm	2,6kg	WHITE	1	1	168,80
145-50532	5207227304026	71,4	180	3000	2000x65x45mm	2,6kg	WHITE	1	1	168,80
145-50533	5207227304033	71,4	180	6500	2000x65x45mm	2,6kg	BLACK	1	1	168,80
145-50534	5207227304040	71,4	180	4000	2000x65x45mm	2,6kg	BLACK	1	1	168,80
145-50535	5207227304057	71,4	180	3000	2000x65x45mm	2,6kg	BLACK	1	1	168,80

CODE	BARCODE	WATT	Lm/W	KELVIN	DIMENSIONS	WEIGHT	COLOR	PACKING	MOQ	PRICE (€)
145-50540	5207227304064	107,1	180	6500	3000x65x45mm	3,9kg	WHITE	1	1	265,80
145-50541	5207227304071	107,1	180	4000	3000x65x45mm	3,9kg	WHITE	1	1	265,80
145-50542	5207227304088	107,1	180	3000	3000x65x45mm	3,9kg	WHITE	1	1	265,80
145-50543	5207227304095	107,1	180	6500	3000x65x45mm	3,9kg	BLACK	1	1	265,80
145-50544	5207227304101	107,1	180	4000	3000x65x45mm	3,9kg	BLACK	1	1	265,80
145-50545	5207227304118	107,1	180	3000	3000x65x45mm	3,9kg	BLACK	1	1	265,80

ΓΡΑΜΜΙΚΑ ΕΞΩΤΕΡΙΚΑ ΦΩΤΙΣΤΙΚΑ LED LINEAR SURFACE LIGHT FIXTURE LED



130-180Lm/W

Volt: **220-240V 50/60Hz** • LED Type: **SMD2835**

Γωνία Δέσμης Φωτός / Beam Angle: **110°**

Ενεργειακή Κλάση / Energy Class: **E (130Lm/W) / C (180Lm/W)**

Start Time: **0,5sec** • PF > **0,90** • CRI > **80**

Υλικό / Material: **Αλουμίνιο & Πλαστικό / Aluminium & Plastic**

Σύνδεση / Connection: **Καλώδιο / Wire**



ΕΠΙΛΟΓΗ / CHOICE



ΧΡΩΜΑ ΤΗΣ ΕΠΙΛΟΓΗΣ ΣΑΣ

COLOR OF YOUR CHOICE

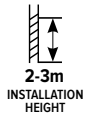

CODE	BARCODE	WATT	Lm/W	KELVIN	DIMENSIONS	WEIGHT	COLOR	PACKING	MOQ	PRICE (€)
145-50700	5207227304125	40	130	6500	1000x80x70mm	2,06kg	WHITE	1	1	102,40
145-50701	5207227304132	40	130	4000	1000x80x70mm	2,06kg	WHITE	1	1	102,40
145-50702	5207227304149	40	130	3000	1000x80x70mm	2,06kg	WHITE	1	1	102,40
145-50703	5207227304156	40	130	6500	1000x80x70mm	2,06kg	BLACK	1	1	102,40
145-50704	5207227304163	40	130	4000	1000x80x70mm	2,06kg	BLACK	1	1	102,40
145-50705	5207227304170	40	130	3000	1000x80x70mm	2,06kg	BLACK	1	1	102,40

CODE	BARCODE	WATT	Lm/W	KELVIN	DIMENSIONS	WEIGHT	COLOR	PACKING	MOQ	PRICE (€)
145-50710	5207227304187	48	130	6500	1200x80x70mm	2,47kg	WHITE	1	1	119,60
145-50711	5207227304194	48	130	4000	1200x80x70mm	2,47kg	WHITE	1	1	119,60
145-50712	5207227304200	48	130	3000	1200x80x70mm	2,47kg	WHITE	1	1	119,60
145-50713	5207227304217	48	130	6500	1200x80x70mm	2,47kg	BLACK	1	1	119,60
145-50714	5207227304224	48	130	4000	1200x80x70mm	2,47kg	BLACK	1	1	119,60
145-50715	5207227304231	48	130	3000	1200x80x70mm	2,47kg	BLACK	1	1	119,60

CODE	BARCODE	WATT	Lm/W	KELVIN	DIMENSIONS	WEIGHT	COLOR	PACKING	MOQ	PRICE (€)
145-50720	5207227304248	60	130	6500	1500x80x70mm	3,09kg	WHITE	1	1	143,20
145-50721	5207227304255	60	130	4000	1500x80x70mm	3,09kg	WHITE	1	1	143,20
145-50722	5207227304262	60	130	3000	1500x80x70mm	3,09kg	WHITE	1	1	143,20
145-50723	5207227304279	60	130	6500	1500x80x70mm	3,09kg	BLACK	1	1	143,20
145-50724	5207227304286	60	130	4000	1500x80x70mm	3,09kg	BLACK	1	1	143,20
145-50725	5207227304293	60	130	3000	1500x80x70mm	3,09kg	BLACK	1	1	143,20

CODE	BARCODE	WATT	Lm/W	KELVIN	DIMENSIONS	WEIGHT	COLOR	PACKING	MOQ	PRICE (€)
145-50730	5207227304309	80	130	6500	2000x80x70mm	4,12kg	WHITE	1	1	184,20
145-50731	5207227304316	80	130	4000	2000x80x70mm	4,12kg	WHITE	1	1	184,20
145-50732	5207227304323	80	130	3000	2000x80x70mm	4,12kg	WHITE	1	1	184,20
145-50733	5207227304330	80	130	6500	2000x80x70mm	4,12kg	BLACK	1	1	184,20
145-50734	5207227304347	80	130	4000	2000x80x70mm	4,12kg	BLACK	1	1	184,20
145-50735	5207227304354	80	130	3000	2000x80x70mm	4,12kg	BLACK	1	1	184,20

CODE	BARCODE	WATT	Lm/W	KELVIN	DIMENSIONS	WEIGHT	COLOR	PACKING	MOQ	PRICE (€)
145-50740	5207227304361	120	130	6500	3000x80x70mm	6,18kg	WHITE	1	1	282,20
145-50741	5207227304378	120	130	4000	3000x80x70mm	6,18kg	WHITE	1	1	282,20
145-50742	5207227304385	120	130	3000	3000x80x70mm	6,18kg	WHITE	1	1	282,20
145-50743	5207227304392	120	130	6500	3000x80x70mm	6,18kg	BLACK	1	1	282,20
145-50744	5207227304408	120	130	4000	3000x80x70mm	6,18kg	BLACK	1	1	282,20
145-50745	5207227304415	120	130	3000	3000x80x70mm	6,18kg	BLACK	1	1	282,20



CODE	BARCODE	WATT	Lm/W	KELVIN	DIMENSIONS	WEIGHT	COLOR	PACKING	MOQ	PRICE (€)
145-50800	5207227304422	35,7	180	6500	1000x80x70mm	2,06kg	WHITE	1	1	121,60
145-50801	5207227304439	35,7	180	4000	1000x80x70mm	2,06kg	WHITE	1	1	121,60
145-50802	5207227304446	35,7	180	3000	1000x80x70mm	2,06kg	WHITE	1	1	121,60
145-50803	5207227304453	35,7	180	6500	1000x80x70mm	2,06kg	BLACK	1	1	121,60
145-50804	5207227304460	35,7	180	4000	1000x80x70mm	2,06kg	BLACK	1	1	121,60
145-50805	5207227304477	35,7	180	3000	1000x80x70mm	2,06kg	BLACK	1	1	121,60

CODE	BARCODE	WATT	Lm/W	KELVIN	DIMENSIONS	WEIGHT	COLOR	PACKING	MOQ	PRICE (€)
145-50810	5207227304484	43,2	180	6500	1200x80x70mm	2,47kg	WHITE	1	1	141,20
145-50811	5207227304491	43,2	180	4000	1200x80x70mm	2,47kg	WHITE	1	1	141,20
145-50812	5207227304507	43,2	180	3000	1200x80x70mm	2,47kg	WHITE	1	1	141,20
145-50813	5207227304514	43,2	180	6500	1200x80x70mm	2,47kg	BLACK	1	1	141,20
145-50814	5207227304521	43,2	180	4000	1200x80x70mm	2,47kg	BLACK	1	1	141,20
145-50815	5207227304538	43,2	180	3000	1200x80x70mm	2,47kg	BLACK	1	1	141,20

CODE	BARCODE	WATT	Lm/W	KELVIN	DIMENSIONS	WEIGHT	COLOR	PACKING	MOQ	PRICE (€)
145-50820	5207227304545	57,2	180	6500	1500x80x70mm	3,09kg	WHITE	1	1	164,85
145-50821	5207227304552	57,2	180	4000	1500x80x70mm	3,09kg	WHITE	1	1	164,85
145-50822	5207227304569	57,2	180	3000	1500x80x70mm	3,09kg	WHITE	1	1	164,85
145-50823	5207227304576	57,2	180	6500	1500x80x70mm	3,09kg	BLACK	1	1	164,85
145-50824	5207227304583	57,2	180	4000	1500x80x70mm	3,09kg	BLACK	1	1	164,85
145-50825	5207227304590	57,2	180	3000	1500x80x70mm	3,09kg	BLACK	1	1	164,85

CODE	BARCODE	WATT	Lm/W	KELVIN	DIMENSIONS	WEIGHT	COLOR	PACKING	MOQ	PRICE (€)
145-50830	5207227304606	71,4	180	6500	2000x80x70mm	4,12kg	WHITE	1	1	208,60
145-50831	5207227304613	71,4	180	4000	2000x80x70mm	4,12kg	WHITE	1	1	208,60
145-50832	5207227304620	71,4	180	3000	2000x80x70mm	4,12kg	WHITE	1	1	208,60
145-50833	5207227304637	71,4	180	6500	2000x80x70mm	4,12kg	BLACK	1	1	208,60
145-50834	5207227304644	71,4	180	4000	2000x80x70mm	4,12kg	BLACK	1	1	208,60
145-50835	5207227304651	71,4	180	3000	2000x80x70mm	4,12kg	BLACK	1	1	208,60

CODE	BARCODE	WATT	Lm/W	KELVIN	DIMENSIONS	WEIGHT	COLOR	PACKING	MOQ	PRICE (€)
145-50840	5207227304668	107,1	180	6500	3000x80x70mm	6,18kg	WHITE	1	1	321,40
145-50841	5207227304675	107,1	180	4000	3000x80x70mm	6,18kg	WHITE	1	1	321,40
145-50842	5207227304682	107,1	180	3000	3000x80x70mm	6,18kg	WHITE	1	1	321,40
145-50843	5207227304699	107,1	180	6500	3000x80x70mm	6,18kg	BLACK	1	1	321,40
145-50844	5207227304705	107,1	180	4000	3000x80x70mm	6,18kg	BLACK	1	1	321,40
145-50845	5207227304712	107,1	180	3000	3000x80x70mm	6,18kg	BLACK	1	1	321,40

ΑΞΕΣΟΥΑΡ ACCESSORIES

ΝΤΙΖΑ ΓΙΑ ΠΡΟΦΙΛ ΛΟΥΜΙΝΙΟΥ 2 ΤΕΜ

HANGING SET 2 PCS



CODE	BARCODE	PACKING	MOQ	PRICE (€)
145-79800	5207227259029	1/1	1	5,32

CLIPS ΓΥΨΟΣΑΝΙΔΑΣ ΓΙΑ ΠΡΟΦΙΛ ΑΛΟΥΜΙΝΙΟΥ

PLASTERBOARD CLIPS FOR ALUMINUM PROFILE



Υλικό / Material: **Μέταλλο / Metal**

CODE	BARCODE	PACKING	MOQ	PRICE (€)
145-79809	5207227334252	1/1	1	3,20

ΓΩΝΙΑ ΕΞΩΤΕΡΙΚΗ 90° & ΕΣΩΤΕΡΙΚΗ 90° & ΣΥΝΔΕΣΜΟΣ ΕΥΘΕΙΑΣ

EXTERIOR & INTERIOR CORNER 90° METAL JOINER & DIRECT LINK 180° METAL JOINER

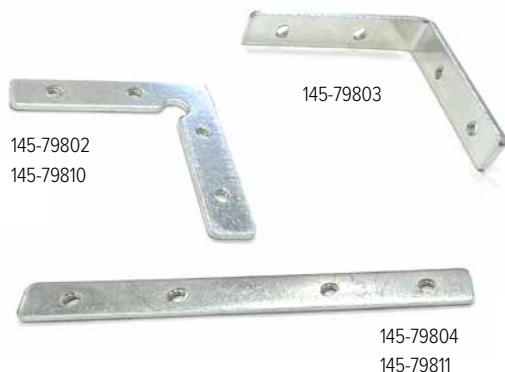

Υλικό / Material: **Μέταλλο / Metal**

CODE	BARCODE	PACKING	MOQ	PRICE (€)
145-79802	5207227259043	1/1	1	0,93
145-79803	5207227259050	1/1	1	0,93
145-79804	5207227259067	1/1	1	0,71
145-79810	5207227334269	1/1	1	K.E. *
145-79811	5207227334276	1/1	1	K.E. *

* ΤΙΜΗ ΚΑΤΟΠΙΝ ΕΡΩΤΗΣΗΣ / PRICE AFTER REQUEST

ΤΑΠΑ ΜΕΤΑΛΛΙΚΗ ΓΙΑ ΧΩΝΕΥΤΑ ΦΩΤΙΣΤΙΚΑ

METAL END CAP FOR RECESSED LIGHT FIXTURES



Υλικό / Material: **Μέταλλο / Metal**

CODE	BARCODE	PACKING	MOQ	PRICE (€)
145-79812	5207227334245	1/1	1	2,43

ΒΑΣΗ ΟΡΟΦΗΣ ΜΕΤΑΛΛΙΚΗ

METAL CEILING BASE



Υλικό / Material: **Μέταλλο / Metal**

CODE	BARCODE	PACKING	MOQ	PRICE (€)
145-79801	5207227259036	1/1	1	4,41

ΤΑΠΑ ΠΛΑΣΤΙΚΗ ΓΙΑ ΕΞΩΤΕΡΙΚΑ ΦΩΤΙΣΤΙΚΑ

PLASTIC END CAP FOR SURFACE MOUNTED LIGHT FIXTURES

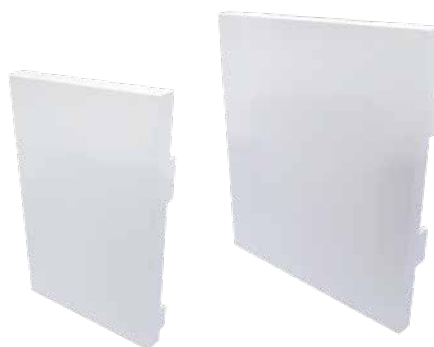

65x45mm

Υλικό / Material: **Πλαστικό / Plastic**

CODE	BARCODE	COLOR	PACKING	MOQ	PRICE (€)
145-79805	5207227259074	WHITE	1/1	1	1,11
145-79807	5207227259098	BLACK	1/1	1	1,11

80x70mm

Υλικό / Material: **Πλαστικό / Plastic**

CODE	BARCODE	COLOR	PACKING	MOQ	PRICE (€)
145-79806	5207227259081	WHITE	1/1	1	1,77
145-79808	5207227259104	BLACK	1/1	1	1,77

Σποτ LED Ράγας & Μαγνητικής Ράγας

Track Spot LED Lights
& Magnetic Track



ΣΠΟΤ ΜΑΓΝΗΤΙΚΗΣ ΡΑΓΑΣ ULTRA SLIM 3CCT ΜΕ TRIAC MAGNETIC TRACK SPOT ULTRA SLIM 3CCT WITH TRIAC

PRO
SERIES

3
CCT



114,5x94,7xØ31mm

Volt: **40V DC** • LED Type: **COB**

Ένταση ρεύματος / Amperage: **130mA**

Γωνία Δέσμης Φωτός / Beam Angle: **24°**

Ενεργειακή Κλάση / Energy Class: **G**

Start Time: **0,5sec** • PF > **0,50** • CRI > **90**

Υλικό / Material: **Αλουμίνιο & Πλαστικό / Aluminium & Plastic**

Σύνδεση / Connection: **Copper spot connector**

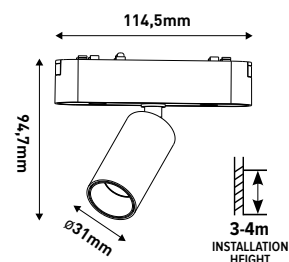

CODE	BARCODE	WATT	KELVIN	LUMEN/WATT	COLOR	PACKING	MOQ	PRICE (€)
145-59500	5207227286759	5	3CCT 2700 / 4300 / 6000K	80	BLACK	1/30	1	29,65
145-59501	5207227286766	5	3CCT 2700 / 4300 / 6000K	80	WHITE	1/30	1	29,65
145-59502	5207227286773	5	3CCT 2700 / 4300 / 6000K	80	BRONZE	1/30	1	31,60

PRO
SERIES

3
CCT



114,5x94,7xØ31mm

Volt: **40V DC** • LED Type: **COB**

Ένταση ρεύματος / Amperage: **250mA**

Γωνία Δέσμης Φωτός / Beam Angle: **24°**

Ενεργειακή Κλάση / Energy Class: **G**

Start Time: **0,5sec** • PF > **0,50** • CRI > **90**

Υλικό / Material: **Αλουμίνιο & Πλαστικό / Aluminium & Plastic**

Σύνδεση / Connection: **Copper spot connector**

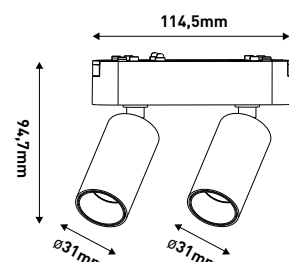

CODE	BARCODE	WATT	KELVIN	LUMEN/WATT	COLOR	PACKING	MOQ	PRICE (€)
145-59503	5207227286780	10	3CCT 2700 / 4300 / 6000K	80	BLACK	1/30	1	49,60

ΣΠΟΤ ΜΑΓΝΗΤΙΚΗΣ ΡΑΓΑΣ ULTRA SLIM 3CCT ΜΕ TRIAC MAGNETIC TRACK SPOT ULTRA SLIM 3CCT WITH TRIAC

PRO
SERIES

3
CCT



114,5x144,8xØ31mm

Volt: **40V DC** • LED Type: **COB**

Ένταση ρεύματος / Amperage: **170mA**

Γωνία Δέσμης Φωτός / Beam Angle: **24°**

Ενεργειακή Κλάση / Energy Class: **G**

Start Time: **0,5sec** • PF > **0,50** • CRI > **90**

Υλικό / Material: **Αλουμίνιο & Πλαστικό / Aluminium & Plastic**

Σύνδεση / Connection: **Copper spot connector**

-20 | +45 °C

**TRIAC
DIMMING**

0,215kg

30.000h

**ON
OFF**
15.000

IP20

**3
YEARS
WARRANTY**

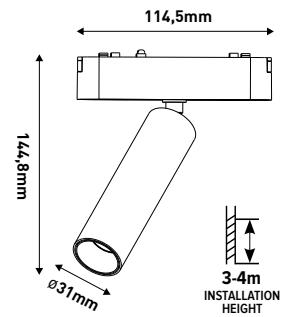

CODE	BARCODE	WATT	KELVIN	LUMEN/WATT	COLOR	PACKING	MOQ	PRICE (€)
145-59504	5207227286797	7	3CCT 2700 / 4300 / 6000K	80	BLACK	1/30	1	32,85
145-59505	5207227286803	7	3CCT 2700 / 4300 / 6000K	80	WHITE	1/30	1	32,85
145-59506	5207227286810	7	3CCT 2700 / 4300 / 6000K	80	BRONZE	1/30	1	34,80

PRO
SERIES

3
CCT



114,5x144,8xØ31mm

Volt: **40V DC** • LED Type: **COB**

Ένταση ρεύματος / Amperage: **350mA**

Γωνία Δέσμης Φωτός / Beam Angle: **24°**

Ενεργειακή Κλάση / Energy Class: **G**

Start Time: **0,5sec** • PF > **0,50** • CRI > **90**

Υλικό / Material: **Αλουμίνιο & Πλαστικό / Aluminium & Plastic**

Σύνδεση / Connection: **Copper spot connector**

-20 | +45 °C

**TRIAC
DIMMING**

0,331kg

30.000h

**ON
OFF**
15.000

IP20

**3
YEARS
WARRANTY**

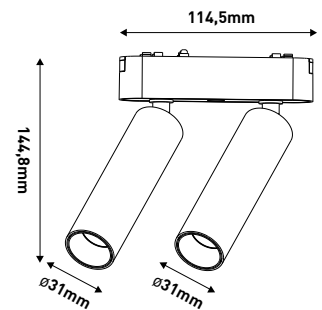

CODE	BARCODE	WATT	KELVIN	LUMEN/WATT	COLOR	PACKING	MOQ	PRICE (€)
145-59507	5207227286827	14	3CCT 2700 / 4300 / 6000K	80	BLACK	1/30	1	55,90

ΣΠΟΤ ΜΑΓΝΗΤΙΚΗΣ ΡΑΓΑΣ ULTRA SLIM 3CCT ME TRIAC MAGNETIC TRACK SPOT ULTRA SLIM 3CCT WITH TRIAC



114,5x170,2xØ45mm

Volt: **40V DC** • LED Type: **COB**

Ένταση ρεύματος / Amperage: **400mA**

Γωνία Δέσμης Φωτός / Beam Angle: **36°**

Ενεργειακή Κλάση / Energy Class: **G**

Start Time: **0,5sec** • PF > **0,50** • CRI > **90**

Υλικό / Material: **Αλουμίνιο & Πλαστικό / Aluminium & Plastic**

Σύνδεση / Connection: **Copper spot connector**

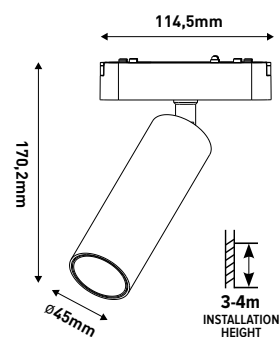

CODE	BARCODE	WATT	KELVIN	LUMEN/WATT	COLOR	PACKING	MOQ	PRICE (€)
145-59508	5207227286834	15	3CCT 2700 / 4300 / 6000K	80	BLACK	1/30	1	42,80
145-59509	5207227286841	15	3CCT 2700 / 4300 / 6000K	80	WHITE	1/30	1	42,80
145-59510	5207227286858	15	3CCT 2700 / 4300 / 6000K	80	BRONZE	1/30	1	45,60

ΣΦΑΙΡΙΚΟ ΦΩΤΙΣΤΙΚΟ ΜΑΓΝΗΤΙΚΗΣ ΡΑΓΑΣ ULTRA SLIM 3CCT ME TRIAC SPHERICAL LIGHTING FIXTURE FOR MAGNETIC TRACK ULTRA SLIM 10W 3CCT WITH TRIAC



114,5x118xØ100mm

Volt: **40V DC** • LED Type: **COB**

Ένταση ρεύματος / Amperage: **250mA**

Γωνία Δέσμης Φωτός / Beam Angle: **128°**

Ενεργειακή Κλάση / Energy Class: **G**

Start Time: **0,5sec** • PF > **0,50** • CRI > **90**

Υλικό / Material: **Αλουμίνιο & Πλαστικό / Aluminium & Plastic**

Σύνδεση / Connection: **Copper spot connector**

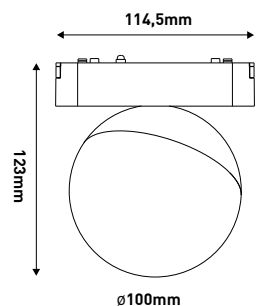

CODE	BARCODE	WATT	KELVIN	LUMEN/WATT	COLOR	PACKING	MOQ	PRICE (€)
145-59511	5207227286865	10	3CCT 2700 / 4300 / 6000K	80	BLACK	1/20	1	76,50

ΣΠΟΤ ΜΑΓΝΗΤΙΚΗΣ ΡΑΓΑΣ ULTRA SLIM 3CCT ME TRIAC MAGNETIC TRACK SPOT ULTRA SLIM 3CCT WITH TRIAC



114,5x134xØ42mm

Volt: **40V DC** • LED Type: **COB**

Ένταση ρεύματος / Amperage: **200mA**

Γωνία Δέσμης Φωτός / Beam Angle: **36°**

Ενεργειακή Κλάση / Energy Class: **G**

Start Time: **0,5sec** • PF > **0,50** • CRI > **90**

Υλικό / Material: **Αλουμίνιο & Πλαστικό / Aluminium & Plastic**

Σύνδεση / Connection: **Copper spot connector**

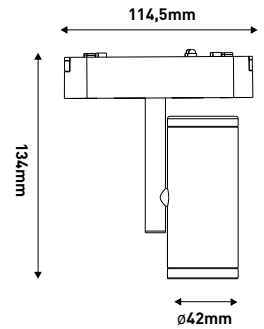

CODE	BARCODE	WATT	KELVIN	LUMEN/WATT	COLOR	PACKING	MOQ	PRICE (€)
145-59512	5207227286872	8	3CCT 2700 / 4300 / 6000K	80	BLACK	1/30	1	46,60



114,5x243xØ42mm

Volt: **40V DC** • LED Type: **COB**

Ένταση ρεύματος / Amperage: **400mA**

Γωνία Δέσμης Φωτός / Beam Angle: **36°**

Ενεργειακή Κλάση / Energy Class: **G**

Start Time: **0,5sec** • PF > **0,50** • CRI > **90**

Υλικό / Material: **Αλουμίνιο & Πλαστικό / Aluminium & Plastic**

Σύνδεση / Connection: **Copper spot connector**

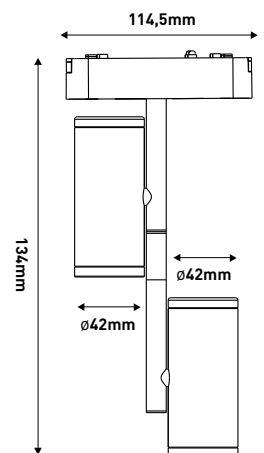
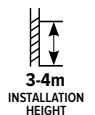

CODE	BARCODE	WATT	KELVIN	LUMEN/WATT	COLOR	PACKING	MOQ	PRICE (€)
145-59513	5207227286889	16	3CCT 2700 / 4300 / 6000K	80	BLACK	1/30	1	78,90

ΚΡΕΜΑΣΤΟ ΦΩΤΙΣΤΙΚΟ ΜΑΥΡΟ ΜΑΓΝΗΤΙΚΗΣ ΡΑΓΑΣ ULTRA SLIM 3CCT ME TRIAC

HANGING LIGHTING FIXTURE FOR MAGNETIC TRACK ULTRA SLIM 3CCT WITH TRIAC



114,5x1000x32mm

Volt: **40V DC** • LED Type: **COB**

Ένταση ρεύματος / Amperage: **170mA**

Γωνία Δέσμης Φωτός / Beam Angle: **24°**

Ενεργειακή Κλάση / Energy Class: **G**

Start Time: **0,5sec** • PF > **0,50** • CRI > **90**

Υλικό / Material: **Αλουμίνιο & Πλαστικό / Aluminium & Plastic**

Σύνδεση / Connection: **Copper spot connector**

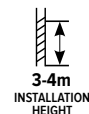

CODE	BARCODE	WATT	KELVIN	LUMEN/WATT	COLOR	PACKING	MOQ	PRICE (€)
145-59514	5207227286896	7	3CCT 2700 / 4300 / 6000K	80	BLACK	1/30	1	43,25
145-59515	5207227286902	7	3CCT 2700 / 4300 / 6000K	80	WHITE	1/30	1	43,25

ΣΠΟΤ ΜΑΓΝΗΤΙΚΗΣ ΡΑΓΑΣ ULTRA SLIM 3CCT ME TRIAC

MAGNETIC TRACK SPOT ULTRA SLIM 3CCT WITH TRIAC



Ø50x70mm

Volt: **40V DC** • LED Type: **COB**

Ένταση ρεύματος / Amperage: **200mA**

Γωνία Δέσμης Φωτός / Beam Angle: **36°**

Ενεργειακή Κλάση / Energy Class: **G**

Start Time: **0,5sec** • PF > **0,50** • CRI > **90**

Υλικό / Material: **Αλουμίνιο & Πλαστικό / Aluminium & Plastic**

Σύνδεση / Connection: **Copper spot connector**

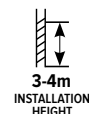

CODE	BARCODE	WATT	KELVIN	LUMEN/WATT	COLOR	PACKING	MOQ	PRICE (€)
145-59516	5207227286919	8	3CCT 2700 / 4300 / 6000K	80	BLACK	1/30	1	29,85
145-59517	5207227286926	8	3CCT 2700 / 4300 / 6000K	80	WHITE	1/30	1	29,85

ΣΠΟΤ ΜΑΓΝΗΤΙΚΗΣ ΡΑΓΑΣ ULTRA SLIM 3CCT ME TRIAC MAGNETIC TRACK SPOT ULTRA SLIM 3CCT WITH TRIAC



114,5x142x105mm

Volt: **40V DC** • LED Type: **COB**

Ένταση ρεύματος / Amperage: **400mA**

Γωνία Δέσμης Φωτός / Beam Angle: **36°**

Ενεργειακή Κλάση / Energy Class: **G**

Start Time: **0,5sec** • PF > **0,50** • CRI > **90**

Υλικό / Material: **Αλουμίνιο & Πλαστικό / Aluminium & Plastic**

Σύνδεση / Connection: **Copper spot connector**

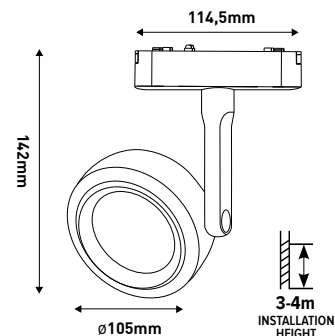

CODE	BARCODE	WATT	KELVIN	LUMEN/WATT	COLOR	PACKING	MOQ	PRICE (€)
145-59518	5207227286933	15	3CCT 2700 / 4300 / 6000K	80	BLACK	1/30	1	74,75
145-59519	5207227286940	15	3CCT 2700 / 4300 / 6000K	80	WHITE	1/30	1	74,75

ΦΩΤΙΣΤΙΚΟ ΚΡΕΜΑΣΤΟ ΜΑΓΝΗΤΙΚΗΣ ΡΑΓΑΣ ULTRA SLIM 3CCT ME TRIAC LIGHTING FUXTURE FOR MAGNETIC TRACK ULTRA SLIM 3CCT WITH TRIAC



114,5x22x1070mm

Volt: **40V DC** • LED Type: **SMD2835**

Ένταση ρεύματος / Amperage: **450mA**

Γωνία Δέσμης Φωτός / Beam Angle: **360°**

Ενεργειακή Κλάση / Energy Class: **G**

Start Time: **0,5sec** • PF > **0,50** • CRI > **90**

Υλικό / Material: **Αλουμίνιο & Πλαστικό / Aluminium & Plastic**

Σύνδεση / Connection: **Copper spot connector**

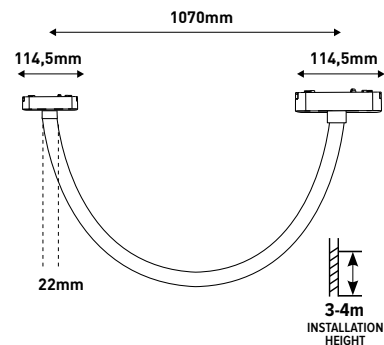

CODE	BARCODE	WATT	KELVIN	LUMEN/WATT	COLOR	PACKING	MOQ	PRICE (€)
145-59520	5207227286957	18	3CCT 2700 / 4300 / 6000K	70	WHITE	1/10	1	62,90

ΦΩΤΙΣΤΙΚΟ ΜΑΓΝΗΤΙΚΗΣ ΡΑΓΑΣ ULTRA SLIM 3CCT ME TRIAC LIGHTING FIXTURE FOR MAGNETIC TRACK ULTRA SLIM 3CCT WITH TRIAC



114,5x25x27,5mm

Volt: **40V DC** • LED Type: **SMD2835**
 Ένταση ρεύματος / Amperage: **150mA**
 Γωνία Δέσμης Φωτός / Beam Angle: **100°**
 Ενεργειακή Κλάση / Energy Class: **G**
 Start Time: **0,5sec** • PF > **0,50** • CRI > **90**
 Υλικό / Material: **Αλουμίνιο & Πλαστικό / Aluminium & Plastic**
 Σύνδεση / Connection: **Copper spot connector**

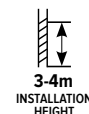
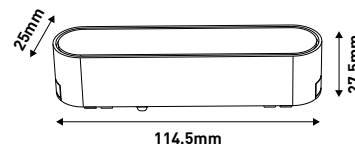

CODE	BARCODE	WATT	KELVIN	LUMEN/WATT	COLOR	PACKING	MOQ	PRICE (€)
145-59522	5207227286964	6	3CCT 2700 / 4300 / 6000K	50	BLACK	1/50	1	19,25
145-59529	5207227287039	6	3CCT 2700 / 4300 / 6000K	50	WHITE	1/50	1	19,25



222x25x27,5mm

Volt: **40V DC** • LED Type: **SMD2835**
 Ένταση ρεύματος / Amperage: **300mA**
 Γωνία Δέσμης Φωτός / Beam Angle: **100°**
 Ενεργειακή Κλάση / Energy Class: **G**
 Start Time: **0,5sec** • PF > **0,50** • CRI > **90**
 Υλικό / Material: **Αλουμίνιο & Πλαστικό / Aluminium & Plastic**
 Σύνδεση / Connection: **Copper spot connector**

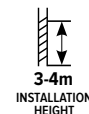
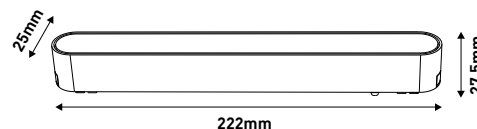

CODE	BARCODE	WATT	KELVIN	LUMEN/WATT	COLOR	PACKING	MOQ	PRICE (€)
145-59523	5207227286971	12	3CCT 2700 / 4300 / 6000K	50	BLACK	1/50	1	25,60
145-59530	5207227287046	12	3CCT 2700 / 4300 / 6000K	50	WHITE	1/50	1	25,60

ΦΩΤΙΣΤΙΚΟ ΜΑΓΝΗΤΙΚΗΣ ΡΑΓΑΣ ULTRA SLIM 3CCT ME TRIAC

LIGHTING FIXTURE FOR MAGNETIC TRACK ULTRA SLIM 3CCT WITH TRIAC



330,3x25x27,5mm

Volt: **40V DC** • LED Type: **SMD2835**

Ένταση ρεύματος / Amperage: **400mA**

Γωνία Δέσμης Φωτός / Beam Angle: **100°**

Ενεργειακή Κλάση / Energy Class: **G**

Start Time: **0,5sec** • PF > **0,50** • CRI > **90**

Υλικό / Material: **Αλουμίνιο & Πλαστικό / Aluminium & Plastic**

Σύνδεση / Connection: **Copper spot connector**

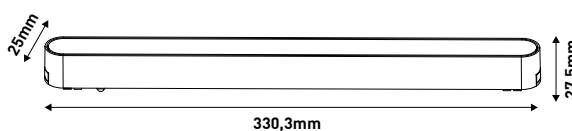

CODE	BARCODE	WATT	KELVIN	LUMEN/WATT	COLOR	PACKING	MOQ	PRICE (€)	
145-59524	5207227286988	16	3CCT	2700 / 4300 / 6000K	50	BLACK	1/50	1	34,85



114,5x25x27,5mm

Volt: **40V DC** • LED Type: **SMD3030**

Ένταση ρεύματος / Amperage: **150mA**

Γωνία Δέσμης Φωτός / Beam Angle: **36°**

Ενεργειακή Κλάση / Energy Class: **G**

Start Time: **0,5sec** • PF > **0,50** • CRI > **90**

Υλικό / Material: **Αλουμίνιο & Πλαστικό / Aluminium & Plastic**

Σύνδεση / Connection: **Copper spot connector**

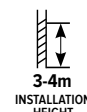
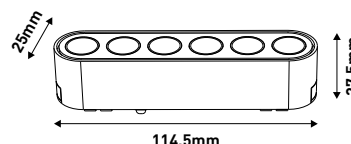

CODE	BARCODE	WATT	KELVIN	LUMEN/WATT	COLOR	PACKING	MOQ	PRICE (€)	
145-59525	5207227286995	6	3CCT	2700 / 4300 / 6000K	80	BLACK	1/50	1	20,65
145-59531	5207227287053	6	3CCT	2700 / 4300 / 6000K	80	WHITE	1/50	1	20,65

ΦΩΤΙΣΤΙΚΟ ΜΑΓΝΗΤΙΚΗΣ ΡΑΓΑΣ ULTRA SLIM 3CCT ME TRIAC LIGHTING FIXTURE FOR MAGNETIC TRACK ULTRA SLIM 3CCT WITH TRIAC



222x25x27,5mm

Volt: **40V DC** • LED Type: **SMD3030**

Ένταση ρεύματος / Amperage: **300mA**

Γωνία Δέσμης Φωτός / Beam Angle: **36°**

Ενεργειακή Κλάση / Energy Class: **G**

Start Time: **0,5sec** • PF > **0,50** • CRI > **90**

Υλικό / Material: **Αλουμίνιο & Πλαστικό / Aluminium & Plastic**

Σύνδεση / Connection: **Copper spot connector**

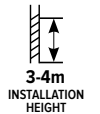
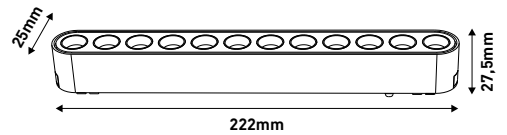

CODE	BARCODE	WATT	KELVIN	LUMEN/WATT	COLOR	PACKING	MOQ	PRICE (€)
145-59526	5207227287008	12	3CCT 2700 / 4300 / 6000K	80	BLACK	1/50	1	27,85
145-59532	5207227287060	12	3CCT 2700 / 4300 / 6000K	80	WHITE	1/50	1	27,85



330,3x25x27,5mm

Volt: **40V DC** • LED Type: **SMD3030**

Ένταση ρεύματος / Amperage: **400mA**

Γωνία Δέσμης Φωτός / Beam Angle: **36°**

Ενεργειακή Κλάση / Energy Class: **G**

Start Time: **0,5sec** • PF > **0,50** • CRI > **90**

Υλικό / Material: **Αλουμίνιο & Πλαστικό / Aluminium & Plastic**

Σύνδεση / Connection: **Copper spot connector**

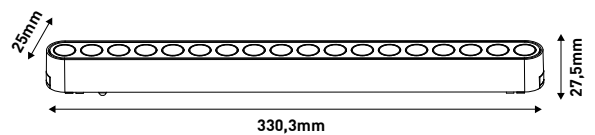

CODE	BARCODE	WATT	KELVIN	LUMEN/WATT	COLOR	PACKING	MOQ	PRICE (€)
145-59527	5207227287015	16	3CCT 2700 / 4300 / 6000K	80	BLACK	1/50	1	42,25

ΦΩΤΙΣΤΙΚΟ ΜΑΓΝΗΤΙΚΗΣ ΡΑΓΑΣ ULTRA SLIM 3CCT ME TRIAC LIGHTING FIXTURE FOR MAGNETIC TRACK ULTRA SLIM 3CCT WITH TRIAC



222x25x27,5mm

Volt: **40V DC** • LED Type: **SMD2835**

Ένταση ρεύματος / Amperage: **300mA**

Γωνία Δέσμης Φωτός / Beam Angle: **36°**

Ενεργειακή Κλάση / Energy Class: **G**

Start Time: **0,5sec** • PF > **0,50** • CRI > **90**

Υλικό / Material: **Αλουμίνιο & Πλαστικό / Aluminium & Plastic**

Σύνδεση / Connection: **Copper spot connector**

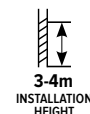
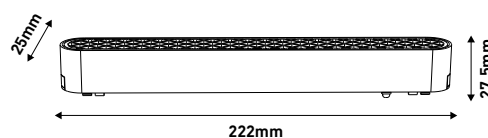

- 20 | +45 °C**
- TRIAC DIMMING**
- 0,27kg**
- 30.000h**
- ON OFF 15.000**
- IP20**
- 3 YEARS WARRANTY**

CODE	BARCODE	WATT	KELVIN	LUMEN/WATT	COLOR	PACKING	MOQ	PRICE (€)
145-59528	5207227287022	12	3CCT 2700 / 4300 / 6000K	45	BLACK	50	1	76,60
145-59533	5207227287077	12	3CCT 2700 / 4300 / 6000K	45	WHITE	50	1	76,60

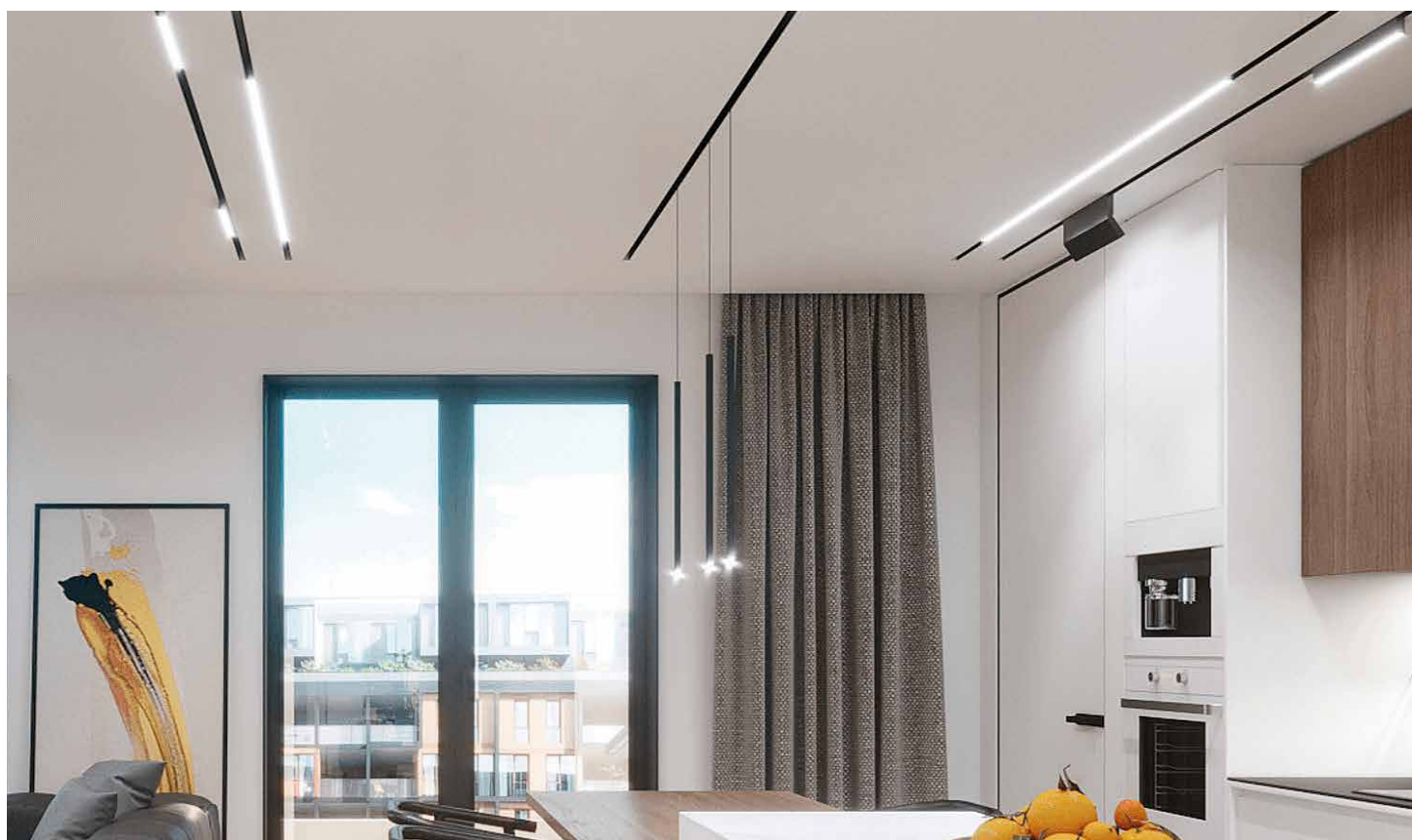

ΜΑΓΝΗΤΙΚΗ ΡΑΓΑ ULTRA SLIM & ΑΞΕΣΟΥΑΡ MAGNETIC TRACK ULTRA SLIM & ACCESSORIES

ΜΑΓΝΗΤΙΚΗ ΡΑΓΑ ULTRA SLIM

MAGNETIC TRACK ULTRA SLIM

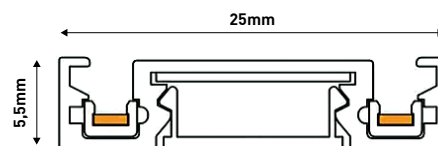

Υλικό / Material: **Αλουμίνιο / Aluminium**

V 220-240V **-20 | +45 °C** **IP20** **3 YEARS WARRANTY**

CODE	BARCODE	DIMENSIONS	WEIGHT	COLOR	PACKING	MOQ	PRICE (€)
145-59561	5207227287251	1000x25x5,5mm	0,253kg	WHITE	1/10	1	20,60
145-59562	5207227287268	1500x25x5,5mm	0,384kg	WHITE	1/10	1	26,85
145-59550	5207227287145	1000x25x5,5mm	0,253kg	BLACK	1/10	1	13,85
145-59551	5207227287152	1500x25x5,5mm	0,384kg	BLACK	1/10	1	20,60
145-59552	5207227287169	2000x25x5,5mm	0,512kg	BLACK	1/10	1	26,85

ΤΑΠΑ

END CUP



Υλικό / Material: **PVC / PVC**

0,001kg **-20 | +45 °C** **IP20** **3 YEARS WARRANTY**

CODE	BARCODE	COLOR	PACKING	MOQ	PRICE (€)
145-59563	5207227287275	WHITE	1/10	1	1,35
145-59553	5207227263798	BLACK	1/20	1	1,35

ΣΥΝΔΕΣΜΟΣ ΓΩΝΙΑΣ 90°

CONJUNCTION ANGLE 90°

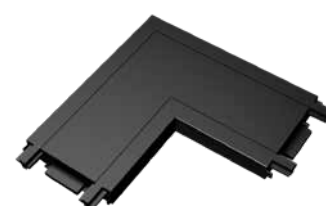

Υλικό / Material: **PVC / PVC**

0,001kg **V** 220-240V **-20 | +45 °C** **IP20** **5 YEARS WARRANTY**

CODE	BARCODE	COLOR	PACKING	MOQ	PRICE (€)
145-59564	5207227287282	WHITE	1/20	1	5,85
145-59554	5207227287183	BLACK	1/20	1	5,85

ΣΥΝΔΕΣΜΟΣ ΤΥΠΟΥ "T"

CONJUNCTION TYPE "T"

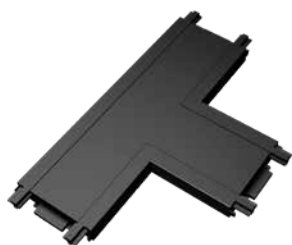

Υλικό / Material: **PVC / PVC**

0,026kg
 220-240V
 -20 | +45 °C
 IP20
 3 YEARS WARRANTY

CODE	BARCODE	COLOR	PACKING	MOQ	PRICE (€)
145-59565	5207227287299	WHITE	1/20	1	7,80
145-59555	5207227287190	BLACK	1/20	1	7,80

ΣΥΝΔΕΣΜΟΣ ΤΥΠΟΥ "ΣΤΑΥΡΟΣ"

CONJUNCTION TYPE "CROSS"



Υλικό / Material: **PVC / PVC**

0,032kg
 220-240V
 -20 | +45 °C
 IP20
 3 YEARS WARRANTY

CODE	BARCODE	COLOR	PACKING	MOQ	PRICE (€)
145-59566	5207227287305	WHITE	1/20	1	9,75
145-59556	5207227287206	BLACK	1/20	1	9,75

ΣΥΝΔΕΣΜΟΣ ΚΑΘΕΤΟΣ ΤΥΠΟΥ "IN JOINED"

CONJUNCTION TYPE "IN JOINED"



Υλικό / Material: **PVC / PVC**

0,015kg
 220-240V
 -20 | +45 °C
 IP20
 3 YEARS WARRANTY

CODE	BARCODE	COLOR	PACKING	MOQ	PRICE (€)
145-59567	5207227287312	WHITE	1/20	1	6,35
145-59557	5207227287213	BLACK	1/20	1	6,35

ΣΥΝΔΕΣΜΟΣ ΚΑΘΕΤΟΣ ΤΥΠΟΥ "I JOINED"

CONJUNCTION TYPE "I JOINED"

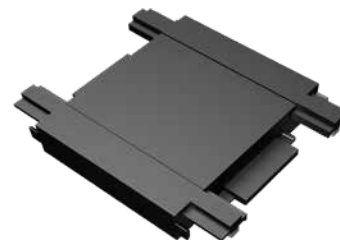

Υλικό / Material: **PVC / PVC**

0,005kg
 220-240V
 -20 | +45 °C
 IP20
 3 YEARS WARRANTY

CODE	BARCODE	COLOR	PACKING	MOQ	PRICE (€)
145-59568	5207227287329	WHITE	1/20	1	3,35
145-59558	5207227287220	BLACK	1/20	1	3,35

ΡΥΘΜΙΖΟΜΕΝΟΣ ΣΥΝΔΕΣΜΟΣ 6W

ADJUSTABLE CONNECTOR 6W



Υλικό / Material: **PVC / PVC**

0,078kg
 220-240V
 -20 | +45 °C
 IP20
 3 YEARS WARRANTY

CODE	BARCODE	COLOR	PACKING	MOQ	PRICE (€)
145-59559	5207227287237	BLACK	1/20	1	14,75

ΡΥΘΜΙΖΟΜΕΝΟΣ ΣΥΝΔΕΣΜΟΣ 12W

ADJUSTABLE CONNECTOR 12W



Υλικό / Material: **PVC / PVC**

0,135kg
 220-240V
 -20 | +45 °C
 IP20
 3 YEARS WARRANTY

CODE	BARCODE	COLOR	PACKING	MOQ	PRICE (€)
145-59560	5207227287244	BLACK	1/20	1	16,85

ΜΕΤΑΣΧΗΜΑΤΙΣΤΗΣ ΜΑΓΝΗΤΙΚΗΣ ΡΑΓΑΣ ULTRA SLIM ON-OFF DRIVER FOR MAGNETIC TRACK ULTRA SLIM ON-OFF



Υλικό / Material: **Αλουμίνιο & Πλαστικό / Aluminium & Plastic**
Σύνδεση / Connection: **Copper spot connector**

-20 | +45 °C
 30.000h
 ON OFF 15.000
 IP20
 3 YEARS WARRANTY

CODE	BARCODE	WATT	VOLT	DIMENSIONS	WEIGHT	COLOR	PACKING	MOQ	PRICE (€)
145-59540	5207227287084	100	40V DC	290x25x27,6mm	0,40kg	BLACK	1/30	1	42,20
145-59541	5207227287091	200	40V DC	290x25x27,6mm	0,42kg	BLACK	1/30	1	59,80

ΜΕΤΑΣΧΗΜΑΤΙΣΤΗΣ ΜΑΓΝΗΤΙΚΗΣ ΡΑΓΑΣ ULTRA SLIM ME TRIAC DRIVER FOR MAGNETIC TRACK ULTRA SLIM WITH TRIAC



Υλικό / Material: **Αλουμίνιο & Πλαστικό / Aluminium & Plastic**
Σύνδεση / Connection: **Copper spot connector**

-20 | +45 °C
 TRIAC DIMMING
 30.000h
ON OFF 15.000
 IP20
 3 YEARS WARRANTY

CODE	BARCODE	WATT	VOLT	DIMENSIONS	WEIGHT	COLOR	PACKING	MOQ	PRICE (€)
145-59542	5207227287107	100	40V DC	290x25x27,6mm	0,418kg	BLACK	1/30	1	77,35
145-59543	5207227287114	200	40V DC	345x25x27,6mm	0,540kg	BLACK	1/30	1	112,20

ΜΕΤΑΣΧΗΜΑΤΙΣΤΗΣ ΜΑΓΝΗΤΙΚΗΣ ΡΑΓΑΣ ULTRA SLIM ME DALI DRIVER FOR MAGNETIC TRACK ULTRA SLIM WITH DALI



Υλικό / Material: **Αλουμίνιο & Πλαστικό / Aluminium & Plastic**
Σύνδεση / Connection: **Copper spot connector**

-20 | +45 °C
 30.000h
ON OFF 15.000
 IP20
 3 YEARS WARRANTY

CODE	BARCODE	WATT	VOLT	DIMENSIONS	WEIGHT	COLOR	PACKING	MOQ	PRICE (€)
145-59544	5207227287121	100	40V DC	290x25x27,6mm	0,46kg	BLACK	1/30	1	77,85
145-59545	5207227287138	200	40V DC	345x25x27,6mm	0,545kg	BLACK	1/30	1	114,45



ΣΠΟΤ ΜΑΓΝΗΤΙΚΗΣ ΡΑΓΑΣ LED LED TRACKING SPOT LIGHT

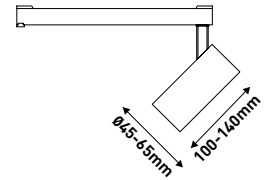

Volt: **48V DC 50/60Hz** • LED Type: **COB**
 Γωνία Δέσμης Φωτός / Beam Angle: **24°**
 Ενεργειακή Κλάση / Energy Class: **F**
 Start Time: **0,5sec** • PF > **0,50** • CRI > **90**
 Υλικό / Material: **Αλουμίνιο / Aluminium**
 Σύνδεση / Connection: **Copper spot connector**

-20 | +45 °C
 NON DIMMABLE
 FLICKER FREE
 COLOR BLACK
 25.000h
 ON OFF 15.000
 IP20
 3 YEARS WARRANTY

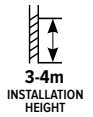

CODE	BARCODE	WATT	KELVIN	LUMEN/WATT	AMPERAGE	DIMENSIONS	WEIGHT	PACKING	MOQ	PRICE (€)
145-59930	5207227151538	12	4000	69	300mA	Ø45x100xmm	0,525kg	1/20	1	21,35
145-59931	5207227151545	18	4000	83	450mA	Ø65x140xmm	0,525kg	1/20	1	29,75
145-59934	5207227259210	12	3000	69	300mA	Ø45x100xmm	0,525kg	1/20	1	21,35
145-59935	5207227259227	18	3000	83	450mA	Ø65x140xmm	0,525kg	1/20	1	29,75

ΡΥΘΜΙΖΟΜΕΝΟ ΣΠΟΤ ΜΑΓΝΗΤΙΚΗΣ ΡΑΓΑΣ LED ADJUSTABLE LED TRACKING SPOT LIGHT

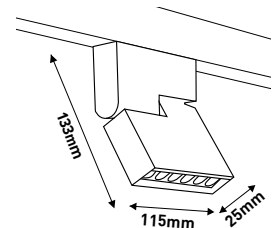

Volt: **48V DC 50/60Hz** • LED Type: **SMD3030**
 Γωνία Δέσμης Φωτός / Beam Angle: **24°**
 Ενεργειακή Κλάση / Energy Class: **G**
 Start Time: **0,5sec** • PF > **0,50** • CRI > **80**
 Υλικό / Material: **Αλουμίνιο / Aluminium**

-20 | +45 °C
 NON DIMMABLE
 FLICKER FREE
 COLOR BLACK
 25.000h
 ON OFF 15.000
 IP20
 3 YEARS WARRANTY

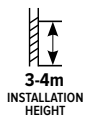

CODE	BARCODE	WATT	KELVIN	LUMEN/WATT	AMPERAGE	DIMENSIONS	WEIGHT	PACKING	MOQ	PRICE (€)
145-59932	5207227151552	6	4000	80	300mA	115x25x133mm	0,23kg	1/20	1	31,65
145-59933	5207227151569	12	4000	80	600mA	115x25x133mm	0,45kg	1/20	1	39,90
145-59936	5207227259234	6	3000	66	300mA	115x25x133mm	0,23kg	1/20	1	31,65
145-59937	5207227259241	12	3000	66	600mA	115x25x133mm	0,45kg	1/20	1	39,90

ΡΥΘΜΙΖΟΜΕΝΟ ΣΠΟΤ ΜΑΓΝΗΤΙΚΗΣ ΡΑΓΑΣ LED ADJUSTABLE LED TRACKING SPOT LIGHT

PLUS
SERIES

3
CCT

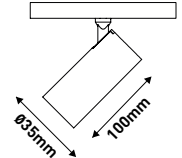

Volt: **48V DC 50/60Hz** • LED Type: **COB1304**

3CCT: **2700K/4000K/6000K**

Γωνία Δέσμης Φωτός / Beam Angle: **24°**

Ενεργειακή Κλάση / Energy Class: **G**

Start Time: **0,5sec** • PF > **0,50** • CRI >**90**

Υλικό / Material: **Αλουμίνιο / Aluminium**

Σύνδεση / Connection: **Copper spot connector**



COLOR
BLACK



ON
OFF
15.000

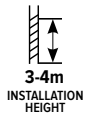

CODE	BARCODE	WATT	KELVIN	LUMEN/WATT	AMPERAGE	DIMENSIONS	WEIGHT	PACKING	MOQ	PRICE (€)
145-59938	5207227263378	7	3000	50	150mA	100x35mm	0,165kg	1/20	1	30,45
145-59939	5207227263392	7	4000	50	150mA	100x35mm	0,165kg	1/20	1	30,45
145-59942 *	5207227264719	7	3CCT	50	150mA	100x35mm	0,165kg	1/20	1	30,45

* ΔΙΑΘΕΣΙΜΟ ΜΕΤΑ ΤΗΝ ΕΞΑΝΤΛΗΣΗ ΤΩΝ 145-59938 & 145-59939 / AVAILABLE AFTER THE STOCK OUT OF 145-59938 & 145-59939

ΜΟΝΟΦΩΤΟ ΚΡΕΜΑΣΤΟ ΜΑΓΝΗΤΙΚΗΣ ΡΑΓΑΣ LED ΜΑΥΡΟ LED PENDANT SPOT LIGHT BLACK

PLUS
SERIES

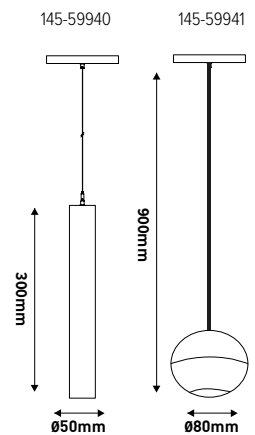

Volt: **48V DC 50/60Hz** • LED Type: **COB SMD1313**

Γωνία Δέσμης Φωτός / Beam Angle: **24°**

Ενεργειακή Κλάση / Energy Class: **F**

Start Time: **0,5sec** • PF > **0,50** • CRI >**80**

Υλικό / Material:

Αλουμίνιο & Πλαστικό / Aluminium & Plastic

Σύνδεση / Connection: **Copper spot connector**



ON
OFF
15.000



CODE	BARCODE	WATT	KELVIN	LUMEN/WATT	AMPERAGE	DIMENSIONS	WEIGHT	PACKING	MOQ	PRICE (€)
145-59940	5207227151576	10	4000	80	200mA	Ø50x300mm	0,200kg	1/30	1	33,85
145-59941	5207227151583	7	4000	80	150mA	Ø80x900mm	0,240kg	1/30	1	35,65

ΣΠΟΤ ΓΡΑΜΜΙΚΟ ΜΑΓΝΗΤΙΚΗΣ ΡΑΓΑΣ LED LED LINEAR FLOOD LIGHT LED



Volt: **48V DC 50/60Hz** • LED Type: **SMD2835**

Ενεργειακή Κλάση / Energy Class: **F**

Γωνία Δέσμης Φωτός / Beam Angle: **120°**

Start Time: **0,5sec** • PF > **0,50** • CRI > **80**

Υλικό / Material: **Αλουμίνιο & Πλαστικό / Aluminium & Plastic**

Σύνδεση / Connection: **Copper spot connector**

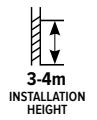
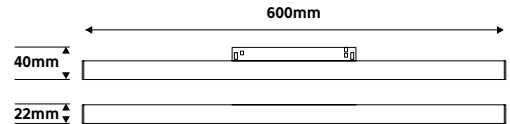

- 20 | +45 °C**
- NON DIMMABLE**
- FLICKER FREE**
- 0,300kg**
- COLOR BLACK**
- 50.000h**
- ON OFF 15.000**
- IP20**
- 3 YEARS WARRANTY**

CODE	BARCODE	WATT	KELVIN	LUMEN/W	AMPERAGE	DIMENSIONS	WEIGHT	PACKING	MOQ	PRICE (€)
145-59950	5207227151507	20	4000	80	400mA	600x22x40mm	0,300kg	1/50	1	22,85
145-59954	5207227259166	20	3000	80	500mA	600x22x24.5mm	11,65kg	1/25	1	22,85



Volt: **48V DC 50/60Hz**

Γωνία Δέσμης Φωτός / Beam Angle: **24°**

Ενεργειακή Κλάση / Energy Class: **F**

LED Type: **SMD2835**

Start Time: **0,5sec** • PF > **0,50** • CRI > **80**

Υλικό / Material: **Αλουμίνιο & Πλαστικό / Aluminium & Plastic**

Σύνδεση / Connection: **Copper spot connector**

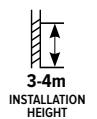
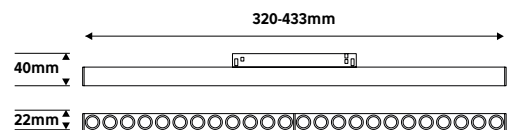

- 20 | +45 °C**
- NON DIMMABLE**
- FLICKER FREE**
- COLOR BLACK**
- 50.000h**
- ON OFF 15.000**
- IP20**
- 3 YEARS WARRANTY**

CODE	BARCODE	WATT	KELVIN	LUMEN/W	AMPERAGE	DIMENSIONS	WEIGHT	PACKING	MOQ	PRICE (€)
145-59952	5207227151514	18	4000	80	350mA	320x22x40mm	0,18kg	1/25	1	29,60
145-59953	5207227151521	24	4000	80	500mA	433x22x40mm	0,24kg	1/25	1	31,85
145-59955	5207227259180	18	3000	80	350mA	320x22x40mm	0,15kg	1/25	1	29,60
145-59956	5207227259203	24	3000	80	500mA	433x22x40mm	0,25kg	1/25	1	31,85

ΡΑΓΑ ΜΑΓΝΗΤΙΚΗ ΧΩΝΕΥΤΗ ΚΑΙ ΕΞΩΤΕΡΙΚΗ & ΑΞΕΣΟΥΑΡ

RECESSED, PENDANT, SURFACE MOUNTED MAGNETIC TRACK & ACCESSORIES

ΡΑΓΑ ΧΩΝΕΥΤΗ ΜΑΓΝΗΤΙΚΗ

RECESSED MAGNETIC TRACK



Volt: **DC 48V**

Υλικό / Material:

Αλουμίνιο & PVC / Aluminium & PVC



CODE	BARCODE	DIMENSIONS	WEIGHT	COLOR	PACKING	MOQ	PRICE (€)
145-59900	5207227157165	1000x64x43mm	1,2kg	BLACK	1/5	1	25,65
145-59901	5207227151590	2000x64x43mm	2,4kg	BLACK	1/5	1	51,45

ΡΑΓΑ ΕΞΩΤΕΡΙΚΗ ΜΑΓΝΗΤΙΚΗ

PENDANT & SURFACE MOUNTED MAGNETIC TRACK

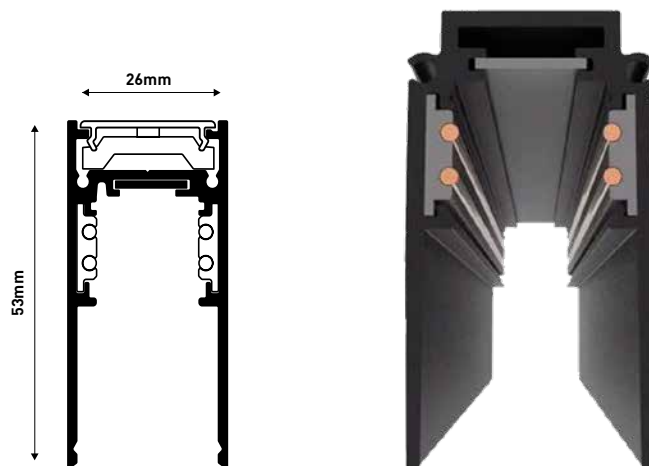

Volt: **DC 48V**

Υλικό / Material:

Αλουμίνιο & PVC / Aluminium & PVC



CODE	BARCODE	DIMENSIONS	WEIGHT	COLOR	PACKING	MOQ	PRICE (€)
145-59902	5207227157172	1000x53x26mm	0,92kg	BLACK	1/9	1	23,25
145-59903	5207227151606	2000x53x26mm	1,85kg	BLACK	1/5	1	47,20

ΤΡΟΦΟΔΟΤΙΚΟ 48V DC

DRIVER 48V DC



220x22x25mm

Volt: **100W DC 48V**

Υλικό / Material: **Αλουμίνιο & PVC / Aluminium & PVC**



-20 | +45 °C



0,23kg



IP20



3 YEARS WARRANTY

CODE	BARCODE	COLOR	PACKING	MOQ	PRICE (€)
145-59907	5207227151637	BLACK	1/30	1	58,35

ΤΡΟΦΟΔΟΤΙΚΟ 48V DC

DRIVER 48V DC



310x22x37mm

Volt: **200W DC 48V**

Υλικό / Material: **Αλουμίνιο & PVC / Aluminium & PVC**



-20 | +45 °C



0,35kg



IP20



3 YEARS WARRANTY

CODE	BARCODE	COLOR	PACKING	MOQ	PRICE (€)
145-59908	5207227151644	BLACK	1/30	1	98,80

ΤΡΟΦΟΔΟΣΙΑ

INPUT POWER CONNECTOR



520x18x18mm

Volt: **DC 48V (απαιτείται / is required)**

Υλικό / Material: **Αλουμίνιο & PVC / Aluminium & PVC**



-20 | +45 °C



0,08kg



IP20



5 YEARS WARRANTY

CODE	BARCODE	COLOR	PACKING	MOQ	PRICE (€)
145-59904	5207227151613	BLACK	1/100	1	7,95

ΕΝΩΤΙΚΟΣ ΣΥΝΔΕΣΜΟΣ

POWER CONNECTOR



365x18x18mm

Volt: **DC 48V**

Υλικό / Material: **Αλουμίνιο & PVC / Aluminium & PVC**



-20 | +45 °C



0,08kg



IP20



5 YEARS WARRANTY

CODE	BARCODE	COLOR	PACKING	MOQ	PRICE (€)
145-59906	5207227190971	BLACK	1/50	1	14,65

ΕΝΩΤΙΚΟΣ ΣΥΝΔΕΣΜΟΣ FLEXIBLE

FLEXIBLE POWER CONNECTOR



365x18x18mm

Volt: **DC 48V**

Υλικό / Material: **Αλουμίνιο & PVC / Aluminium & PVC**



-20 | +45 °C



0,08kg



IP20



5 YEARS WARRANTY

CODE	BARCODE	COLOR	PACKING	MOQ	PRICE (€)
145-59905	5207227151620	BLACK	1/50	1	13,55

ΣΥΝΔΕΣΜΟΣ ΕΥΘΕΙΑΣ ΧΩΝΕΥΤΗΣ STL-RA

CONJUNCTION STRAIGHT RECESSED STL-RA



70x7x2mm

Υλικό / Material: **Αλουμίνιο & PVC / Aluminium & PVC**



-20 | +45 °C



0,01kg



IP20



5 YEARS WARRANTY

CODE	BARCODE	COLOR	PACKING	MOQ	PRICE (€)
145-59915	5207227151705	BLACK	1/100	1	0,54

ΓΩΝΙΑ ΧΩΝΕΥΤΗ 90° STL-RLC01

RECESSED CORNER 90° STL-RLC01



100x100x43mm

Volt: **DC 48V**

Υλικό / Material: **Αλουμίνιο & PVC / Aluminium & PVC**



-20 | +45 °C



0,12kg



IP20



5 YEARS WARRANTY

CODE	BARCODE	COLOR	PACKING	MOQ	PRICE (€)
145-59910	5207227151651	BLACK	1/30	1	13,85

ΓΩΝΙΑ ΧΩΝΕΥΤΗ 90° STL-RLC02

RECESSED CORNER 90° STL-RLC02



100x100x43mm

Volt: **DC 48V**

Υλικό / Material: **Αλουμίνιο & PVC / Aluminium & PVC**



-20 | +45 °C



0,12kg



IP20



5 YEARS WARRANTY

CODE	BARCODE	COLOR	PACKING	MOQ	PRICE (€)
145-59911	5207227151668	BLACK	1/30	1	13,85

ΓΩΝΙΑ ΧΩΝΕΥΤΗ 90° STL-RLC03

RECESSED CORNER 90° STL-RLC03



100x100x43mm

Volt: **DC 48V**

Υλικό / Material: **Αλουμίνιο & PVC / Aluminium & PVC**



-20 | +45 °C



0,12kg



IP20



5 YEARS WARRANTY

CODE	BARCODE	COLOR	PACKING	MOQ	PRICE (€)
145-59912	5207227151675	BLACK	1/30	1	13,85

ΓΩΝΙΑ ΕΞΩΤΕΡΙΚΗΣ 90° STL-SLC02

SURFACE CORNER 90° STL-SLC02



100x100x64mm

Volt: **DC 48V**

Υλικό / Material: **Αλουμίνιο & PVC / Aluminium & PVC**



-20 | +45 °C



0,12kg



IP20



5 YEARS WARRANTY

CODE	BARCODE	COLOR	PACKING	MOQ	PRICE (€)
145-59913	5207227151682	BLACK	1/30	1	13,85

ΓΩΝΙΑ ΕΞΩΤΕΡΙΚΗΣ 90° STL-SLC01

SURFACE CORNER 90° STL-SLC01



100x100x64mm

Volt: **DC 48V**

Υλικό / Material: **Αλουμίνιο & PVC / Aluminium & PVC**



-20 | +45 °C



0,12kg



IP20



5 YEARS WARRANTY

CODE	BARCODE	COLOR	PACKING	MOQ	PRICE (€)
145-59914	5207227151699	BLACK	1/30	1	13,85

ΣΥΝΔΕΣΜΟΣ ΕΥΘΕΙΑΣ ΕΞΩΤΕΡΙΚΗΣ STL-SA

CONJUNCTION STRAIGHT SURFACE STL-SA



50x20x2mm

Υλικό / Material: **Αλουμίνιο & PVC / Aluminium & PVC**



-20 | +45 °C



0,02kg



IP20



5 YEARS WARRANTY

CODE	BARCODE	COLOR	PACKING	MOQ	PRICE (€)
145-59916	5207227151712	BLACK	1/100	1	0,98

NTIZA STL-SAB

SUSPENDING WIRE STL-SAB



2000x1.5x1.5mm

Υλικό / Material: **Αλουμίνιο & PVC / Aluminium & PVC**



-20 | +45 °C



0,15kg



IP20



5 YEARS WARRANTY

CODE	BARCODE	COLOR	PACKING	MOQ	PRICE (€)
145-59917	5207227151729	BLACK	1/100	1	5,85

NTIZA ΣΤΑΘΕΡΗ ET-TSR ΜΑΥΡΗ

SUSPENSION ROD STABLE ET-TSR BLACK



50x20x2mm

Υλικό / Material: **Αλουμίνιο & PVC / Aluminium & PVC**



-20 | +45 °C



0,02kg



IP20



5 YEARS WARRANTY

CODE	BARCODE	COLOR	PACKING	MOQ	PRICE (€)
145-59918	5207227190988	BLACK	1/100	1	36,95

ΤΑΠΑ ΓΙΑ ΧΩΝΕΥΤΗ ΣΕΤ 2 ΤΕΜΑΧΙΩΝ

END CAP FOR RECESSED SET 2 PCS



50x20x2mm

Υλικό / Material: **Αλουμίνιο & PVC / Aluminium & PVC**



-20 | +45 °C



0,02kg



IP20



5 YEARS WARRANTY

CODE	BARCODE	COLOR	PACKING	MOQ	PRICE (€)
145-59919	5207227190995	BLACK	1/100	1	1,15

ΤΑΠΑ ΓΙΑ ΕΞΩΤΕΡΙΚΗ ΣΕΤ 2 ΤΕΜΑΧΙΩΝ

END CAP FOR SURFACE SET 2 PCS



50x20x2mm

Υλικό / Material: **Αλουμίνιο & PVC / Aluminium & PVC**



-20 | +45 °C



0,02kg



IP20



5 YEARS WARRANTY

CODE	BARCODE	COLOR	PACKING	MOQ	PRICE (€)
145-59920	5207227191008	BLACK	1/100	1	1,15

ΒΑΣΗ ΟΡΟΦΗΣ ΓΙΑ ΜΑΓΝΗΤΙΚΗ ΡΑΓΑ

CEILING BASE FOR MAGNETIC TRACK



50x20x2mm

Υλικό / Material: **Αλουμίνιο & PVC / Aluminium & PVC**



-20 | +45 °C



0,02kg



IP20



5 YEARS WARRANTY

CODE	BARCODE	COLOR	PACKING	MOQ	PRICE (€)
145-59921	5207227205675	BLACK	1/100	1	1,85

Σποτ LED Ράγας
2 γραμμών

Track Spot LED Lights
2 lines



ΓΡΑΜΜΙΚΟ ΡΑΓΑΣ LED 2 ΓΡΑΜΜΩΝ LINEAR TRACK LIGHT LED SINGLE 2 LINE

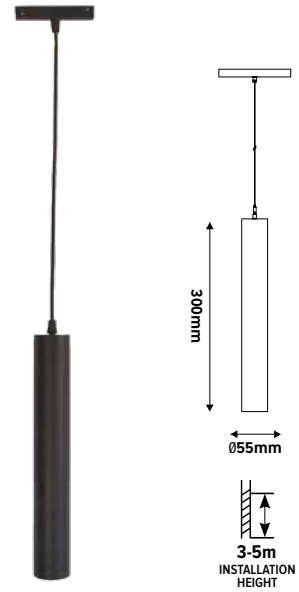

Volt: **100-265V 50/60Hz** • LED Type: **RNS 1350**

Γωνία Δέσμης Φωτός / Beam Angle: **24°**

Ενεργειακή Κλάση / Energy Class: **F**

Start Time: **1sec** • PF > **0,50** • CRI > **80**

Υλικό / Material:

Αλουμίνιο & Πλαστικό / Aluminium & Plastic



CODE	OLD CODE	BARCODE	WATT	KELVIN	LUMEN/W	DIMENSIONS	COLOR	PACKING	MOQ	PRICE (€)
145-59040	145-55086 *	5207227264191	10	4000	90	Ø55x300mm	WHITE	1/24	1	28,85
145-59041	145-55087 *	5207227151583	10	4000	90	Ø55x300mm	BLACK	1/24	1	28,85

* ΔΙΑΘΕΣΙΜΟ ΜΕΧΡΙ ΕΞΑΝΤΗΣΕΩΣ ΤΩΝ ΑΠΟΘΕΜΑΤΩΝ / AVAILABLE WHILE STOCKS LAST

ΣΠΟΤ ΡΑΓΑΣ LED TRACK LIGHT SINGLE



Volt: **230V 50/60Hz** • LED Type: **COB GU10**

Γωνία Δέσμης Φωτός / Beam Angle: **24°**

Ενεργειακή Κλάση / Energy Class: **G**

Start Time: **0,5sec** • PF > **0,50** • CRI > **80**

Υλικό / Material:

Αλουμίνιο & Πλαστικό / Aluminium & Plastic



CODE	BARCODE	WATT	KELVIN	LUMEN/WATT	DIMENSIONS	COLOR	PACKING	MOQ	PRICE (€)
145-59058	5207227151156	12	4000	85	Ø100x100mm	WHITE	1/20	1	42,85
145-59059	5207227151163	12	4000	85	Ø100x100mm	BLACK	1/20	1	42,85



ΣΠΟΤ ΡΑΓΑΣ LED 2 ΓΡΑΜΜΩΝ TRACK LIGHT LED SINGLE 2 LINE



Volt: **100-265V 50/60Hz** • LED Type: **COB1919**

Γωνία Δέσμης Φωτός / Beam Angle: **24°**

Ενεργειακή Κλάση / Energy Class: **F**

Start Time: **1sec** • PF > **0,50** • CRI > **80**

Υλικό / Material:

Αλουμίνιο & Πλαστικό / Aluminium & Plastic

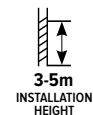
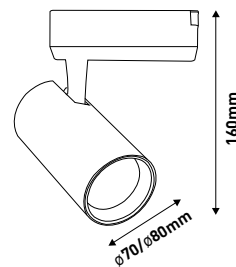

-20 | +45 °C
 NON DIMMABLE
 FLICKER FREE
 Lm/W 90
 15.000h
 ON OFF 15.000
 IP20
 2 YEARS WARRANTY

CODE	OLD CODE	BARCODE	WATT	KELVIN	DIMENSIONS	WEIGHT	COLOR	PACKING	MOQ	PRICE (€)
145-59050	145-55082 *	5207227205781	20	4000	Ø70x160mm	0,480kg	WHITE	1/30	1	22,65
145-59051	145-55083 *	5207227205804	20	4000	Ø70x160mm	0,480kg	BLACK	1/30	1	22,65
145-59052		5207227158407	20	3000	Ø70x160mm	0,480kg	WHITE	1/24	1	22,65
145-59053		5207227158414	20	3000	Ø70x160mm	0,480kg	BLACK	1/24	1	22,65
145-59054	145-55084 *	5207227220272	30	4000	Ø80x180mm	0,720kg	WHITE	1/40	1	27,55
145-59055	145-55085 *	5207227264238	30	4000	Ø80x180mm	0,720kg	BLACK	1/20	1	27,55
145-59056		5207227158421	30	3000	Ø80x180mm	0,720kg	WHITE	1/20	1	27,55
145-59057		5207227158438	30	3000	Ø80x180mm	0,720kg	BLACK	1/20	1	27,55

* ΔΙΑΘΕΣΙΜΟ ΜΕΧΡΙ ΕΞΑΝΤΗΣΕΩΣ ΤΩΝ ΑΠΟΘΕΜΑΤΩΝ / AVAILABLE WHILE STOCKS LAST



Volt: **170-265V 50/60Hz** • LED Type: **COB1919**

Γωνία Δέσμης Φωτός / Beam Angle: **35°**

Ενεργειακή Κλάση / Energy Class: **F**

Start Time: **0,5sec** • PF > **0,50** • CRI > **80**

Υλικό / Material:

Αλουμίνιο & Πλαστικό / Aluminium & Plastic

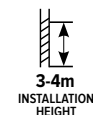
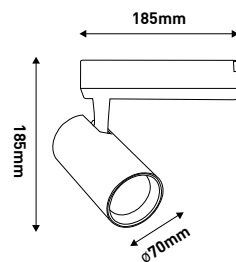

-20 | +45 °C
 NON DIMMABLE
 FLICKER FREE
 1,450kg
 50.000h
 ON OFF 15.000
 IP20
 2 YEARS WARRANTY

CODE	BARCODE	WATT	KELVIN	LUMEN/WATT	DIMENSIONS	COLOR	PACKING	MOQ	PRICE (€)
145-59046	5207227264214	20	4000	85	185x185xØ70mm	WHITE	1/30	1	19,95
145-59047	5207227264221	20	4000	85	185x185xØ70mm	BLACK	1/30	1	19,95



ΣΠΟΤ ΡΑΓΑΣ LED 2 ΓΡΑΜΜΩΝ TRACK LIGHT LED 2 LINE



Ø53x200x180mm

Ονομαστική Ισχύς / Nominal Power: **max 7W led**

Υλικό / Material:

Αλουμίνιο & Πλαστικό / Aluminium & Plastic

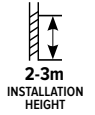
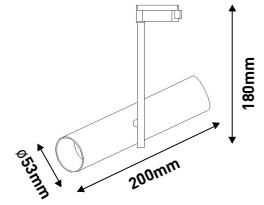

CODE	BARCODE	OPERATING TEMPERATURE	TYPE	COLOR	PACKING	MOQ	PRICE (€)
145-59075	5207227151118	-20/+45°C	GU10	WHITE	1/20	1	22,95
145-59085	5207227151125	-20/+45°C	GU10	BLACK	1/20	1	22,95

Ø34x55.5x120mm

Ονομαστική Ισχύς / Nominal Power: **max 7W led - Led/Halogen**

Υλικό / Material:

Αλουμίνιο & Πλαστικό / Aluminium & Plastic

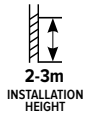
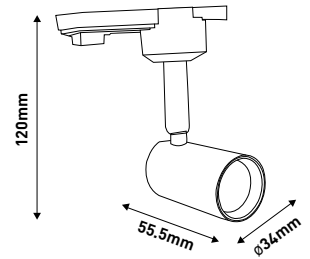

CODE	OLD CODE	BARCODE	OPERATING TEMPERATURE	TYPE	COLOR	PACKING	MOQ	PRICE (€)
145-59070	145-55050 *	5207227220296	-20/+45°C	GU10	WHITE	1/100	1	12,35
145-59080	145-55060 *	5207227264283	-20/+45°C	GU10	BLACK	1/100	1	12,35

* ΔΙΑΘΕΣΙΜΟ ΜΕΧΡΙ ΕΞΑΝΤΛΗΣΕΩΣ ΤΩΝ ΑΠΟΘΕΜΑΤΩΝ / AVAILABLE WHILE STOCKS LAST



Ø60x103mm

Ονομαστική Ισχύς / Nominal Power: **max 7W led - Led/Halogen**

Υλικό / Material:

Αλουμίνιο & Πλαστικό / Aluminium & Plastic

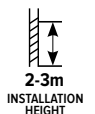
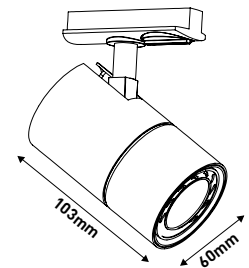

CODE	OLD CODE	BARCODE	OPERATING TEMPERATURE	TYPE	COLOR	PACKING	MOQ	PRICE (€)
145-59073	145-55053 *	5207227264269	-20/+45°C	GU10	WHITE	1/24	1	19,85
145-59083	145-55063 *	5207227264306	-20/+45°C	GU10	BLACK	1/24	1	19,85

* ΔΙΑΘΕΣΙΜΟ ΜΕΧΡΙ ΕΞΑΝΤΛΗΣΕΩΣ ΤΩΝ ΑΠΟΘΕΜΑΤΩΝ / AVAILABLE WHILE STOCKS LAST

ΣΠΟΤ ΡΑΓΑΣ LED 2 ΓΡΑΜΜΩΝ TRACK LIGHT LED 2 LINE



34x55.5x120mm

Ονομαστική Ισχύς / Nominal Power: **max 7W led - Led/Halogen**

Υλικό / Material:

Αλουμίνιο & Πλαστικό / Aluminium & Plastic

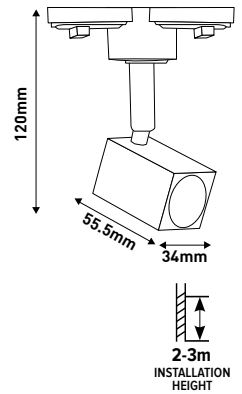

CODE	OLD CODE	BARCODE	OPERATING TEMPERATURE	TYPE	COLOR	PACKING	MOQ	PRICE (€)
145-59071	145-55051 *	5207227264245	-20/+45°C	GU10	WHITE	1/100	1	12,35
145-59081	145-55061 *	5207227264290	-20/+45°C	GU10	BLACK	1/100	1	12,35

* ΔΙΑΘΕΣΙΜΟ ΜΕΧΡΙ ΕΞΑΝΤΛΗΣΕΩΣ ΤΩΝ ΑΠΟΘΕΜΑΤΩΝ / AVAILABLE WHILE STOCKS LAST



35x55.5x190mm

Ονομαστική Ισχύς / Nominal Power: **max 7W led - Led/Halogen**

Υλικό / Material:

Αλουμίνιο & Πλαστικό / Aluminium & Plastic

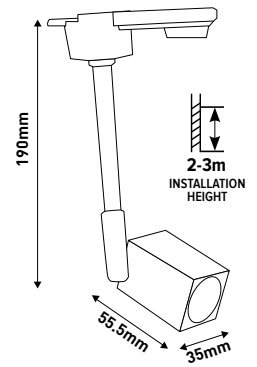

CODE	OLD CODE	BARCODE	OPERATING TEMPERATURE	TYPE	COLOR	PACKING	MOQ	PRICE (€)
145-59072	145-55052 *	5207227264252	-20/+45°C	GU10	WHITE	1/20	1	13,65
145-59082	145-55062 *	5207227205828	-20/+45°C	GU10	BLACK	1/20	1	13,65

* ΔΙΑΘΕΣΙΜΟ ΜΕΧΡΙ ΕΞΑΝΤΛΗΣΕΩΣ ΤΩΝ ΑΠΟΘΕΜΑΤΩΝ / AVAILABLE WHILE STOCKS LAST



ΡΑΓΑ 2 ΓΡΑΜΜΩΝ & ΑΞΕΣΟΥΑΡ 2 LINE TRACK & ACCESSORIES

ΡΑΓΑ UNIVERSAL 2 ΓΡΑΜΜΩΝ

UNIVERSAL TRACK 2 LINES

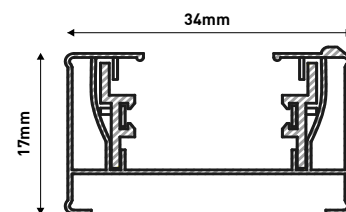

Υλικό / Material: **Αλουμίνιο & PVC / Aluminium & PVC**

V
 220-240V

-20 | +45 °C

IP20

5 YEARS WARRANTY

CODE	BARCODE	DIMENSIONS	WEIGHT	COLOR	PACKING	MOQ	PRICE (€)
145-59000	5207227264467	973x34x17mm	0,455kg	WHITE	1/20	1	8,15
145-59001	5207227220258	1973x34x17mm	0,500kg	WHITE	1/20	1	16,20
145-59020	5207227220210	973x34x17mm	0,455kg	BLACK	1/20	1	8,15
145-59021	5207227220234	1973x34x17mm	0,630kg	BLACK	1/20	1	16,20



ΤΡΟΦΟΔΟΣΙΑ ΡΑΓΑΣ UNIVERSAL

POWER TRACK UNIVERSAL



Σύνδεση / Connection: **Κλέμμα / Terminal Block**

Υλικό / Material: **Αλουμίνιο & PVC / Aluminium & PVC**



CODE	BARCODE	COLOR	PACKING	MOQ	PRICE (€)
145-59002	5207227263712	WHITE	1/20	1	2,95
145-59022	5207227263798	BLACK	1/20	1	2,95

ΣΥΝΔΕΣΜΟΣ UNIVERSAL ΕΥΘΕΙΑΣ

CONJUNCTION UNIVERSAL STRAIGHT



Υλικό / Material: **Αλουμίνιο & PVC / Aluminium & PVC**



CODE	BARCODE	COLOR	PACKING	MOQ	PRICE (€)
145-59003	5207227263729	WHITE	1/20	1	2,65
145-59023	5207227240959	BLACK	1/20	1	2,65

ΣΥΝΔΕΣΜΟΣ UNIVERSAL ΓΩΝΙΑΣ 90°

CONJUNCTION UNIVERSAL ANGLE 90°

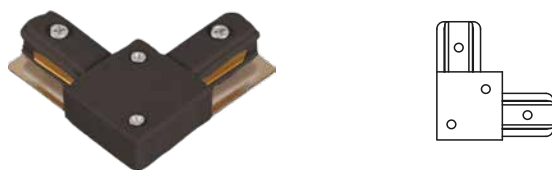

Υλικό / Material: **Αλουμίνιο & PVC / Aluminium & PVC**



CODE	BARCODE	COLOR	PACKING	MOQ	PRICE (€)
145-59004	5207227263736	WHITE	1/20	1	2,65
145-59024	5207227263804	BLACK	1/20	1	2,65

ΣΥΝΔΕΣΜΟΣ UNIVERSAL ΓΩΝΙΑΣ ΣΠΙΡΑΛ

CONJUNCTION UNIVERSAL SPIRAL ANGLE



Υλικό / Material: **Αλουμίνιο & PVC / Aluminium & PVC**



CODE	BARCODE	COLOR	PACKING	MOQ	PRICE (€)
145-59005	5207227263743	WHITE	1/300	1	10,55
145-59025	5207227263811	BLACK	1/300	1	10,55

ΣΥΝΔΕΣΜΟΣ UNIVERSAL ΤΑΦ

CONJUNCTION UNIVERSAL TYPE "T"



Υλικό / Material: **Αλουμίνιο & PVC / Aluminium & PVC**



CODE	BARCODE	COLOR	PACKING	MOQ	PRICE (€)
145-59006	5207227263750	WHITE	1/50	1	3,55
145-59026	5207227263828	BLACK	1/50	1	3,55

ΣΥΝΔΕΣΜΟΣ UNIVERSAL ΣΤΑΥΡΟΣ

CONJUNCTION UNIVERSAL TYPE "CROSS"



Υλικό / Material: **Αλουμίνιο & PVC / Aluminium & PVC**



CODE	BARCODE	COLOR	PACKING	MOQ	PRICE (€)
145-59007	5207227263767	WHITE	1/50	1	4,35
145-59027	5207227263835	BLACK	1/50	1	4,35

ΤΕΡΜΑΤΙΚΟ UNIVERSAL

UNIVERSAL TERMINAL



Υλικό / Material: **Αλουμίνιο & PVC / Aluminium & PVC**

0,033kg **-20 | +45 °C** **IP20** **5 YEARS WARRANTY**

CODE	BARCODE	COLOR	PACKING	MOQ	PRICE (€)
145-59008	5207227263774	WHITE	1/50	1	0,56
145-59028	5207227263842	BLACK	1/50	1	0,56

ΝΤΙΖΑ ΦΩΤΙΣΤΙΚΟΥ ΜΕ ΡΟΖΕΤΑ 2m

SUSPENDING WIRE FOR LIGHT FIXTURE WITH ROSETTE 2m



Υλικό / Material: **Αλουμίνιο & PVC / Aluminium & PVC**

0,006kg **-20 | +45 °C** **IP20** **5 YEARS WARRANTY**

CODE	BARCODE	COLOR	PACKING	MOQ	PRICE (€)
145-59009	5207227263781	WHITE	1/50	1	6,65
145-59029	5207227263859	BLACK	1/50	1	6,65

ΑΝΤΑΠΤΟΡΑΣ ΜΕ ΚΑΛΩΔΙΟ 2m Ø8mm

ADAPTOR WITH WIRE 2m Ø8mm



Υλικό / Material: **PVC & Χαλκός / PVC & Copper**

0,210kg **V** **220-240V** **-20 | +45 °C** **IP20** **5 YEARS WARRANTY**

CODE	BARCODE	COLOR	PACKING	MOQ	PRICE (€)
145-59010	5207227191435	WHITE	1/300	1	8,85
145-59030	5207227191442	BLACK	1/300	1	8,85

Σποτ LED Ράγας
4 γραμμών

Track Spot LED Lights
4 lines



ΣΠΟΤ ΡΑΓΑΣ LED 4 ΓΡΑΜΜΩΝ TRACK LIGHT LED SINGLE 4 LINE



Ø75x160mm

Volt: **220-240V 50/60Hz** • LED Type: **COB 1919**

Γωνία Δέσμης Φωτός / Beam Angle: **24°**

Ενεργειακή Κλάση / Energy Class: **F**

Start Time: **0,5sec** • PF > **0,50** • CRI > **80** • Amperage: **220mA**

Υλικό / Material: **Αλουμίνιο & Πλαστικό / Aluminium & Plastic**

Σύνδεση / Connection: **Αντάπτορας 4 καλωδίων / 4 Wire Adaptor**

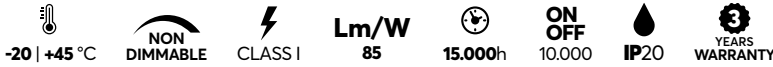
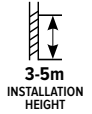
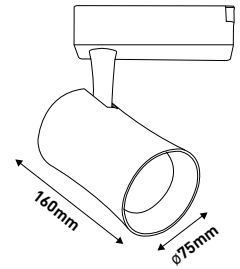

CODE	OLD CODE	BARCODE	WATT	KELVIN	DIMENSIONS	WEIGHT	COLOR	PACKING	MOQ	PRICE (€)
145-59300	145-55000 *	5207227263866	20	4000	Ø75x160mm	0,650kg	WHITE	1/24	1	38,25
145-59301	145-55001 *	5207227220357	20	4000	Ø75x160mm	0,650kg	BLACK	1/24	1	38,25
145-59302	-	5207227158964	20	3000	Ø75x160mm	0,650kg	WHITE	1/24	1	38,25
145-59303	-	5207227158995	20	3000	Ø75x160mm	0,650kg	BLACK	1/24	1	38,25

* ΔΙΑΘΕΣΙΜΟ ΜΕΧΡΙ ΕΞΑΝΤΗΣΕΩΣ ΤΩΝ ΑΠΟΘΕΜΑΤΩΝ / AVAILABLE WHILE STOCKS LAST



Ø84x160mm

Volt: **220-240V 50/60Hz** • LED Type: **COB 1919**

Γωνία Δέσμης Φωτός / Beam Angle: **24°**

Ενεργειακή Κλάση / Energy Class: **F**

Start Time: **0,5sec** • PF > **0,50** • CRI > **80** • Amperage: **300mA**

Υλικό / Material: **Αλουμίνιο & Πλαστικό / Aluminium & Plastic**

Σύνδεση / Connection: **Αντάπτορας 4 καλωδίων / 4 Wire Adaptor**

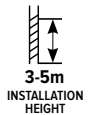
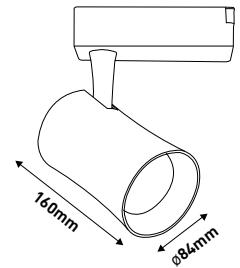

CODE	OLD CODE	BARCODE	WATT	KELVIN	DIMENSIONS	WEIGHT	COLOR	PACKING	MOQ	PRICE (€)
145-59304	145-55002 *	5207227263880	30	4000	Ø84x160mm	0,840kg	WHITE	1/20	1	42,95
145-59305	145-55003 *	5207227263897	30	4000	Ø84x160mm	0,840kg	BLACK	1/20	1	42,95
145-59306	-	5207227159022	30	3000	Ø84x160mm	0,840kg	WHITE	1/20	1	42,95
145-59307	-	5207227159046	30	3000	Ø84x160mm	0,840kg	BLACK	1/20	1	42,95

* ΔΙΑΘΕΣΙΜΟ ΜΕΧΡΙ ΕΞΑΝΤΗΣΕΩΣ ΤΩΝ ΑΠΟΘΕΜΑΤΩΝ / AVAILABLE WHILE STOCKS LAST



ΣΠΟΤ ΡΑΓΑΣ LED 4 ΓΡΑΜΜΩΝ TRACK LIGHT LED SINGLE 4 LINE

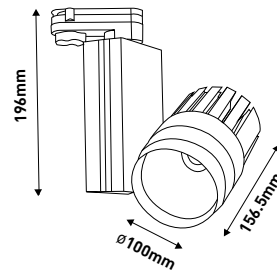

Ø100x156.5x196mm

Volt: **100-265V 50/60Hz** • LED Type: **COB 1919**

Amperage: **700mA**

Γωνία Δέσμης Φωτός / Beam Angle: **38°**

Ενεργειακή Κλάση / Energy Class: **F**

Start Time: **0,5sec** • PF > **0,90** • CRI > **80**

Υλικό / Material: **Αλουμίνιο & Πλαστικό / Aluminium & Plastic**

Σύνδεση / Connection: **Αντάπτορας 4 καλωδίων / 4 Wire Adaptor**

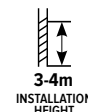

CODE	OLD CODE	BARCODE	KELVIN	DIMENSIONS	WEIGHT	COLOR	PACKING	MOQ	PRICE (€)
145-59315	145-55034 *	5207227263934	4000	Ø100x156,5x196mm	0,900kg	WHITE	1/10	1	82,65
145-59316	145-55035 *	5207227233784	4000	Ø100x156,5x196mm	0,900kg	BLACK	1/10	1	82,65

* ΔΙΑΘΕΣΙΜΟ ΜΕΧΡΙ ΕΞΑΝΤΗΣΕΩΣ ΤΩΝ ΑΠΟΘΕΜΑΤΩΝ / AVAILABLE WHILE STOCKS LAST

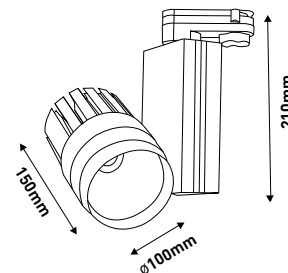

Ø100x150x210mm

Volt: **170-265V 50/60Hz** • LED Type: **COB 1919**

Amperage: **270mA**

Γωνία Δέσμης Φωτός / Beam Angle: **35°**

Ενεργειακή Κλάση / Energy Class: **F**

Start Time: **0,5sec** • PF > **0,50** • CRI > **80**

Υλικό / Material: **Αλουμίνιο & Πλαστικό / Aluminium & Plastic**

Σύνδεση / Connection: **Αντάπτορας 4 καλωδίων / 4 Wire Adaptor**

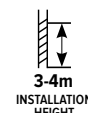

CODE	BARCODE	WATT	KELVIN	DIMENSIONS	WEIGHT	COLOR	PACKING	MOQ	PRICE (€)
145-59310	5207227233760	30	4000	Ø100x150x210mm	1,250kg	WHITE	1/12	1	43,65
145-59311	5207227233777	30	4000	Ø100x150x210mm	1,250kg	BLACK	1/12	1	43,65



ΣΠΟΤ ΡΑΓΑΣ LED 4 ΓΡΑΜΜΩΝ TRACK LIGHT LED SINGLE 4 LINE

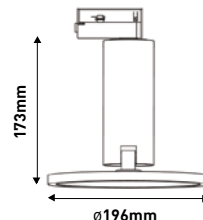

Ø197x173mm

Volt: **230V 50/60Hz** • LED Type: **SMD2835**

Amperage: **450mA**

Γωνία Δέσμης Φωτός / Beam Angle: **120°**

Ενεργειακή Κλάση / Energy Class: **G**

Start Time: **0,5sec** • PF > **0,50** • CRI > **80**

Υλικό / Material: **Αλουμίνιο & Πλαστικό / Aluminium & Plastic**

Σύνδεση / Connection: **Αντάπτορας 4 καλωδίων / 4 Wire Adaptor**

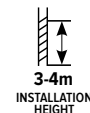

CODE	BARCODE	WATT	KELVIN	DIMENSIONS	WEIGHT	COLOR	PACKING	MOQ	PRICE (€)
145-59400	5207227150999	18	4000	Ø196x173mm	1,450kg	WHITE	1/20	1	78,90
145-59401	5207227151002	18	4000	Ø196x173mm	1,450kg	BLACK	1/20	1	78,90
145-59402	5207227151019	18	3000	Ø196x173mm	1,450kg	WHITE	1/20	1	78,90
145-59403	5207227151026	18	3000	Ø196x173mm	1,450kg	BLACK	1/20	1	78,90

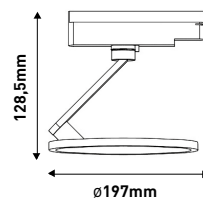

Ø197x128.5mm

Volt: **230V 50/60Hz** • LED Type: **SMD2835**

Amperage: **450mA**

Γωνία Δέσμης Φωτός / Beam Angle: **120°**

Ενεργειακή Κλάση / Energy Class: **G**

Start Time: **0,5sec** • PF > **0,50** • CRI > **80**

Υλικό / Material: **Αλουμίνιο & Πλαστικό / Aluminium & Plastic**

Σύνδεση / Connection: **Αντάπτορας 4 καλωδίων / 4 Wire Adaptor**

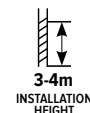

CODE	BARCODE	WATT	KELVIN	DIMENSIONS	WEIGHT	COLOR	PACKING	MOQ	PRICE (€)
145-59404	5207227151033	18	4000	Ø197x128,5mm	1,7kg	WHITE	1/16	1	86,60
145-59405	5207227151040	18	4000	Ø197x128,5mm	1,7kg	BLACK	1/16	1	86,60
145-59406	5207227151057	18	3000	Ø197x128,5mm	1,7kg	WHITE	1/16	1	86,60
145-59407	5207227151064	18	3000	Ø197x128,5mm	1,7kg	BLACK	1/16	1	86,60

ΣΠΟΤ ΡΑΓΑΣ LED 4 ΓΡΑΜΜΩΝ TRACK LIGHT LED SINGLE 4 LINE

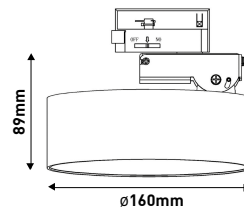

Ø160x89mm / Ø140x65mm

Volt: **230V 50/60Hz** • LED Type: **SMD2835**

Amperage: **450mA**

Γωνία Δέσμης Φωτός / Beam Angle: **120°**

Ενεργειακή Κλάση / Energy Class: **G**

Start Time: **0,5sec** • PF > **0,50** • CRI > **80**

Υλικό / Material: **Αλουμίνιο & Πλαστικό / Aluminium & Plastic**

Σύνδεση / Connection: **Αντάπτορας 4 καλωδίων / 4 Wire Adaptor**



CODE	BARCODE	WATT	KELVIN	DIMENSIONS	WEIGHT	COLOR	PACKING	MOQ	PRICE (€)
145-59408	5207227151071	18	4000	Ø160x89mm *	1,530kg	WHITE	1/20	1	68,85
145-59409	5207227151088	18	4000	Ø160x89mm *	1,530kg	BLACK	1/20	1	68,85
145-59410	5207227151095	18	3000	Ø160x89mm *	1,530kg	WHITE	1/20	1	68,85
145-59411	5207227151101	18	3000	Ø160x89mm *	1,530kg	BLACK	1/20	1	68,85

* ΔΙΑΣΤΑΣΕΙΣ ΤΩΝ ΝΕΩΝ ΠΑΡΑΛΑΒΩΝ Ø140x65mm / * DIMENSIONS OF THE NEW ARRIVALS Ø140x65mm



ΣΠΟΤ ΡΑΓΑΣ LED 4 ΓΡΑΜΜΩΝ TRACK LIGHT LED SINGLE 4 LINE



Ø90x260mm

Volt: **220-240V 50/60Hz** • LED Type: **COB 1919**

Amperage: **700mA**

Γωνία Δέσμης Φωτός / Beam Angle: **38°**

Ενεργειακή Κλάση / Energy Class: **F**

Start Time: **0,5sec** • PF > **0,90** • CRI > **80**

Υλικό / Material: **Αλουμίνιο & Πλαστικό / Aluminium & Plastic**

Σύνδεση / Connection: **Αντάπτορας 4 καλωδίων / 4 Wire Adaptor**

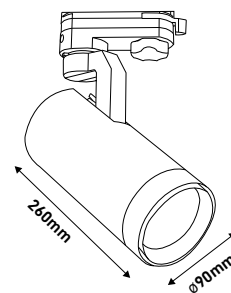

CODE	OLD CODE	BARCODE	KELVIN	DIMENSIONS	WEIGHT	COLOR	PACKING	MOQ	PRICE (€)
145-59312	145-55044 *	5207227263910	4000	Ø90x260mm	0,900kg	WHITE	1/15	1	76,65
145-59313	145-55045 *	5207227240973	4000	Ø90x260mm	0,900kg	BLACK	1/15	1	76,65

* ΔΙΑΘΕΣΙΜΟ ΜΕΧΡΙ ΕΞΑΝΤΛΗΣΕΩΣ ΤΩΝ ΑΠΟΘΕΜΑΤΩΝ / AVAILABLE WHILE STOCKS LAST

ΠΕΡΣΙΔΑ ΓΙΑ ΣΠΟΤ ΡΑΓΑΣ BLIND FOR SPOT LIGHT

Υλικό / Material:
Μεταλλικό/ Metallic

0,340kg
COLOR BLACK



CODE	OLD CODE	BARCODE	DIMENSIONS	PACKING	MOQ	PRICE (€)
145-59314	145-55046 *	5207227263927	Ø233x83x83mm	1/30	1	13,25

* ΔΙΑΘΕΣΙΜΟ ΜΕΧΡΙ ΕΞΑΝΤΛΗΣΕΩΣ ΤΩΝ ΑΠΟΘΕΜΑΤΩΝ / AVAILABLE WHILE STOCKS LAST

ΦΩΤΙΣΤΙΚΟ ΡΑΓΑΣ 4 ΓΡΑΜΜΩΝ PAR30 TRACK LIGHT FIXTURE SINGLE 4 LINE PAR30



Ø120x150x200mm

Volt: **220-240V**

Ονομαστική Ισχύς / Nominal Power:

max 15W led

Υλικό / Material: **Αλουμίνιο & Πλαστικό / Aluminium & Plastic**

Σύνδεση / Connection: **Αντάπτορας 4 καλωδίων / 4 Wire Adaptor**

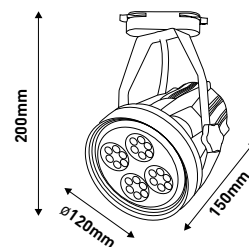

CODE	OLD CODE	BARCODE	OPERATING TEMPERATURE	TYPE	COLOR	PACKING	MOQ	PRICE (€)
145-59380	145-55032 *	5207227263958	-20 / +45°C	E27	BLACK	1/24	1	18,65
145-59381	145-55033 *	5207227263965	-20 / +45°C	E27	WHITE	1/24	1	18,65

* ΔΙΑΘΕΣΙΜΟ ΜΕΧΡΙ ΕΞΑΝΤΛΗΣΕΩΣ ΤΩΝ ΑΠΟΘΕΜΑΤΩΝ / AVAILABLE WHILE STOCKS LAST

ΡΥΘΜΙΖΟΜΕΝΟ ΣΠΟΤ ΡΑΓΑΣ LED 4 ΓΡΑΜΜΩΝ ADJUSTABLE TRACK LIGHT LED SINGLE 4 LINE

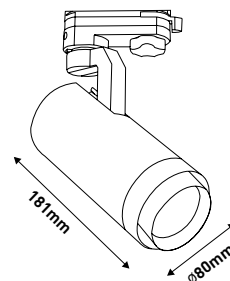

Ø80x181mm

Volt: **220-240V 50/60Hz** • LED Type: **COB1919**

3CCT: **3000K/4000K/6000K**

Amperage: **700mA**

Γωνία Δέσμης Φωτός / Beam Angle: **20°-60°**

Ενεργειακή Κλάση / Energy Class: **F**

Start Time: **0,5sec** • PF > **0,90** • CRI > **80**

Υλικό / Material: **Αλουμίνιο / Aluminium**

Σύνδεση / Connection: **Αντάπτορας 4 καλωδίων / 4 Wire Adaptor**

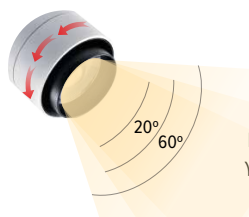

With adjustable light angle

Με ρυθμιζόμενη γωνία φωτισμού

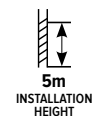
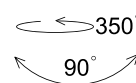

CODE	OLD CODE	BARCODE	KELVIN	DIMENSIONS	WEIGHT	COLOR	PACKING	MOQ	PRICE (€)
145-59350	145-55030 *	5207227263941	3CCT	Ø80x181mm	0,950kg	WHITE	1/8	1	85,85
145-59351	145-55031 *	5207227240980	3CCT	Ø80x181mm	0,950kg	BLACK	1/15	1	85,85

* ΔΙΑΘΕΣΙΜΟ ΜΕΧΡΙ ΕΞΑΝΤΛΗΣΕΩΣ ΤΩΝ ΑΠΟΘΕΜΑΤΩΝ / AVAILABLE WHILE STOCKS LAST

ΣΠΟΤ ΡΑΓΑΣ DIMMING LED 4 ΓΡΑΜΜΩΝ ΜΕ TRIAC TRACK LIGHT DIMMING LED SINGLE 4 LINE WITH TRIAC

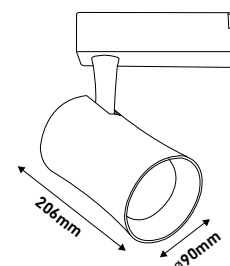

Volt: **220-240V 50/60Hz** • LED Type: **COB**

3CCT: **3000K/4000K/6000K**

Amperage: **700mA**

Γωνία Δέσμης Φωτός / Beam Angle: **12°/24°/36°/45°/60°**

Ενεργειακή Κλάση / Energy Class: **G**

Start Time: **0,5sec** • PF > **0,90** • CRI > **90**

Υλικό / Material: **Αλουμίνιο & Πλαστικό / Aluminium & Plastic**

Σύνδεση / Connection: **Copper spot connector**

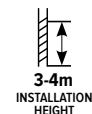
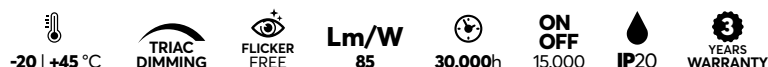

CODE	BARCODE	WATT	KELVIN	DIMENSIONS	WEIGHT	COLOR	PACKING	MOQ	PRICE (€)
145-59330	5207227298493	30	3CCT	Ø90x206x240mm	0,850kg	WHITE	1/15	1	79,21
145-59331	5207227298516	30	3CCT	Ø90x206x240mm	0,850kg	BLACK	1/15	1	79,21

ΣΠΟΤ ΡΑΓΑΣ ΓΡΑΜΜΙΚΟ LED 4 ΓΡΑΜΜΩΝ LINEAR TRACK LIGHT LED 4 LINE



567x42x63mm / 1122x42x63mm

Volt: **230V 50/60Hz** • LED Type: **SMD2835**

Γωνία Δέσμης Φωτός / Beam Angle: **120°**

Ενεργειακή Κλάση / Energy Class: **G**

Start Time: **0,5sec** • PF > **0,50** • CRI > **80**

Υλικό / Material: **Αλουμίνιο & Πλαστικό / Aluminium & Plastic**

Σύνδεση / Connection: **Αντάπτορας 4 καλωδίων / 4 Wire Adaptor**

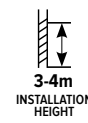

CODE	BARCODE	WATT	KELVIN	AMPERAGE	DIMENSIONS	WEIGHT	COLOR	PACKING	MOQ	PRICE (€)
145-59602	5207227151170	24	4000	600mA	567x42x63mm	1,500kg	WHITE	1/10	1	79,80
145-59603	5207227151187	24	4000	600mA	567x42x63mm	1,500kg	BLACK	1/10	1	79,80
145-59604	5207227151194	48	4000	600mA	1122x42x63mm	3,100kg	WHITE	1/8	1	136,80
145-59605	5207227151200	48	4000	600mA	1122x42x63mm	3,100kg	BLACK	1/8	1	136,80



ΣΠΟΤ ΡΑΓΑΣ ΓΡΑΜΜΙΚΟ LED ΜΟΝΟ 4 ΓΡΑΜΜΩΝ LINEAR TRACK LIGHT LED SINGLE 4 LINE



145-55090



145-55091

495x33x58mm

Volt: **220-240V 50/60Hz** • LED Type: **SMD2835**

Ενεργειακή Κλάση / Energy Class: **F**

Start Time: **0,5sec** • PF > **0,50** • CRI > **80**

Υλικό / Material: **Αλουμινίο & Πλαστικό / Aluminium & Plastic**

Σύνδεση / Connection: **Αντάπτορας 4 καλωδίων / 4 Wire Adaptor**



CODE	BARCODE	WATT	KELVIN	BEAM ANGLE	AMPERAGE	WEIGHT	COLOR	PACKING	MOQ	PRICE (€)
145-55090	5207227061622	15	4000	24°	60mA	0,425kg	WHITE/BLACK	1/20	1	46,85
145-55091	5207227061646	20	4000	100°	100mA	0,480kg	WHITE	1/20	1	41,85



ΡΑΓΑ ΧΩΝΕΥΤΗ 4 ΓΡΑΜΜΩΝ & ΑΞΕΣΟΥΑΡ RECESSED 4 LINE TRACK & ACCESSORIES

ΡΑΓΑ ΧΩΝΕΥΤΗ 4 ΓΡΑΜΜΩΝ

RECESSED 4 LINE TRACK

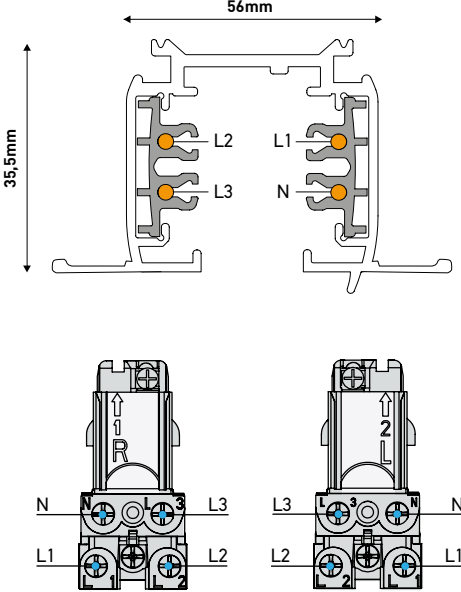

Υλικό / Material: **Αλουμίνιο & Πλαστικό/ Aluminium & Plastic**

V 100-265V
 -20 | +45 °C
 IP20
 2 YEARS WARRANTY

CODE	BARCODE	DIMENSIONS	WEIGHT	COLOR	PACKING	MOQ	PRICE (€)
145-59240	5207227151330	910x56x35,5mm	0,910kg	WHITE	1/8	1	27,35
145-59241	5207227151347	1910x56x35,5mm	1,860kg	WHITE	1/8	1	54,55
145-59250	5207227151422	910x56x35,5mm	0,910kg	BLACK	1/8	1	27,35
145-59251	5207227151439	1910x56x35,5mm	1,860kg	BLACK	1/8	1	54,55

ΤΡΟΦΟΔΟΣΙΑ

POWER

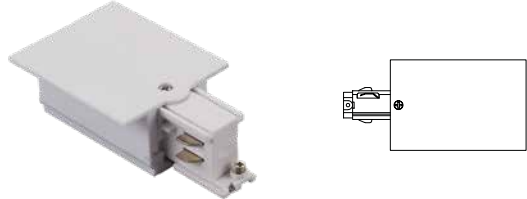

Υλικό / Material: **PVC & Copper**

0,060kg
 V 220-240V
 -20 | +45 °C
 IP20
 1 YEAR WARRANTY

CODE	BARCODE	COLOR	PACKING	MOQ	PRICE (€)
145-59242	5207227151354	WHITE	1/50	1	6,45
145-59252	5207227151446	BLACK	1/50	1	6,45

ΣΥΝΔΕΣΜΟΣ ΕΥΘΕΙΑΣ

STRAIGHT CONJUNCTION

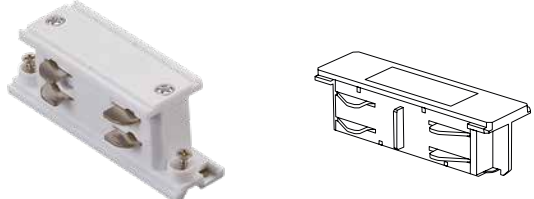

Υλικό / Material: **PVC & Copper**

0,060kg
 V 220-240V
 -20 | +45 °C
 IP20
 1 YEAR WARRANTY

CODE	BARCODE	COLOR	PACKING	MOQ	PRICE (€)
145-59243	5207227151361	WHITE	1/500	1	4,65
145-59253	5207227151453	BLACK	1/500	1	4,65

ΣΥΝΔΕΣΜΟΣ ΓΩΝΙΑΣ 90°

CONJUNCTION ANGLE 90°



Υλικό / Material: **PVC & Copper**



CODE	BARCODE	COLOR	PACKING	MOQ	PRICE (€)
145-59245	5207227151378	WHITE	1/50	1	10,85
145-59255	5207227151460	BLACK	1/50	1	10,85

ΣΥΝΔΕΣΜΟΣ ΤΥΠΟΥ "T"

CONJUNCTION TYPE "T"

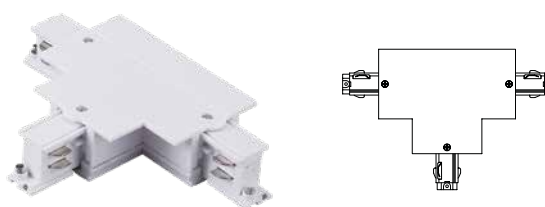

Υλικό / Material: **PVC & Copper**



CODE	BARCODE	COLOR	PACKING	MOQ	PRICE (€)
145-59246	5207227151385	WHITE	1/25	1	16,15
145-59256	5207227151477	BLACK	1/25	1	16,15

ΣΥΝΔΕΣΜΟΣ ΤΥΠΟΥ "ΣΤΑΥΡΟΣ"

CONJUNCTION TYPE "CROSS"

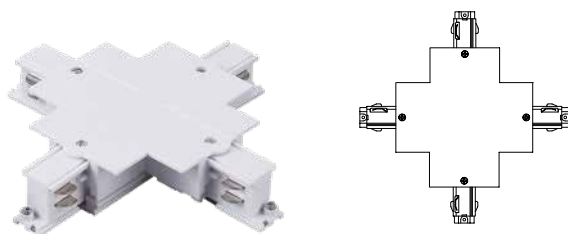

Υλικό / Material: **PVC & Copper**



CODE	BARCODE	COLOR	PACKING	MOQ	PRICE (€)
145-59247	5207227151392	WHITE	1/25	1	19,85
145-59257	5207227151484	BLACK	1/25	1	19,85

ΤΕΡΜΑΤΙΚΟ

TERMINAL

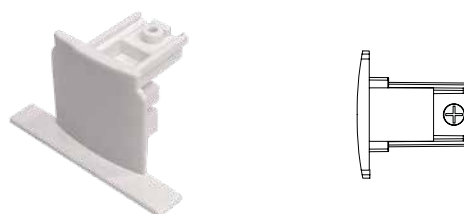

Υλικό / Material: **PVC**



CODE	BARCODE	COLOR	PACKING	MOQ	PRICE (€)
145-59248	5207227151408	WHITE	1/500	1	1,65
145-59258	5207227151491	BLACK	1/500	1	1,65

ΕΞΑΡΤΗΜΑ ΣΤΗΡΙΞΗΣ

SUPPORTING ACCESSORY

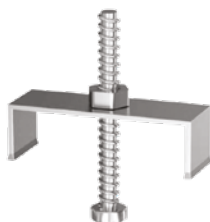

Υλικό / Material: **Μεταλλικό / Metal**



CODE	BARCODE	COLOR	PACKING	MOQ	PRICE (€)
145-59249	5207227151415	METAL	1/500	1	2,65

ΡΑΓΑ 4 ΓΡΑΜΜΩΝ UNIVERSAL & ΑΞΕΣΟΥΑΡ 4 LINE TRACK UNIVERSAL & ACCESSORIES

ΡΑΓΑ UNIVERSAL 4 ΓΡΑΜΜΩΝ

UNIVERSAL TRACK 4 LINES

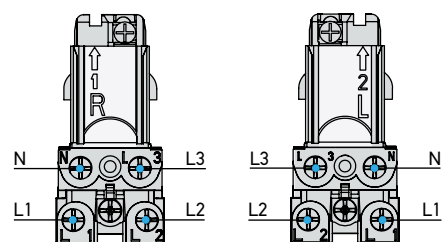
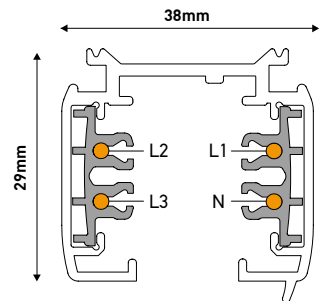

Υλικό / Material: **Αλουμίνιο & PVC / Aluminium & PVC**

- V**
220-240V
- 20 | +45 °C**
- IP20**
- 5 YEARS WARRANTY**

CODE	BARCODE	DIMENSIONS	WEIGHT	COLOR	PACKING	MOQ	PRICE (€)
145-59200	5207227263972	990x38x29mm	0,816kg	WHITE	1/10	1	22,45
145-59201	5207227263989	2000x38x29mm	1,630kg	WHITE	1/10	1	42,95
145-59215	5207227258398	2973x38x29mm	2,450kg	WHITE	1/10	1	75,65
145-59220	5207227264085	990x38x29mm	0,816kg	BLACK	1/10	1	22,45
145-59221	5207227264092	2000x38x29mm	1,630kg	BLACK	1/10	1	42,95
145-59235	5207227258404	2973x38x29mm	2,450kg	BLACK	1/10	1	75,65



ΤΡΟΦΟΔΟΣΙΑ ΡΑΓΑΣ UNIVERSAL

POWER TRACK UNIVERSAL



Σύνδεση / Connection: **Κλέμμα / Terminal Block**

Υλικό / Material: **Αλουμίνιο & PVC / Aluminium & PVC**



CODE	BARCODE	COLOR	PACKING	MOQ	PRICE (€)
145-59202	5207227263996	WHITE	1/20	1	4,75
145-59222	5207227264108	BLACK	1/20	1	4,75

ΣΥΝΔΕΣΜΟΣ UNIVERSAL ΕΥΘΕΙΑΣ

CONJUNCTION UNIVERSAL STRAIGHT



Υλικό / Material: **Αλουμίνιο & PVC / Aluminium & PVC**



CODE	BARCODE	COLOR	PACKING	MOQ	PRICE (€)
145-59203	5207227263996	WHITE	1/100	1	4,85
145-59223	5207227233753	BLACK	1/100	1	4,85

ΣΥΝΔΕΣΜΟΣ UNIVERSAL ΓΩΝΙΑΣ 90° ΜΕ ΤΡΟΦΟΔΟΣΙΑ

CONJUNCTION UNIVERSAL ANGLE 90° WITH POWER SUPPLY



Υλικό / Material: **Αλουμίνιο & PVC / Aluminium & PVC**



CODE	BARCODE	COLOR	PACKING	MOQ	PRICE (€)
145-59204	5207227240997	WHITE	1/20	1	9,85
145-59224	5207227220319	BLACK	1/20	1	9,85

ΣΥΝΔΕΣΜΟΣ UNIVERSAL ΓΩΝΙΑΣ ΣΠΙΡΑΛ

CONJUNCTION UNIVERSAL SPIRAL ANGLE



Υλικό / Material: **Αλουμίνιο & PVC / Aluminium & PVC**



CODE	BARCODE	COLOR	PACKING	MOQ	PRICE (€)
145-59205	5207227264016	WHITE	1/100	1	15,80
145-59225	5207227264115	BLACK	1/100	1	15,80

ΜΕΤΑΒΛΗΤΟΣ ΣΥΝΔΕΣΜΟΣ UNIVERSAL ΓΩΝΙΑΣ "L" ΜΕ ΤΡΟΦΟΔΟΣΙΑ

FLEXIBLE L-SHAPE CONJUNCTION UNIVERSAL WITH POWER SUPPLY



Υλικό / Material: **Αλουμίνιο & PVC / Aluminium & PVC**



CODE	BARCODE	COLOR	PACKING	MOQ	PRICE (€)
145-59206	5207227264023	WHITE	1/100	1	16,85
145-59226	5207227264122	BLACK	1/100	1	16,85

ΣΥΝΔΕΣΜΟΣ UNIVERSAL ΤΑΦ ΜΕ ΤΡΟΦΟΔΟΣΙΑ

CONJUNCTION UNIVERSAL TYPE "T" WITH POWER SUPPLY



Υλικό / Material: **Αλουμίνιο & PVC / Aluminium & PVC**

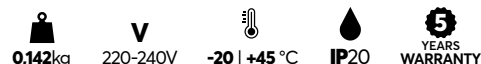

CODE	BARCODE	COLOR	PACKING	MOQ	PRICE (€)
145-59207	5207227264030	WHITE	1/1	1	12,65
145-59227	5207227264139	BLACK	1/1	1	12,65

ΣΥΝΔΕΣΜΟΣ UNIVERSAL ΣΤΑΥΡΟΣ ΜΕ ΤΡΟΦΟΔΟΣΙΑ

CONJUNCTION UNIVERSAL TYPE "CROSS" WITH POWER SUPPLY



Υλικό / Material: **Αλουμίνιο & PVC / Aluminium & PVC**



CODE	BARCODE	COLOR	PACKING	MOQ	PRICE (€)
145-59208	5207227264047	WHITE	1/1	1	16,85
145-59228	5207227264146	BLACK	1/1	1	16,85

ΤΕΡΜΑΤΙΚΟ ΡΑΓΑΣ UNIVERSAL

UNIVERSAL TERMINAL



Υλικό / Material: **Αλουμίνιο & PVC / Aluminium & PVC**



CODE	BARCODE	COLOR	PACKING	MOQ	PRICE (€)
145-59210	5207227264054	WHITE	1/1	1	0,65
145-59230	5207227264153	BLACK	1/1	1	0,65

ΑΝΤΑΠΤΟΡΑΣ ΓΙΑ ΚΑΛΩΔΙΟ

ADAPTOR FOR CABLE



82x31x82mm

Σύνδεση / Connection: **Κλέμμα / Terminal Block**

Υλικό / Material: **Αλουμίνιο & PVC / Aluminium & PVC**



CODE	BARCODE	COLOR	PACKING	MOQ	PRICE (€)
145-59209	5207227264054	WHITE	1/100	1	9,25
145-59229	5207227220333	BLACK	1/100	1	9,25

ΑΝΤΑΠΤΟΡΑΣ ΜΕ ΚΑΛΩΔΙΟ 2Μ

ADAPTOR WITH CABLE



82x31x82mm

Σύνδεση / Connection: **Κλέμμα / Terminal Block**

Υλικό / Material: **Αλουμίνιο & PVC / Aluminium & PVC**

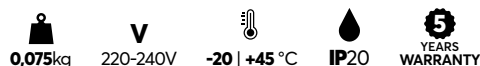

CODE	BARCODE	COLOR	PACKING	MOQ	PRICE (€)
145-59212	5207227158537	WHITE	1/100	1	14,35
145-59232	5207227158551	BLACK	1/100	1	14,35

ΣΥΝΔΕΣΜΟΣ UNIVERSAL ΕΥΘΕΙΑΣ ΜΕ ΤΡΟΦΟΔΟΣΙΑ

CONJUNCTION UNIVERSAL STRAIGHT WITH POWER SUPPLY



Υλικό / Material: **Αλουμίνιο & PVC / Aluminium & PVC**



CODE	BARCODE	COLOR	PACKING	MOQ	PRICE (€)
145-59214	5207227264078	WHITE	1/1	1	9,85
145-59234	5207227264160	BLACK	1/1	1	9,85

ΝΤΙΖΑ ΦΩΤΙΣΤΙΚΟΥ ΜΕ ΡΟΖΕΤΑ 2Μ (4Ρ)

SUSPENDING WIRE FOR LIGHT FIXTURE WITH ROSETTE 2M (4P)



Υλικό / Material: **Αλουμίνιο & PVC / Aluminium & PVC**



CODE	BARCODE	COLOR	PACKING	MOQ	PRICE (€)
145-59211	5207227153983	WHITE	1/100	1	14,65
145-59231	5207227153990	BLACK	1/100	1	14,65

Φωτιστικά Πάγκου & εσωτερικού χώρου

Lighting LED fixtures
indoor use



ΦΩΤΙΣΤΙΚΟ ΠΑΓΚΟΥ LED ΜΕ ΑΝΙΧΝΕΥΤΗ ΚΙΝΗΣΗΣ LIGHTING LED FIXTURE WITH MOTION SENSOR

220x45x25mm

Γωνία Δέσμης Φωτός / Beam Angle: Horizontal **120°**, Vertical **60°**
 Ενεργειακή Κλάση / Energy Class: **F**
 Start Time: **0,5sec** • PF > **0,50** • CRI > **80**
 Τύπος ανίχνευσης / Detection type: **PIR & CDS**
 Απόσταση ανίχνευσης / Detection distance: **3m**
 Μπαταρίες / Batteries: **4xAA 1,5V**
 Υλικό / Material: **Πλαστικό & ABS / Plastic & ABS**



-20 | +50 °C
 MOTION SENSOR
 AUTO ON/OFF
 NON DIMMABLE
 0,110kg
 15.000h
 ON OFF 10.000
 IP20
 2 YEARS WARRANTY

CODE	BARCODE	WATT	KELVIN	LUMEN/WATT	COLOR	PACKING	MOQ	PRICE (€)
145-55320	5207227150418	3	3000	73,3	WHITE	1/60	1	9,20

190x30x15mm

Γωνία Δέσμης Φωτός / Beam Angle: Horizontal **120°**, Vertical **60°**
 Ενεργειακή Κλάση / Energy Class: **G**
 Start Time: **0,5sec** • PF > **0,50** • CRI > **80**
 Τύπος ανίχνευσης / Detection type: **PIR & CDS**
 Απόσταση ανίχνευσης / Detection distance: **3m**
 Μπαταρίες / Batteries: **3xAAA 1,5V**
 Υλικό / Material: **Πλαστικό & ABS / Plastic & ABS**



-20 | +50 °C
 MOTION SENSOR
 AUTO ON/OFF
 NON DIMMABLE
 0,050kg
 15.000h
 ON OFF 10.000
 IP20
 2 YEARS WARRANTY

CODE	BARCODE	WATT	KELVIN	LUMEN/WATT	COLOR	PACKING	MOQ	PRICE (€)
145-55322	5207227150425	1,5	3000	53,3	WHITE	1/60	1	7,60

Ø70x30mm

Γωνία Δέσμης Φωτός / Beam Angle: Horizontal **120°**, Vertical **60°**
 Ενεργειακή Κλάση / Energy Class: **F**
 Start Time: **0,5sec** • PF > **0,50** • CRI > **80**
 Τύπος ανίχνευσης / Detection type: **PIR & CDS**
 Απόσταση ανίχνευσης / Detection distance: **3m**
 Μπαταρίες / Batteries: **3xAAA 1,5V**
 Υλικό / Material: **Πλαστικό & ABS / Plastic & ABS**



-20 | +50 °C
 MOTION SENSOR
 AUTO ON/OFF
 NON DIMMABLE
 0,048kg
 15.000h
 ON OFF 10.000
 IP20
 2 YEARS WARRANTY

CODE	BARCODE	WATT	KELVIN	LUMEN/WATT	COLOR	PACKING	MOQ	PRICE (€)
145-55324	5207227150449	1	3000	60	WHITE	1/60	1	7,60

ΦΩΤΙΣΤΙΚΟ ΠΑΓΚΟΥ LED ΜΕ ΔΙΑΚΟΠΗ LIGHTING LED FIXTURE WITH SWITCH

200x33x20mm

Γωνία Δέσμης Φωτός / Beam Angle: Horizontal **120°**, Vertical **60°**

Ενεργειακή Κλάση / Energy Class: **G**

Start Time: **0,5sec** • PF > **0,50** • CRI > **80**

Τύπος ανίχνευσης / Detection type: **PIR & CDS**

Μπαταρίες / Batteries: **3xAAA 1,5V**

Υλικό / Material: **Πλαστικό & ABS / Plastic & ABS**



 **-20 | +50 °C** **SWITCH** ON/OFF  **NON DIMMABLE**  **0,064kg**  **15.000h** **ON OFF** 10.000  **IP20**  **2 YEARS WARRANTY**

CODE	BARCODE	WATT	KELVIN	LUMEN/WATT	COLOR	PACKING	MOQ	PRICE (€)
145-55323	5207227150432	2	3000	53,3	WHITE	1/60	1	3,75



ΦΩΤΙΣΤΙΚΑ ΠΑΓΚΟΥ LED LIGHTING LED TUBE FIXTURE

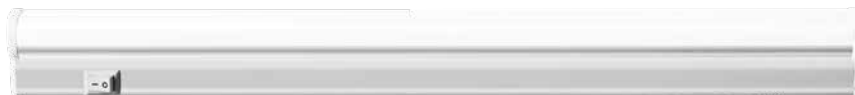

Volt: **85-265V 50/60Hz** • LED Type: **SMD2835**

Γωνία Δέσμης Φωτός / Beam Angle: **160°**

Ενεργειακή Κλάση / Energy Class: **F**

Start Time: **0,5sec** • PF > **0,70** • CRI > **80**

Υλικό / Material: **PC**

Σύνδεση / Connection: **Καλώδιο με φικς / Wire with plug**

-20 | +40 °C

CLASS I

NON DIMMABLE

COLOR WHITE

Lm/W 100

25.000h

ON OFF 15.000

IP20

2 YEARS WARRANTY

0-1,5m
INSTALLATION HEIGHT

CODE	BARCODE	WATT	KELVIN	AMPERAGE	DIMENSIONS	WEIGHT	PACKING	MOQ	PRICE (€)
147-55300	5207227122743	4	6500	50mA	304x36x22mm	0,160kg	1/30	1	6,65
147-55301	5207227111273	4	4000	50mA	304x36x22mm	0,160kg	1/30	1	6,65
147-55303	5207227111297	8	6500	75mA	574x36x22mm	0,190kg	1/30	1	8,55
147-55304	5207227111310	8	4000	75mA	574x36x22mm	0,190kg	1/30	1	8,55
147-55306	5207227111334	12	6500	85mA	874x36x22mm	0,240kg	1/30	1	10,45
147-55307	5207227111358	12	4000	85mA	874x36x22mm	0,240kg	1/30	1	10,45
147-55309	5207227111372	16	6500	105mA	1184x36x22mm	0,390kg	1/30	1	11,55
147-55310	5207227111396	16	4000	105mA	1184x36x22mm	0,390kg	1/30	1	11,55
147-55312	5207227111419	20	6500	120mA	1474x36x22mm	0,490kg	1/30	1	14,65
147-55313	5207227111433	20	4000	120mA	1474x36x22mm	0,490kg	1/30	1	14,65

ΦΩΤΙΣΤΙΚΑ ΚΛΕΙΣΤΟΥ ΤΥΠΟΥ ΜΕ ΤΑΙΝΙΕΣ LED CLOSED TYPE LIGHTS WITH LED TAPES



3 CCT

NEW



Volt: **200-240V 50/60Hz** • LED Type: **SMD2835**

Γωνία Δέσμης Φωτός / Beam Angle: **120°**

Ενεργειακή Κλάση / Energy Class: **E**

3CCT: **3000K/4000K/6500K**

Start Time: **1,0sec** • CRI > **80**

Υλικό / Material: **Αλουμίνιο & Πλαστικό / Aluminium & Plastic**

Σύνδεση / Connection: **Καλώδιο / Wire**

-15 | +55 °C

NON DIMMABLE

COLOR WHITE

Lm/W 120

25.000h

ON OFF 15.000

IP20

3 YEARS WARRANTY

4-5m
INSTALLATION HEIGHT

CODE	OLD CODE	BARCODE	WATT	KELVIN	DIMENSIONS	PF	WEIGHT	PACKING	MOQ	PRICE (€)
147-55320	-	5207227288425	9	3CCT	320x75x25mm	>0,70	0,145kg	1/30	1	8,35
147-55321	147-55350 *	5207227288449	18	3CCT	620x75x25mm	>0,70	0,250kg	1/30	1	9,85
147-55322	-	5207227288463	27	3CCT	920x75x25mm	>0,90	0,335kg	1/30	1	11,55
147-55323	147-55352 *	5207227288487	36	3CCT	1220x75x25mm	>0,90	0,460kg	1/30	1	13,55
147-55324	-	5207227288500	45	3CCT	1520x75x25mm	>0,90	0,575kg	1/30	1	16,85

* ΔΙΑΘΕΣΙΜΟ ΜΕΧΡΙ ΕΞΑΝΤΗΣΕΩΣ ΤΩΝ ΑΠΟΘΕΜΑΤΩΝ / AVAILABLE WHILE STOCKS LAST

ΦΩΤΙΣΤΙΚΑ ΚΕΝΑ SLIM ΓΙΑ LED TUBE BATTEN LUMINAIRES EMPTY SLIM FOR LED TUBE



ΤΡΟΦΟΔΟΣΙΑ 1 ΑΚΡΟΥ 1-SIDE POWER



Volt: **80-270V 50/60Hz**

Γωνία Δέσμης Φωτός / Beam Angle: **120°**

Υλικό / Material: **Σίδηρος / Iron**

Σύνδεση / Connection: **Καλώδιο / Wire**

T8
TYPE

G13
BASE



-20 | +50 °C

COLOR
WHITE



2
YEARS
WARRANTY



CODE	BARCODE	WATT	DIMENSIONS	WEIGHT	PACKING	MOQ	PRICE (€)
147-56550	5207227018725	max 9W	600x35x18mm	0,134kg	1/50	1	2,15
147-56551	5207227018749	max 18W	1200x32x16mm	0,240kg	1/25	1	2,55
147-56556	5207227031595	max 24W	1500x30x45mm	0,273kg	1/50	1	4,15
147-56553	5207227018763	max 2x9W	600x40x200mm	0,205kg	1/32	1	2,45
147-56554	5207227018787	max 2x18W	1200x45x25mm	0,354kg	1/25	1	3,20
147-56557	5207227031625	max 2x24W	1500x75x48mm	0,300kg	1/32	1	5,45

ΤΡΟΦΟΔΟΣΙΑ 2 ΑΚΡΩΝ 2-SIDE POWER

CODE	BARCODE	WATT	DIMENSIONS	WEIGHT	PACKING	MOQ	PRICE (€)
147-56560	5207227288777	max 10W	610x34x15mm	0,315kg	1/25	1	2,15
147-56561	5207227288791	max 18W	1200x34x15mm	0,190kg	1/25	1	2,55
147-56562	5207227288814	max 24W	1500x34x15mm	0,250kg	1/25	1	4,15
147-56563	5207227288838	max 2x10W	610x34x15mm	0,260kg	1/25	1	2,45
147-56564	5207227288852	max 2x18W	1200x34x15mm	0,390kg	1/25	1	3,20
147-56565	5207227288876	max 2x24W	1500x34x15mm	0,450kg	1/25	1	5,45

ΦΩΤΙΣΤΙΚΑ ΚΕΝΑ ΓΙΑ LED TUBE BATTEN LUMINAIRES EMPTY FOR LED TUBE



ΟΒΑΛ OVAL

Volt: **80-270V 50/60Hz**

Γωνία Δέσμης Φωτός / Beam Angle: **120°**

Υλικό / Material: **Σίδηρος & Πλαστικό / Iron & Plastic**

Σύνδεση / Connection: **Καλώδιο / Wire**

T8
TYPE

G13
BASE



-20 | +50 °C

COLOR
WHITE



2
YEARS
WARRANTY



CODE	BARCODE	WATT	DIMENSIONS	WEIGHT	PACKING	MOQ	PRICE (€)
147-56020	5207227004124	max 2x9W	600x130x45mm	0,500kg	1/12	1	10,95
147-56021	5207227004148	max 2x18W	1200x125x42mm	0,907kg	1/10	1	12,15

ΟΒΑΛ ΜΕ ΓΡΙΛΙΕΣ OVAL WITH GRILLES

CODE	BARCODE	WATT	DIMENSIONS	WEIGHT	PACKING	MOQ	PRICE (€)
147-56022	5207227004162	max 2x9W	600x130x45mm	0,513kg	1/12	1	10,95
147-56023	5207227004186	max 2x18W	1200x125x42mm	0,911kg	1/10	1	12,15

ΦΩΤΙΣΤΙΚΟ ΟΡΟΦΗΣ ΦΘΟΡΙΟΥ ΚΥΚΛΙΚΟ CEILING LIGHT FLUORESCENT ROUND



Volt: **220-240V 50/60Hz**

Υλικό / Material: **Μεταλλικό / Metallic**

Σύνδεση / Connection: **Κλέμμα / Terminal Block**

T9
TYPE

G10Q
BASE



-20 | +50 °C

COLOR
WHITE



2
YEARS
WARRANTY



CODE	BARCODE	WATT	AMPERAGE	DIMENSIONS	WEIGHT	PACKING	MOQ	PRICE (€)
147-56050	5207227073816	32	430mA	Φ340x35mm	0,982kg	1/2	1	22,55



Volt: **220-240V 50/60Hz**

Υλικό / Material: **Μεταλλικό / Metallic**

Σύνδεση / Connection: **Κλέμμα / Terminal Block**

T9
TYPE

G10Q
BASE



-20 | +50 °C

COLOR
WHITE



2
YEARS
WARRANTY

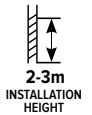

CODE	BARCODE	WATT	AMPERAGE	DIMENSIONS	WEIGHT	PACKING	MOQ	PRICE (€)
147-56051	5206139470515	40	430mA	Φ340x35mm	0,982kg	1/2	1	22,55



Volt: **220-240V 50/60Hz**

Υλικό / Material: **Μεταλλικό / Metallic**

Σύνδεση / Connection: **Κλέμμα / Terminal Block**

T9
TYPE

G10Q
BASE



-20 | +50 °C

COLOR
WHITE



2
YEARS
WARRANTY

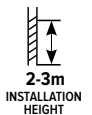

CODE	BARCODE	WATT	AMPERAGE	DIMENSIONS	WEIGHT	PACKING	MOQ	PRICE (€)
147-56052	5206139470522	72	430mA	Φ340x35mm	0,982kg	1/2	1	30,45

Φωτιστικά γραμμικά LED επαγγελματικής χρήσης

LED Linear Lighting
for professional use

The complete solution
on waterproof LED luminaires

Η ολοκληρωμένη λύση στα στεγανά φωτιστικά

Τα στεγανά φωτιστικά της EUROLAMP είναι η ασφαλής επένδυση για τον φωτισμό επαγγελματικών χώρων. Κατασκευή που αντέχει στις πιο δύσκολες προκλήσεις και απίστευτη ευελιξία!

EUROLAMP waterproof luminaires are the safe investment for the lighting of business spaces. Construction that withstands the toughest challenges and incredible flexibility!

- ▶ Ένα φωτιστικό, πολλαπλές λύσεις συνδυαστικά. Διαχείριση θερμοκρασίας χρώματος 3CCT. Επιλογή τριών διαφορετικών λειτουργιών ισχύος (W) και εκδόσεις με προσθήκη λειτουργίας ανιχνευτή κίνησης ή λειτουργία εφεδρικού φωτισμού.

One luminaires, multiple solutions combined. 3CCT color temperature management. Choice of three different operating power modes (wattage) and versions with motion detector function or backup lighting function.

- ▶ Υψηλή απόδοση φωτεινότητας από 140 έως 160 lumens για κάθε Watt ισχύος ανάλογα το μοντέλο.

Incomparable brightness output in proportion to consumption with performance 180Lm/W



ΦΩΤΙΣΤΙΚΟ ΓΡΑΜΜΙΚΟ LED SLIM LINEAR LIGHT FIXTURE LED SLIM



Volt: **220-240V 50/60Hz**

Ενεργειακή Κλάση / Energy Class: **F**

Γωνία Δέσμης Φωτός / Beam Angle: **120°**

LED Type: **SMD2835**

Start Time: **0,5sec** • PF > **0,90** • CRI > **80** • IK **08**

Υλικό / Material: **Πλαστικό / Plastic**

Λευκή Βάση - Γαλακτούχο Κάλυμμα / White Base - Milky Cover

Με 2 Στυπιοθήλιπτες / With 2 cable glands

Σύνδεση / Connection: **Τροφοδοσία & από τις 2 πλευρές / 2 Way Connection**



CODE	BARCODE	WATT	KELVIN	LUMEN/W	AMPERAGE	DIMENSIONS	WEIGHT	PACKING	MOQ	PRICE (€)
147-56610	5207227068249	18	6500	100	80mA	640x58x37mm	0,150kg	1/20	1	12,65
147-56611	5207227068263	18	4000	100	80mA	640x58x37mm	0,150kg	1/20	1	12,65
147-56613	5207227068287	36	6500	100	162mA	1280x55x35mm	0,300kg	1/24	1	16,35
147-56614	5207227068300	36	4000	100	162mA	1280x55x35mm	0,300kg	1/24	1	16,35
147-56616	5207227068324	45	6500	100	205mA	1580x55x35mm	0,400kg	1/24	1	23,15
147-56617	5207227068348	45	4000	100	205mA	1540x55x35mm	0,400kg	1/24	1	23,15

ΦΩΤΙΣΤΙΚΟ ΓΡΑΜΜΙΚΟ LED SLIM NANO PC LINEAR LIGHT FIXTURE LED SLIM NANO PC



Volt: **220-240V 50/60Hz** • LED Type: **SMD2835**

Ενεργειακή Κλάση / Energy Class: **F**

Γωνία Δέσμης Φωτός / Beam Angle: **120°**

Start Time: **0,5sec** • PF > **0,90** • CRI > **80** • IK **06**

Υλικό / Material: **Nano PC**

Γαλακτούχο Κάλυμμα / Milky Cover

Με 2 Στυπιοθήλιπτες / With 2 cable glands

Σύνδεση / Connection: **Τροφοδοσία & από τις 2 πλευρές / 2 Way Connection**



CODE	BARCODE	WATT	LUMEN	KELVIN	AMPERAGE	DIMENSIONS	WEIGHT	PACKING	MOQ	PRICE (€)
147-56620	5207227068362	18	1800	6500	80mA	625x43x33mm	0,23kg	1/24	1	14,65
147-56621	5207227068386	18	1800	4000	80mA	625x43x33mm	0,23kg	1/24	1	14,65
147-56622	5207227071881	18	1800	3000	80mA	625x43x33mm	0,23kg	1/24	1	14,65
147-56623	5207227068409	24	2400	6500	109mA	1225x43x33mm	0,35kg	1/24	1	21,25
147-56624	5207227068423	24	2400	4000	109mA	1225x43x33mm	0,35kg	1/24	1	21,25
147-56625	5207227071898	24	2400	3000	109mA	1225x43x33mm	0,35kg	1/24	1	21,25
147-56626	5207227068447	36	3600	6500	162mA	1525x43x33mm	0,43kg	1/24	1	25,85
147-56627	5207227068461	36	3600	4000	162mA	1525x43x33mm	0,43kg	1/24	1	25,85
147-56628	5207227071904	36	3600	3000	162mA	1525x43x33mm	0,43kg	1/24	1	25,85

ΦΩΤΙΣΤΙΚΟ ΓΡΑΜΜΙΚΟ ΣΤΕΓΑΝΟ LED LINEAR LUMINAIRE WATERPROOF LIGHT

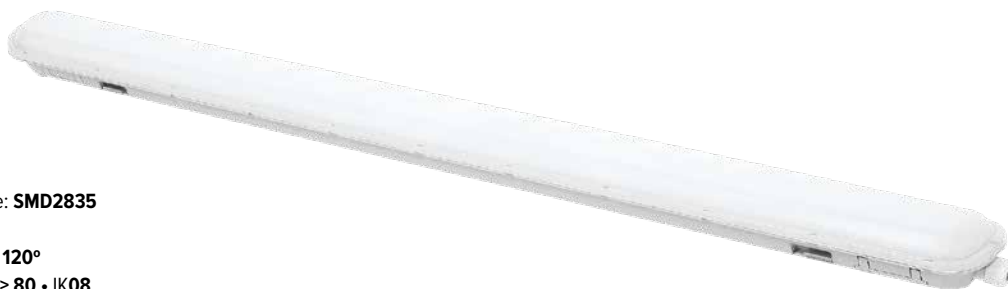

Volt: **220-240V 50/60Hz** • LED Type: **SMD2835**

Ενεργειακή Κλάση / Energy Class: **E**

Γωνία Δέσμης Φωτός / Beam Angle: **120°**

Start Time: **0,5sec** • PF > **0,90** • CRI > **80** • IK08

Υλικό / Material: **Πλαστικό / Plastic**

Γκρι Βάση - Γαλακτούχο Κάλυμμα / Grey Base - Milky Cover

Με 2 Στυπιοθήλιδες / With 2 cable glands

Σύνδεση / Connection: **Τροφοδοσία & από τις 2 πλευρές / 2 Way Connection**

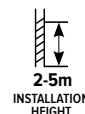

CODE	BARCODE	WATT	LUMEN	KELVIN	AMPERAGE	DIMENSIONS	WEIGHT	PACKING	MOQ	PRICE (€)
147-56600	5207227059568	24	2880	4000	165mA	600x92x60mm	0,8kg	1/15	1	21,25
147-56601	5207227069864	24	2880	5700	165mA	600x92x60mm	0,8kg	1/15	1	21,25
147-56603	5207227059582	48	5760	4000	216mA	1200x92x60mm	1,5kg	1/8	1	43,35
147-56604	5207227069871	48	5760	5700	216mA	1200x92x60mm	1,5kg	1/8	1	43,35
147-56606	5207227059605	56	6720	4000	243mA	1500x92x60mm	1,8kg	1/8	1	51,20
147-56607	5207227069888	56	6720	5700	243mA	1500x92x60mm	1,8kg	1/8	1	51,20

ΦΩΤΙΣΤΙΚΟ ΓΡΑΜΜΙΚΟ LED SLIM ΜΕ ΑΝΙΧΝΕΥΤΗ ΚΙΝΗΣΗΣ LINEAR LIGHT FIXTURE LED SLIM WITH MOVEMENT SENSOR



Volt: **220-240V 50/60Hz**

Ενεργειακή Κλάση / Energy Class: **E**

Γωνία Δέσμης Φωτός / Beam Angle: **120°**

LED Type: **SMD2835**

Start Time: **0,5sec** • PF > **0,90** • CRI > **80** • IK 08

Υλικό / Material: **Αλουμίνιο & Πλαστικό / Aluminium & Plastic**

Μαύρη Βάση - Γαλακτούχο Κάλυμμα / Black Base - Milky Cover

Με 2 Στυπιοθήλιδες / With 2 cable glands

Σύνδεση / Connection: **Τροφοδοσία & από τις 2 πλευρές / 2 Way Connection**



CODE	BARCODE	WATT	KELVIN	LUMEN/W	AMPERAGE	DIMENSIONS	WEIGHT	PACKING	MOQ	PRICE (€)
147-56633	5207227119132	40	6500	125	220mA	1225x74x67mm	1,600kg	1/6	1	55,25
147-56634	5207227119149	40	4000	125	220mA	1225x74x67mm	1,600kg	1/6	1	55,25
147-56636	5207227119156	60	6500	125	330mA	1525x74x67mm	2,000kg	1/6	1	65,55
147-56637	5207227119163	60	4000	125	330mA	1525x74x67mm	2,000kg	1/6	1	65,55

ΦΩΤΙΣΤΙΚΟ ΣΤΕΓΑΝΟ ΓΙΑ LED TUBE LUMINAIRE WATERPROOF FOR LED TUBE



Volt: **80-270V 50/60Hz**

Γωνία Δέσμης Φωτός / Beam Angle: **180°**

Υλικό / Material: **Πλαστικό / Plastic**

Σύνδεση / Connection: **Τροφοδοσία & από τις 2 πλευρές / 2 Way Connection**

T8
TYPE

G13
BASE



GROUNDING



-20 | +50 °C

COLOR
GREY



IP65



2
YEARS
WARRANTY

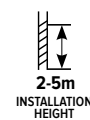

CODE	BARCODE	WATT	DIMENSIONS	WEIGHT	PACKING	MOQ	PRICE (€)
147-56060	5206139084279	max 9W	670x68x74mm	0,670kg	1/6	1	12,65
147-56061	5206139084293	max 18W	1270x68x74mm	1,200kg	1/6	1	19,45
147-56062	5206139084309	max 24W	1570x68x74mm	1,500kg	1/6	1	23,55
147-56063	5206139084316	max 2x9W	670x104x74mm	0,950kg	1/6	1	12,25
147-56064	5206139084323	max 2x18W	1270x104x74mm	1,520kg	1/6	1	23,45
147-56065	5206139078131	max 2x24W	1570x104x74mm	1,900kg	1/6	1	29,25



ΦΩΤΙΣΤΙΚΟ ΣΤΕΓΑΝΟ ΜΕ LED TUBE LUMINAIRE WATERPROOF WITH LED TUBE



Volt: **175-265V 50/60Hz**

Ενεργειακή Κλάση / Energy Class: **E**

Γωνία Δέσμης Φωτός / Beam Angle: **300°**

LED Type: **SMD2835**

Start Time: **0,5sec** • PF > **0,50** • CRI > **80** • IK **08**

Υλικό / Material: **Γυαλί & πλαστική βάση / Glass & plastic base**

Διάφανο κάλυμμα & Γαλακτώδη Λευκή βάση / Transparent Cover & Milky White base

Σύνδεση / Connection: **Τροφοδοσία & από τις 2 πλευρές / 2 Way Connection**

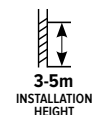

CODE	BARCODE	WATT	KELVIN	LUMEN/W	DIMENSIONS	WEIGHT	PACKING	MOQ	PRICE (€)
147-56070	5207227274824	18	4000	110	1272x66x73mm	1,19kg	1/8	1	21,85
147-56071	5207227274848	36	4000	110	1272x102x73mm	1,83kg	1/10	1	28,85
147-56072	5207227274862	24	4000	110	1572x66x73mm	1,48kg	1/10	1	25,65
147-56073	5207227275494	48	4000	110	1572x102x73mm	2,17kg	1/9	1	35,85

ΕΚΘΕΤΗΡΙΟ ΓΙΑ ΣΤΕΓΑΝΑ ΦΩΤΙΣΤΙΚΑ ΜΕ LED TUBE 1,20m & 1,50m

DISPLAY
FOR WATERPROOF LUMINAIRE
WITH LED TUBE
1,20m & 1,50m



ΔΙΑΣΤΑΣΕΙΣ / DIMENSIONS	ΤΕΜΑΧΙΑ / PCS
1x1,2m	110pcs
2x1,2m	70pcs
1x1,5m	110pcs
2x1,5m	70pcs

CODE	BARCODE	DIMENSIONS	WEIGHT	PACKING	MOQ	PRICE (€)
147-56078	5207227275500	For Display 1,20m - 1340x820x880mm	1,48kg	1/10	1	26,25
147-56079	5207227275517	For Display 1,50m - 1610x740x1090mm	2,17kg	1/9	1	30,10

ΦΩΤΙΣΤΙΚΟ ΓΡΑΜΜΙΚΟ ΣΤΕΓΑΝΟ LED LUMINAIRE WATERPROOF LED LIGHT



Wattage 3 options

Volt: **220-240V 50/60Hz** • LED Type: **SMD2835**

3CCT: **3000K/4000K/6000K**

Ενεργειακή Κλάση / Energy Class: **D**

Γωνία Δέσμης Φωτός / Beam Angle: **120°**

Start Time: **0,5sec** • PF > **0.90** • CRI > **80** • IK08

Υλικό / Material: **Πολυκαρβονικό / Polycarbonate**

Με διακόπτη επιλογής / DIP switch

Γκρι Βάση - Γαλακτούχο Κάλυμμα / Grey Base - Milky Cover

Σύνδεση / Connection: **Τροφοδοσία & από τις 2 πλευρές /**

2 Way Connection

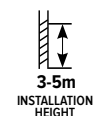

CODE	BARCODE	WATT	KELVIN	AMPERAGE	DIMENSIONS	WEIGHT	PACKING	MOQ	PRICE (€)
147-56660	5207227302411	10/15/20	3CCT	50-80-100mA	600x80x72mm	0,85kg	1/9	1	48,35
147-56661	5207227274541	20/30/40	3CCT	106-160-205mA	1200x80x72mm	1,90kg	1/9	1	64,45
147-56662	5207227274565	30/40/50	3CCT	116-159-197mA	1500x80x72mm	2,15kg	1/9	1	87,85

ΦΩΤΙΣΤΙΚΟ ΓΡΑΜΜΙΚΟ ΣΤΕΓΑΝΟ ΜΕ ΑΝΙΧΝΕΥΤΗ ΚΙΝΗΣΗΣ LED LUMINAIRE WATERPROOF WITH MOVEMENT DETECTOR LED



Wattage 3 options

Volt: **220-240V 50/60Hz** • LED Type: **SMD2835**

3CCT: **3000K/4000K/6000K**

Ενεργειακή Κλάση / Energy Class: **D**

Γωνία Δέσμης Φωτός / Beam Angle: **120°**

Start Time: **0,5sec** • PF > **0.90** • CRI > **80** • IK08

Υλικό / Material: **Πολυκαρβονικό / Polycarbonate**

Με διακόπτη επιλογής / DIP switch

Γκρι Βάση - Γαλακτούχο Κάλυμμα / Grey Base - Milky Cover

Σύνδεση / Connection: **Τροφοδοσία & από τις 2 πλευρές /**

2 Way Connection



Απόσταση Ανίχνευσης / Detection Distance: **12m**



CODE	BARCODE	WATT	KELVIN	AMPERAGE	DIMENSIONS	WEIGHT	PACKING	MOQ	PRICE (€)
147-56675	5207227302244	10/15/20	3CCT	50-80-100mA	600x80x72mm	1.10kg	1/9	1	69,45
147-56676	5207227274589	20/30/40	3CCT	106-160-205mA	1200x80x72mm	1.91kg	1/9	1	85,15

ΦΩΤΙΣΤΙΚΟ ΓΡΑΜΜΙΚΟ ΣΤΕΓΑΝΟ ΜΕ ΕΦΕΔΡΕΙΑ LED LUMINAIRE WATERPROOF WITH EMERGENCY LIGHT LED



Wattage 3 options

Volt: **220-240V 50/60Hz** • LED Type: **SMD2835**

3CCT: **3000K/4000K/6000K**

Ενεργειακή Κλάση / Energy Class: **D**

Γωνία Δέσμης Φωτός / Beam Angle: **120°**

Start Time: **0,5sec** • PF > **0.90** • CRI > **80** • IK08

Υλικό / Material: **Πολυκαρβονικό / Polycarbonate**

Με διακόπτη επιλογής / DIP switch

Γκρι Βάση - Γαλακτώχο Κάλυμμα / Grey Base - Milky Cover

Σύνδεση / Connection: **Τροφοδοσία & από τις 2 πλευρές / 2 Way Connection**

Τύπος Μπαταρίας / Battery type: **Lithium 2000mAh**

Χρόνος φόρτισης / Battery Charging Time: **>24h**

Discharging Time: **3h, 450lm**



CODE	BARCODE	WATT	KELVIN	AMPERAGE	DIMENSIONS	WEIGHT	PACKING	MOQ	PRICE (€)
147-56670	5207227302237	10/15/20	3CCT	50-80-100mA	600x80x72mm	0.85kg	1/9	1	151,60
147-56671	5207227274602	20/30/40	3CCT	106-160-205mA	1200x80x72mm	2.15kg	1/9	1	165,30



ΦΩΤΙΣΤΙΚΟ ΓΡΑΜΜΙΚΟ ΣΤΕΓΑΝΟ LED LUMINAIRE WATERPROOF LED LIGHT



Volt: **220-240V 50/60Hz** • LED Type: **SMD2835**
 3CCT: **3000K/4000K/6000K**
 Ενεργειακή Κλάση / Energy Class: **D**
 Γωνία Δέσμης Φωτός / Beam Angle: **120°**
 Start Time: **0,5sec** • PF > **0.90** • CRI > **80** • IK08
 Υλικό / Material: **Πολυκαρβονικό / Polycarbonate**
 Με 2 Στυποθήλιπτες / With 2 cable glands
 Σύνδεση / Connection: **Τροφοδοσία & από τις 2 πλευρές / 2 Way Connection**

-20 | +40 °C
 CLASS I
 NON DIMMABLE
 GROUNDING
 Lm/W **140**
 30.000h
 ON OFF **15.000**
 IP65
 3 YEARS WARRANTY

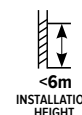

CODE	BARCODE	WATT	KELVIN	AMPERAGE	DIMENSIONS	WEIGHT	PACKING	MOQ	PRICE (€)
147-56640	5207227288890	18	3CCT	210mA	600x80x72mm	0,96kg	1/9	1	28,50
147-56642	5207227288913	36	3CCT	230mA	1200x80x72mm	1,47kg	1/9	1	42,95
147-56644	5207227288937	48	3CCT	300mA	1500x80x72mm	1,80kg	1/9	1	53,65



Volt: **220-240V 50/60Hz** • LED Type: **SMD2835**
 Ενεργειακή Κλάση / Energy Class: **C**
 Γωνία Δέσμης Φωτός / Beam Angle: **120°**
 Start Time: **0,5sec** • PF > **0.90** • CRI > **80** • IK08
 Υλικό / Material: **Πολυκαρβονικό / Polycarbonate**
 Με 2 Στυποθήλιπτες / With 2 cable glands
 Σύνδεση / Connection: **Τροφοδοσία & από τις 2 πλευρές / 2 Way Connection**

-20 | +40 °C
 CLASS I
 NON DIMMABLE
 GROUNDING
 Lm/W **160**
 30.000h
 ON OFF **15.000**
 IP65
 3 YEARS WARRANTY

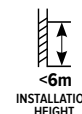

CODE	BARCODE	WATT	KELVIN	AMPERAGE	DIMENSIONS	WEIGHT	PACKING	MOQ	PRICE (€)
147-56653	5207227288951	36	6000	230mA	1200x80x72mm	1,32kg	1/9	1	42,45
147-56654	5207227288975	36	4000	230mA	1200x80x72mm	1,32kg	1/9	1	42,45
147-56656	5207227288999	48	6000	300mA	1500x80x72mm	1,70kg	1/9	1	52,35
147-56657	5207227289019	48	4000	300mA	1500x80x72mm	1,70kg	1/9	1	52,35

ΦΩΤΙΣΤΙΚΟ ΓΡΑΜΜΙΚΟ ΣΤΕΓΑΝΟ ΔΙΑΔΡΟΜΟΥ LED LINEAR LIGHT CORRIDOR TRI-PROOF LED



Volt: **220-240V 50/60Hz** • LED Type: **SMD2835**
 Ενεργειακή Κλάση / Energy Class: **C**
 Γωνία Δέσμης Φωτός / Beam Angle: **40°/100°**
 Start Time: **0,5sec** • PF > **0.95** • CRI > **70** • IK08
 Υλικό / Material: **Αλουμίνιο & PC / Aluminium & PC**
 Χρώμα / Color: **Μαύρο & Κόκκινο / Black & Red**
 Καλώδιο / Wire: **300mm 3x1mm²**

-30 | +45 °C

FLICKER FREE

CLASS I

NON DIMMABLE

GROUNDING

Lm/W 180

50.000h

ON OFF 15.000

IP65

5 YEARS WARRANTY

6-12m INSTALLATION HEIGHT

CODE	BARCODE	WATT	KELVIN	AMPERAGE	DIMENSIONS	WEIGHT	PACKING	MOQ	PRICE (€)
147-56680	5207227302428	50	6000	200mA	385x165x195mm	2,4kg	1/1	1	176,25
147-56681	5207227302497	50	4000	200mA	385x165x195mm	2,4kg	1/1	1	176,25
147-56682	5207227302442	100	6000	420mA	650x165x195mm	3,2kg	1/1	1	226,65
147-56683	5207227302480	100	4000	420mA	650x165x195mm	3,2kg	1/1	1	226,65
147-56684	5207227302435	150	6000	680mA	920x165x195mm	4,3kg	1/1	1	288,35
147-56685	5207227302473	150	4000	680mA	920x165x195mm	4,3kg	1/1	1	288,35
147-56686	5207227302466	200	6000	890mA	1185x165x195mm	5,5kg	1/1	1	366,95
147-56687	5207227302503	200	4000	890mA	1185x165x195mm	5,5kg	1/1	1	366,95

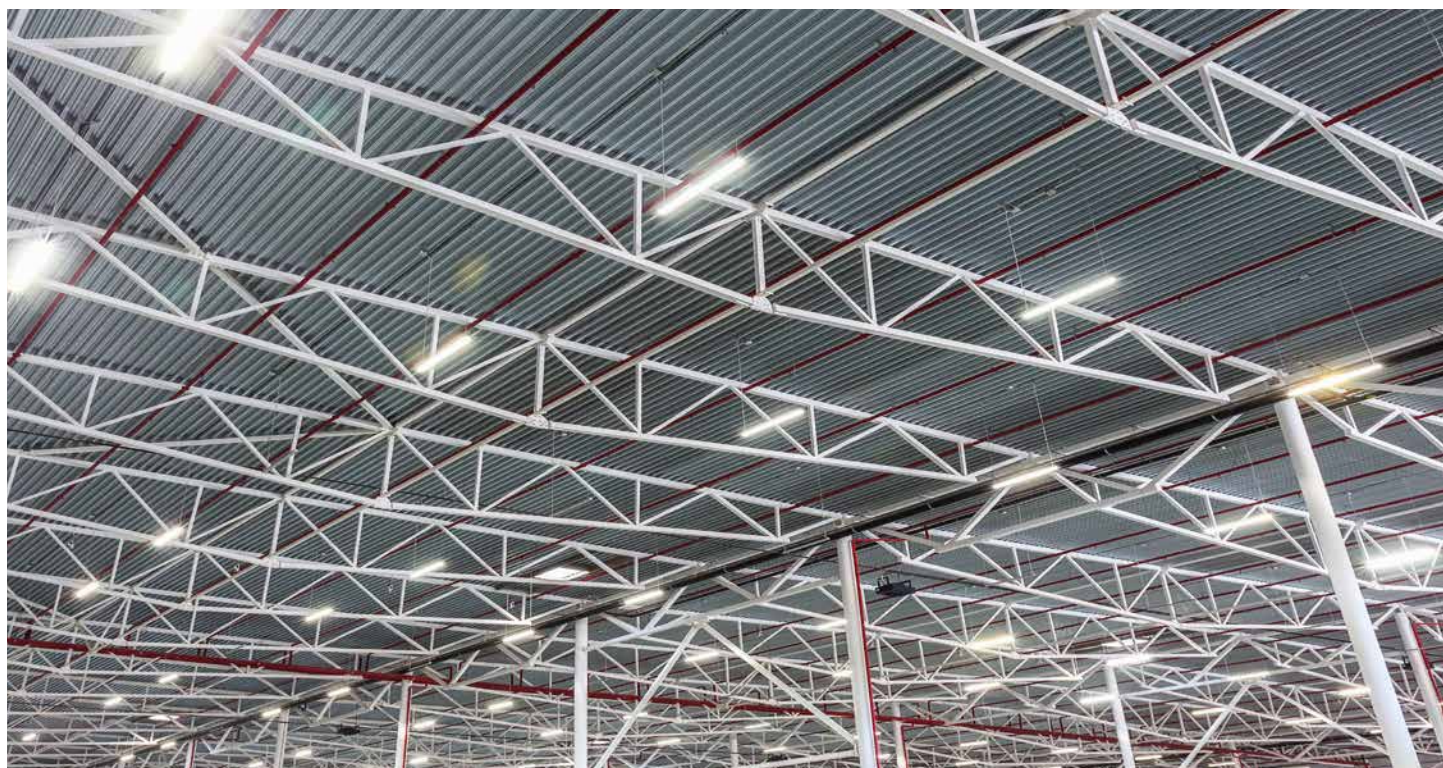

S-LINE FLEX & ΑΞΕΣΟΥΑΡ S-LINE FLEX & ACCESSORIES

ΒΑΣΗ ΓΙΑ ΓΡΑΜΜΙΚΟ ΦΩΤΙΣΤΙΚΟ 8 ΚΑΛΩΔΙΑ S-LINE FLEX BASE FOR LINEAR 8 LINES S-LINE FLEX



Volt: **220-240V 50/60Hz** • LED Type: **SMD2835**

Σύνδεση / Connection: **Κλέμμα / Terminal Block**

Γραμμές / Lines: **1x2,5mm²**

Εφεδρικός / Emergency:

"L" 4x2,5mm² - "L" and "N" 1x2,5mm² -

"PE" 2x2,5mm² - "DALI"

Υλικό / Material: **Αλουμίνιο, Πλαστικό & Χαλκός / Aluminium, Plastic & Copper**

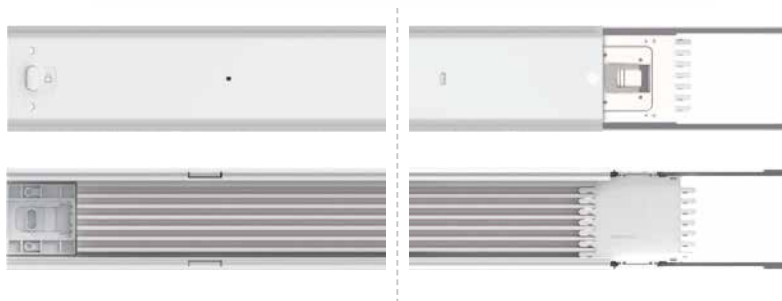
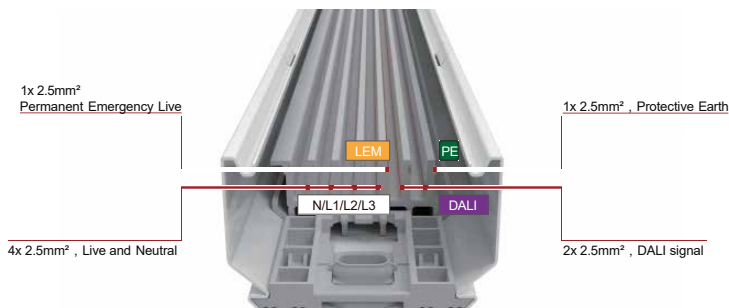

CODE	BARCODE	DIMENSIONS	WEIGHT	COLOR	PACKING	MOQ	PRICE (€)
145-58000	5207227302572	567x65x40mm	1,19kg	WHITE	1/10	1	36,10
145-58001	5207227302541	1129x65x40mm	2,15kg	WHITE	1/10	1	55,65
145-58002	5207227302558	1410x65x40mm	2,63kg	WHITE	1/10	1	61,15
145-58003	5207227302534	2258x65x40mm	4,07kg	WHITE	1/10	1	95,40
145-58004	5207227302596	2820x65x40mm	5,02kg	WHITE	1/10	1	114,40
145-58005	5207227302589	3387x65x40mm	5,99kg	WHITE	1/10	1	138,55
145-58006	5207227302565	4230x65x40mm	7,42kg	WHITE	1/10	1	170,05
145-58007	5207227302527	4516x65x40mm	7,91kg	WHITE	1/10	1	179,40

ΓΡΑΜΜΙΚΟ ΣΠΟΤ LED DALI S-LINE FLEX LINEAR LUMINAIRE SPOT LED DALI S-LINE FLEX



Volt: **220-240V 50/60Hz** • LED Type: **COB**

Ενεργειακή Κλάση / Energy Class: **F**

Γωνία Δέσμης Φωτός / Beam Angle: **15°-55° (adjustable)**

Start Time: **0,5sec** • PF > **0.90** • CRI > **90**

Υλικό / Material: **Αλουμίνιο & Πλαστικό / Aluminium & Plastic**

Σύνδεση / Connection: **Κλέμμα / Terminal block**

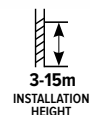

CODE	BARCODE	WATT	KELVIN	AMPERAGE	DIMENSIONS	MAX LENGTH	MAX QUANTITY	WEIGHT	PACKING	MOQ	PRICE (€)
145-58150	5207227302725	32	4000	200mA	567x85x135mm	57m	100pcs	1,6kg	1/4	1	267,75

ΓΡΑΜΜΙΚΟ ΦΩΤΙΣΤΙΚΟ LED DALI S-LINE FLEX LINEAR LUMINAIRE LED DALI S-LINE FLEX



Volt: **220-240V 50/60Hz** • LED Type: **SMD2835**

Ενεργειακή Κλάση / Energy Class: **C**

Γωνία Δέσμης Φωτός / Beam Angle: **60°x90°**

Start Time: **0,5sec** • PF > **0.90** • CRI > **80**

Υλικό / Material: **Αλουμίνιο & Πλαστικό/ Aluminium & Plastic**

Σύνδεση / Connection: **Κλέμμα / Terminal block**

Μέγιστο μήκος ανά κύκλωμα / Max Length per circuit: **113m**

Μέγιστη ποσότητα ανά κύκλωμα / Max Quantity per circuit: **100pcs**

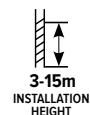

CODE	BARCODE	WATT	KELVIN	AMPERAGE	DIMENSIONS	MAX LENGTH	MAX QUANTITY	WEIGHT	PACKING	MOQ	PRICE (€)
145-58100	5207227302657	32	4000	200mA	1129x65x36mm	113m	100pcs	1,56kg	1/10	1	209,55
145-58101	5207227302671	40	4000	200mA	1129x65x36mm	90m	80pcs	1,56kg	1/10	1	209,55
145-58102	5207227302602	52	4000	300mA	1129x65x36mm	69m	61pcs	1,56kg	1/10	1	209,55
145-58103	5207227302688	60	4000	300mA	1129x65x36mm	60m	53pcs	1,56kg	1/10	1	209,55
145-58104	5207227302619	40	4000	200mA	1410x65x36mm	112m	80pcs	1,95kg	1/10	1	227,15
145-58105	5207227302626	50	4000	300mA	1410x65x36mm	90m	64pcs	1,95kg	1/10	1	227,15
145-58106	5207227302640	65	4000	300mA	1410x65x36mm	70m	50pcs	1,95kg	1/10	1	227,15
145-58107	5207227302664	80	4000	400mA	1410x65x36mm	56m	40pcs	1,95kg	1/10	1	239,50
145-58108	5207227302633	64	4000	300mA	2253x65x36mm	70m	50pcs	3,12kg	1/10	1	301,15
145-58109	5207227302695	80	4000	400mA	2253x65x36mm	90m	40pcs	3,12kg	1/10	1	312,75
145-58110	5207227302701	104	4000	500mA	2253x65x36mm	68m	30pcs	3,12kg	1/10	1	354,95
145-58111	5207227302718	120	4000	600mA	2253x65x36mm	59m	26pcs	3,12kg	1/10	1	363,65

ΓΡΑΜΜΙΚΟ ΦΩΤΙΣΤΙΚΟ LED DALI S-LINE FLEX LINEAR LUMINAIRE LED DALI S-LINE FLEX



Volt: **220-240V 50/60Hz** • LED Type: **SMD2835**

Power Watt: **DIP Adjustable**

Ενεργειακή Κλάση / Energy Class: **E**

Γωνία Δέσμης Φωτός / Beam Angle: **110° (adjustable)**

Start Time: **0,5sec** • PF > **0.90** • CRI > **80**

Υλικό / Material: **Αλουμίνιο & Πλαστικό/ Aluminium & Plastic**

Σύνδεση / Connection: **Κλέμμα / Terminal block**



CODE	BARCODE	WATT	KELVIN	AMPERAGE	DIMENSIONS	WEIGHT	PACKING	MOQ	PRICE (€)
145-58151	5207227302732	30/40/45/50/55/60/65/70/75/80	4000	200-400mA	1129x190x40mm	2,65kg	1/6	1	342,45

ΓΡΑΜΜΙΚΟ ΦΩΤΙΣΤΙΚΟ LED DALI ΜΕ ΕΦΕΔΡΙΚΟ ΦΩΤΙΣΜΟ S-LINE FLEX

LINEAR LUMINAIRE LED DALI WITH EMERGENCY LIGHTING S-LINE FLEX

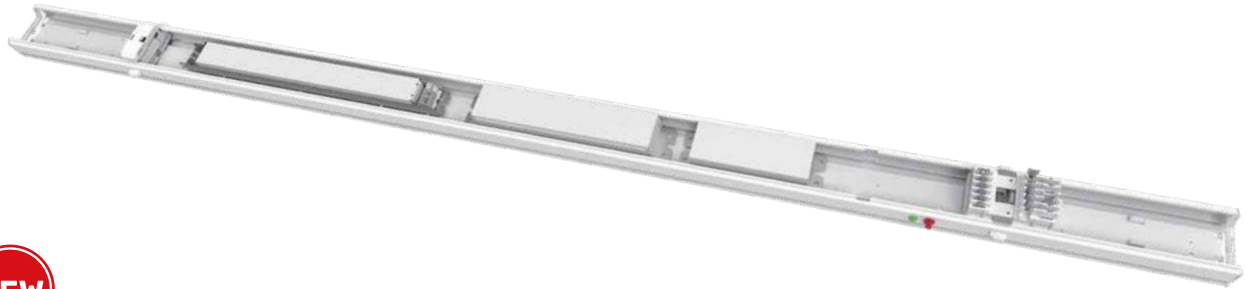

Volt: **220-240V 50/60Hz** • LED Type: **SMD2835**

Εφεδρικός / Emergency: **10W**

Ενεργειακή Κλάση / Energy Class: **C**

Γωνία Δέσμης Φωτός / Beam Angle: **60°x90°**

Start Time: **0,5sec** • PF > **0.90** • CRI > **80**

Υλικό / Material: **Αλουμίνιο & Πλαστικό / Aluminium & Plastic**

Σύνδεση / Connection: **Κλέμμα / Terminal block**

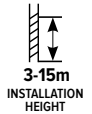
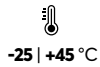

CODE	BARCODE	WATT	KELVIN	AMPERAGE	DIMENSIONS	WEIGHT	PACKING	MOQ	PRICE (€)
145-58170	5207227302749	40	4000	100-400mA	1410x65x36mm	2,5kg	1/10	1	506,95
145-58171	5207227302756	50	4000	100-400mA	1410x65x36mm	2,5kg	1/10	1	506,95
145-58172	5207227302763	65	4000	100-400mA	1410x65x36mm	2,5kg	1/10	1	506,95
145-58173	5207227302770	80	4000	100-400mA	1410x65x36mm	2,5kg	1/10	1	519,45

ΒΑΣΗ ΟΡΟΦΗΣ S-LINE FLEX

CEILING BASE S-LINE FLEX

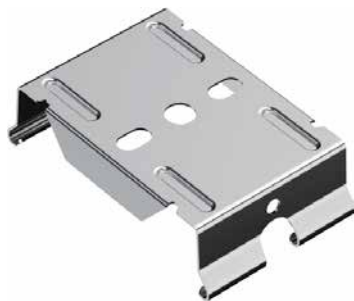

53x36x15mm

Υλικό / Material:

Ανοξείδωτο ατσάλι / Stainless steel



CODE	BARCODE	COLOR	PACKING	MOQ	PRICE (€)
145-58224	5207227302855	GREY	1/10	1	2,18

ΒΑΣΗ ΟΡΟΦΗΣ ΜΕ ΝΤΙΖΑ S-LINE FLEX

CEILING BASE WITH SUSPENDING WIRE S-LINE FLEX



2m x 1.5mm

Υλικό / Material:

Ανοξείδωτο ατσάλι / Stainless steel



CODE	BARCODE	COLOR	PACKING	MOQ	PRICE (€)
145-58225	5207227302992	GREY	1/10	1	6,48

ΤΡΟΦΟΔΟΣΙΑ ΘΗΛΥΚΗ S-LINE FLEX

POWER SUPPLY FEMALE S-LINE FLEX



400x65x60mm

Volt: **220-240V 50/60Hz**

Υλικό / Material:

Αλουμίνιο, Πλαστικό & Χαλκός /

Aluminium, Plastic & Cooper

Σύνδεση / Connection:

Κλέμμα / Terminal block



CLASS I



0,7kg



220-240V



-25 | +45 °C



5 YEARS WARRANTY

CODE	BARCODE	COLOR	PACKING	MOQ	PRICE (€)
145-58200	5207227302879	WHITE	1/10	1	59,20

ΤΡΟΦΟΔΟΣΙΑ ΕΝΔΙΑΜΕΣΗ S-LINE FLEX

POWER SUPPLY INTERMEDIATE S-LINE FLEX



700x65x60mm

Volt: **220-240V 50/60Hz**

Υλικό / Material:

Αλουμίνιο, Πλαστικό & Χαλκός /

Aluminium, Plastic & Cooper

Σύνδεση / Connection:

Κλέμμα / Terminal block



CLASS I



0,95kg



220-240V



-25 | +45 °C



5 YEARS WARRANTY

CODE	BARCODE	COLOR	PACKING	MOQ	PRICE (€)
145-58201	5207227302794	WHITE	1/10	1	95,25

ΤΡΟΦΟΔΟΣΙΑ ΑΡΣΕΝΙΚΗ S-LINE FLEX

POWER SUPPLY MALE S-LINE FLEX



225x65x60mm

Volt: **220-240V 50/60Hz**

Υλικό / Material:

Αλουμίνιο, Πλαστικό & Χαλκός /

Aluminium, Plastic & Cooper

Σύνδεση / Connection:

Κλέμμα / Terminal block



CLASS I



0,65kg



220-240V



-25 | +45 °C



5 YEARS WARRANTY

CODE	BARCODE	COLOR	PACKING	MOQ	PRICE (€)
145-58202	5207227302800	WHITE	1/20	1	59,15

ΚΑΛΥΜΜΑ ΘΗΛΥΚΟ ΓΙΑ ΒΑΣΗ S-LINE FLEX

FEMALE COVER FOR BASE S-LINE FLEX



225x65x60mm

Volt: **220-240V 50/60Hz**

Υλικό / Material:

Αλουμίνιο, Πλαστικό & Χαλκός /

Aluminium, Plastic & Cooper

Σύνδεση / Connection:

Κλέμμα / Terminal block



CLASS I



0,35kg



220-240V



-25 | +45 °C



5 YEARS WARRANTY

CODE	BARCODE	COLOR	PACKING	MOQ	PRICE (€)
145-58203	5207227302831	WHITE	1/40	1	16,45

ΤΕΡΜΑΤΙΚΗ ΤΑΠΑ S-LINE FLEX

TERMINAL S-LINE FLEX



65x76mm

Υλικό / Material: **Πλαστικό / PC**



0,02kg



-25 | +45 °C



5 YEARS WARRANTY

CODE	BARCODE	COLOR	PACKING	MOQ	PRICE (€)
145-58204	5207227302855	WHITE	1/10	1	1,30

ΠΛΑΣΤΙΚΟ ΚΑΛΥΜΜΑ ΓΙΑ ΒΑΣΗ S-LINE FLEX

PLASTIC COVER FOR BASE S-LINE FLEX



1410x65mm

Υλικό / Material: **Πλαστικό / PVC**



0,5kg



-25 | +45 °C



5 YEARS WARRANTY

CODE	BARCODE	COLOR	PACKING	MOQ	PRICE (€)
145-58205	5207227302862	WHITE	1/10	1	10,80

ΣΥΝΔΕΣΜΟΣ ΓΩΝΙΑ ΤΥΠΟΣ "L" S-LINE FLEX CORNER CONNECTOR TYPE "L" S-LINE FLEX

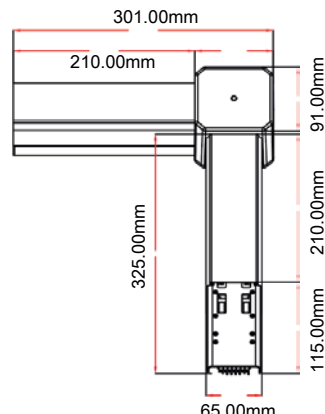

ΤΥΠΟΣ "L" ΑΡΣΕΝΙΚΗ-ΑΡΣΕΝΙΚΗ

TYPE "L" MALE-MALE



301x301x100mm

Volt: **220-240V 50/60Hz**

Υλικό / Material:

Αλουμίνιο, Πλαστικό & Χαλκός / Aluminium, Plastic & Cooper

Σύνδεση / Connection:

Κλέμμα / Terminal block



CODE	BARCODE	COLOR	PACKING	MOQ	PRICE (€)
145-58206	5207227302824	WHITE	1/16	1	102,65

ΤΥΠΟΣ "L" ΘΗΛΥΚΗ-ΘΗΛΥΚΗ

TYPE "L" FEMALE-FEMALE



301x301x100mm

Volt: **220-240V 50/60Hz**

Υλικό / Material:

Αλουμίνιο, Πλαστικό & Χαλκός / Aluminium, Plastic & Cooper

Σύνδεση / Connection:

Κλέμμα / Terminal block



CODE	BARCODE	COLOR	PACKING	MOQ	PRICE (€)
145-58207	5207227302817	WHITE	1/16	1	102,65

ΤΥΠΟΣ "L" ΑΡΙΣΤΕΡΗ ΘΗΛΥΚΗ-ΑΡΣΕΝΙΚΗ

TYPE "L" LEFT FEMALE-MALE



301x301x100mm

Volt: **220-240V 50/60Hz**

Υλικό / Material:

Αλουμίνιο, Πλαστικό & Χαλκός / Aluminium, Plastic & Cooper

Σύνδεση / Connection:

Κλέμμα / Terminal block



CODE	BARCODE	COLOR	PACKING	MOQ	PRICE (€)
145-58208	5207227302848	WHITE	1/16	1	102,65

ΤΥΠΟΣ "L" ΔΕΞΙΑ ΘΗΛΥΚΗ-ΑΡΣΕΝΙΚΗ

TYPE "L" RIGHT FEMALE-MALE



301x301x100mm

Volt: **220-240V 50/60Hz**

Υλικό / Material:

Αλουμίνιο, Πλαστικό & Χαλκός / Aluminium, Plastic & Cooper

Σύνδεση / Connection:

Κλέμμα / Terminal block



CODE	BARCODE	COLOR	PACKING	MOQ	PRICE (€)
145-58209	5207227302787	WHITE	1/16	1	102,65

ΣΥΝΔΕΣΜΟΣ ΤΥΠΟΣ "T" S-LINE FLEX CONNECTOR TYPE "T" S-LINE FLEX

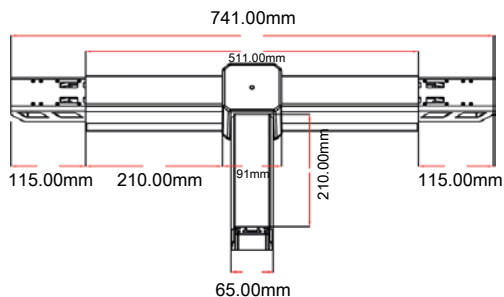

ΤΥΠΟΣ "T" 3 ΑΡΣΕΝΙΚΑ

TYPE "T" 3 MALE



511x301x100mm

Volt: **220-240V 50/60Hz**

Υλικό / Material:

Αλουμίνιο, Πλαστικό & Χαλκός / Aluminium, Plastic & Cooper

Σύνδεση / Connection:

Κλέμμα / Terminal block



CODE	BARCODE	COLOR	PACKING	MOQ	PRICE (€)
145-58210	5207227302886	WHITE	1/8	1	141,45

ΤΥΠΟΣ "T" 2 ΘΗΛΥΚΑ ΣΕ 1 ΑΡΣΕΝΙΚΟ ΑΡΙΣΤΕΡΟ

TYPE "T" 2 FEMALE TO 1 MALE LEFT



511x301x100mm

Volt: **220-240V 50/60Hz**

Υλικό / Material:

Αλουμίνιο, Πλαστικό & Χαλκός / Aluminium, Plastic & Cooper

Σύνδεση / Connection:

Κλέμμα / Terminal block



CODE	BARCODE	COLOR	PACKING	MOQ	PRICE (€)
145-58211	5207227302886	WHITE	1/8	1	141,45

ΤΥΠΟΣ "T" 2 ΘΗΛΥΚΑ ΣΕ 1 ΑΡΣΕΝΙΚΟ ΜΕΣΑΙΟ

TYPE "T" 2 FEMALE TO 1 MALE MIDDLE



511x301x100mm

Volt: **220-240V 50/60Hz**

Υλικό / Material:

Αλουμίνιο, Πλαστικό & Χαλκός / Aluminium, Plastic & Cooper

Σύνδεση / Connection:

Κλέμμα / Terminal block



CODE	BARCODE	COLOR	PACKING	MOQ	PRICE (€)
145-58212	5207227302930	WHITE	1/8	1	141,45

ΤΥΠΟΣ "T" 2 ΘΗΛΥΚΑ ΣΕ 1 ΑΡΣΕΝΙΚΟ ΔΕΞΙΑ

TYPE "T" 2 FEMALE TO 1 MALE RIGHT



511x301x100mm

Volt: **220-240V 50/60Hz**

Υλικό / Material:

Αλουμίνιο, Πλαστικό & Χαλκός / Aluminium, Plastic & Cooper

Σύνδεση / Connection:

Κλέμμα / Terminal block



CODE	BARCODE	COLOR	PACKING	MOQ	PRICE (€)
145-58213	5207227302961	WHITE	1/8	1	141,45

ΤΥΠΟΣ "Τ" 1 ΘΗΛΥΚΟ ΣΕ 2 ΑΡΣΕΝΙΚΑ ΑΡΙΣΤΕΡΟ

TYPE "T" 1 FEMALE TO 2 MALE LEFT



51x301x100mm

Volt: **220-240V 50/60Hz**

Υλικό / Material:

Αλουμίνιο, Πλαστικό & Χαλκός /

Aluminium, Plastic & Cooper

Σύνδεση / Connection:

Κλέμμα / Terminal block



CLASS I



2,05kg



220-240V



-25 | +45 °C



5 YEARS WARRANTY

CODE	BARCODE	COLOR	PACKING	MOQ	PRICE (€)
145-58214	5207227302954	WHITE	1/8	1	141,45

ΤΥΠΟΣ "Τ" 1 ΘΗΛΥΚΟ ΣΕ 2 ΑΡΣΕΝΙΚΑ ΜΕΣΑΙΟ

TYPE "T" 1 FEMALE TO 2 MALE MIDDLE



51x301x100mm

Volt: **220-240V 50/60Hz**

Υλικό / Material:

Αλουμίνιο, Πλαστικό & Χαλκός /

Aluminium, Plastic & Cooper

Σύνδεση / Connection:

Κλέμμα / Terminal block



CLASS I



2,05kg



220-240V



-25 | +45 °C



5 YEARS WARRANTY

CODE	BARCODE	COLOR	PACKING	MOQ	PRICE (€)
145-58215	5207227302947	WHITE	1/8	1	141,45

ΤΥΠΟΣ "Τ" 1 ΘΗΛΥΚΟ ΣΕ 2 ΑΡΣΕΝΙΚΑ ΔΕΞΙΑ

TYPE "T" 1 FEMALE TO 2 MALE RIGHT



51x301x100mm

Volt: **220-240V 50/60Hz**

Υλικό / Material:

Αλουμίνιο, Πλαστικό & Χαλκός /

Aluminium, Plastic & Cooper

Σύνδεση / Connection:

Κλέμμα / Terminal block



CLASS I



2,05kg



220-240V



-25 | +45 °C



5 YEARS WARRANTY

CODE	BARCODE	COLOR	PACKING	MOQ	PRICE (€)
145-58216	5207227302923	WHITE	1/8	1	141,45

ΤΥΠΟΣ "Τ" 3 ΘΗΛΥΚΑ

TYPE "T" 3 FEMALE



51x301x100mm

Volt: **220-240V 50/60Hz**

Υλικό / Material:

Αλουμίνιο, Πλαστικό & Χαλκός /

Aluminium, Plastic & Cooper

Σύνδεση / Connection:

Κλέμμα / Terminal block



CLASS I



2,05kg



220-240V



-25 | +45 °C



5 YEARS WARRANTY

CODE	BARCODE	COLOR	PACKING	MOQ	PRICE (€)
145-58217	5207227302909	WHITE	1/8	1	141,45



Επάνω όψη / View from above

Κάτω όψη / View from Below

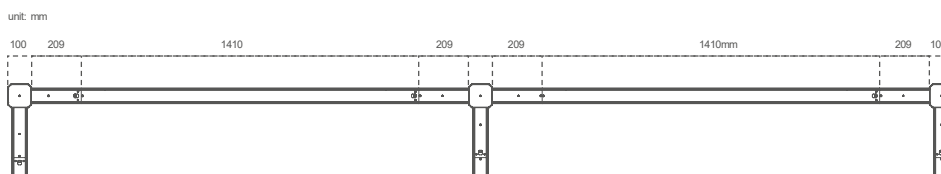

ΣΥΝΔΕΣΜΟΣ ΣΤΑΥΡΟΣ ΤΥΠΟΣ "X" S-LINE FLEX CONNECTOR CROSS TYPE "X" S-LINE FLEX

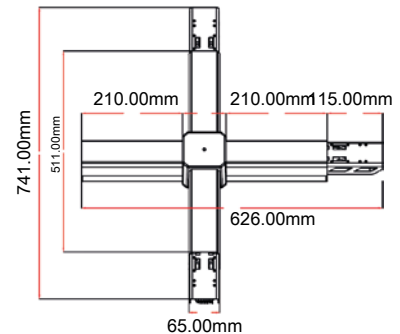

ΤΥΠΟΣ "X" 4 ΑΡΣΕΝΙΚΑ

TYPE "X" 4 MALE



511x511x100mm
Volt: **220-240V 50/60Hz**
Υλικό / Material:
**Αλουμίνιο, Πλαστικό & Χαλκός /
Aluminium, Plastic & Cooper**
Σύνδεση / Connection:
Κλέμμα / Terminal block



CODE	BARCODE	COLOR	PACKING	MOQ	PRICE (€)
145-58218	5207227302978	WHITE	1/2	1	181,25

ΤΥΠΟΣ "X" 1 ΘΗΛΥΚΟ - 3 ΑΡΣΕΝΙΚΑ

TYPE "X" 1 FEMALE - 3 MALE



511x511x100mm
Volt: **220-240V 50/60Hz**
Υλικό / Material:
**Αλουμίνιο, Πλαστικό & Χαλκός /
Aluminium, Plastic & Cooper**
Σύνδεση / Connection:
Κλέμμα / Terminal block



CODE	BARCODE	COLOR	PACKING	MOQ	PRICE (€)
145-58219	5207227302916	WHITE	1/2	1	181,25

ΤΥΠΟΣ "X" 2 ΘΗΛΥΚΑ - 2 ΑΡΣΕΝΙΚΑ

TYPE "X" 2 FEMALE - 2 MALE



511x511x100mm
Volt: **220-240V 50/60Hz**
Υλικό / Material:
**Αλουμίνιο, Πλαστικό & Χαλκός /
Aluminium, Plastic & Cooper**
Σύνδεση / Connection:
Κλέμμα / Terminal block



CODE	BARCODE	COLOR	PACKING	MOQ	PRICE (€)
145-58220	5207227303005	WHITE	1/2	1	181,25

ΤΥΠΟΣ "X" 2 ΘΗΛΥΚΑ - 2 ΑΡΣΕΝΙΚΑ ΜΕΣΑΙΟ

TYPE "X" 2 FEMALE - 2 MALE MIDDLE



511x511x100mm
Volt: **220-240V 50/60Hz**
Υλικό / Material:
**Αλουμίνιο, Πλαστικό & Χαλκός /
Aluminium, Plastic & Cooper**
Σύνδεση / Connection:
Κλέμμα / Terminal block



CODE	BARCODE	COLOR	PACKING	MOQ	PRICE (€)
145-58221	5207227302985	WHITE	1/2	1	181,25

ΤΥΠΟΣ "X" 3 ΘΗΛΥΚΑ - 1 ΑΡΣΕΝΙΚΟ

TYPE "X" 3 FEMALE - 1 MALE

NEW

51x51x100mm

Volt: **220-240V 50/60Hz**

Υλικό / Material:

Αλουμίνιο, Πλαστικό & Χαλκός /

Aluminium, Plastic & Cooper

Σύνδεση / Connection:

Κλέμμα / Terminal block



CODE	BARCODE	COLOR	PACKING	MOQ	PRICE (€)
145-58222	5207227303012	WHITE	1/2	1	181,25

ΤΥΠΟΣ "X" 4 ΘΗΛΥΚΑ

TYPE "X" 4 FEMALE

NEW

51x51x100mm

Volt: **220-240V 50/60Hz**

Υλικό / Material:

Αλουμίνιο, Πλαστικό & Χαλκός /

Aluminium, Plastic & Cooper

Σύνδεση / Connection:

Κλέμμα / Terminal block



CODE	BARCODE	COLOR	PACKING	MOQ	PRICE (€)
145-58223	5207227303036	WHITE	1/2	1	181,25

ΓΡΑΜΜΙΚΟ ΣΥΣΤΗΜΑ LED LED LINEAR TRUNKING SYSTEM

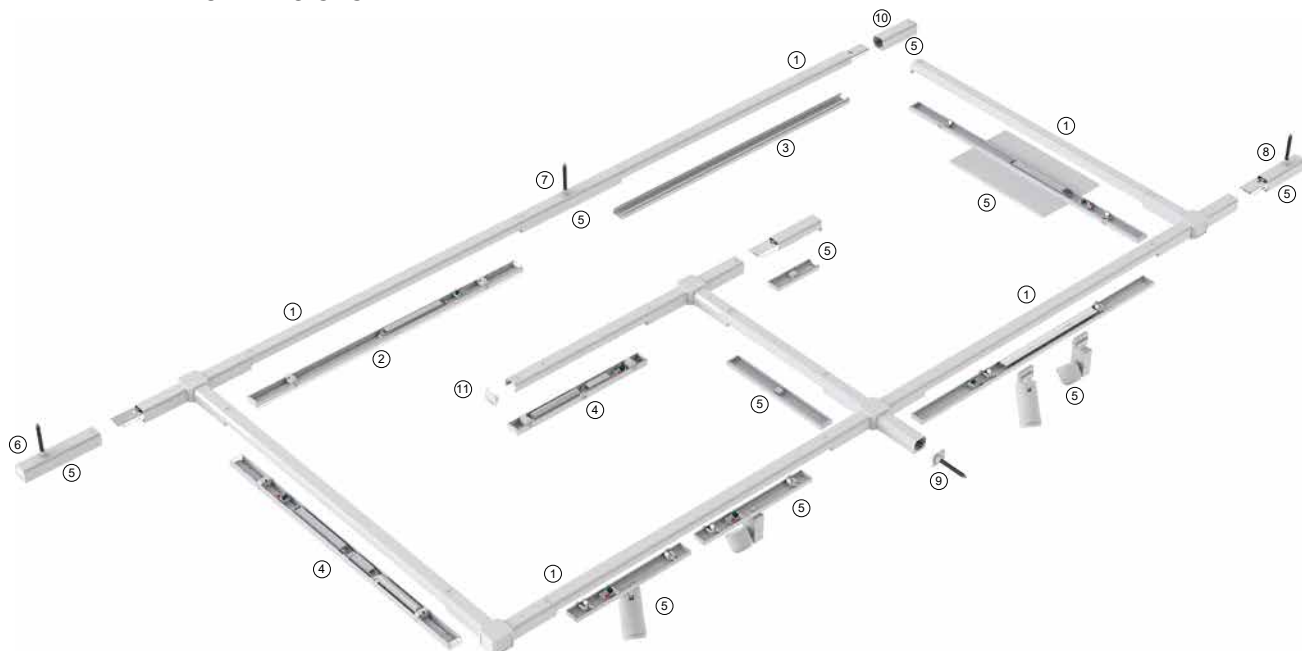

1. Βάση για Γραμμικό Φωτιστικό 8 καλώδια / Trunking Rail
2. LED Module DALI για Γραμμικό Φωτιστικό / Luminaire Module DALI
3. Κάλυμμα για Βάση Γραμμικού Φωτιστικού / Blank Cover
4. Module DALI LED με Εφεδρικό Φωτισμό / Emergency Module DALI LED
5. Σποτ Module, Σποτ Πάnel Module DALI για Γραμμικό Φωτιστικό / Track Light Module DALI
6. Τροφοδοσία Θηλυκή / Stfeed Feed-in from quick-connector

7. Τροφοδοσία ενδιάμεση / Midfeed Feed-in from middle position
8. Τροφοδοσία Αρσενική / Endfeed Feed-in from end
9. Τερματική Τάπα για Βάση Γραμμικού Φωτιστικού / Capfeed Feed-in from endcap
10. Κάλυμμα Θηλυκό / Stbox Cover quick-connector on the final rail
11. Τερματική Τάπα για Βάση Γραμμικού / Endcap

Προβολείς LED
εξωτερικού χώρου
οικιακής χρήσης

Flood Lights LED
for outdoor domestic use



ΠΡΟΒΟΛΕΑΣ LED SMD ΒΑΣΗ 360° PROJECTOR LED SMD BASE 360°

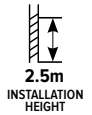
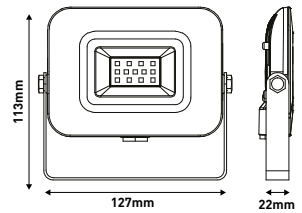

127x113x22mm

Volt: **220-240V 50/60Hz** • LED Type: **SMD2835**

Ένταση ρεύματος / Amperage: **50mA**

Γωνία Δέσμης Φωτός / Beam Angle: **100°**

Ενεργειακή Κλάση / Energy Class: **F**

Start Time: **0,5sec** • PF > **0,90** • CRI > **80** • IK06

Καλώδιο / Wire: **300mm 3x1mm²**

Υλικό / Material: **Αλουμίνιο & Γυαλί / Aluminium & Glass**



CODE	BARCODE	WATT	KELVIN	LUMEN/WATT	COLOR	PACKING	MOQ	PRICE (€)
147-69310	5207227061752	10	6500	110	WHITE	1/60	1	5,95
147-69311	5207227083112	10	4000	110	WHITE	1/60	1	5,95
147-69312	5207227061790	10	3000	110	WHITE	1/60	1	5,95
147-69313	5207227061813	10	6500	110	BLACK	1/60	1	5,95
147-69314	5207227061837	10	4000	110	BLACK	1/60	1	5,95
147-69315	5207227061851	10	3000	110	BLACK	1/60	1	5,95

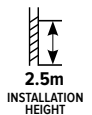
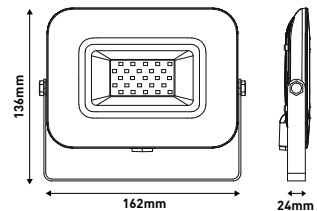

162x136x24mm

Volt: **220-240V 50/60Hz** • LED Type: **SMD2835**

Ένταση ρεύματος / Amperage: **100mA**

Γωνία Δέσμης Φωτός / Beam Angle: **100°**

Ενεργειακή Κλάση / Energy Class: **F**

Start Time: **0,5sec** • PF > **0,90** • CRI > **80** • IK06

Καλώδιο / Wire: **300mm 3x1mm²**

Υλικό / Material: **Αλουμίνιο & Γυαλί / Aluminium & Glass**



CODE	BARCODE	WATT	KELVIN	LUMEN/WATT	COLOR	PACKING	MOQ	PRICE (€)
147-69316	5207227061875	20	6500	110	WHITE	1/40	1	10,35
147-69317	5207227061899	20	4000	110	WHITE	1/40	1	10,35
147-69318	5207227061912	20	3000	110	WHITE	1/40	1	10,35
147-69319	5207227061936	20	6500	110	BLACK	1/40	1	10,35
147-69320	5207227061950	20	4000	110	BLACK	1/40	1	10,35
147-69321	5207227061974	20	3000	110	BLACK	1/40	1	10,35

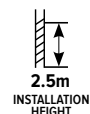
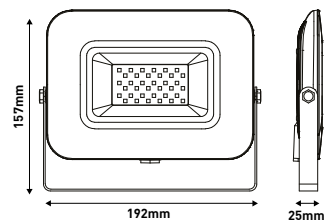

192x157x25mm

Volt: **220-240V 50/60Hz** • LED Type: **SMD2835**

Ένταση ρεύματος / Amperage: **150mA**

Γωνία Δέσμης Φωτός / Beam Angle: **100°**

Ενεργειακή Κλάση / Energy Class: **F**

Start Time: **0,5sec** • PF > **0,90** • CRI > **80** • IK06

Καλώδιο / Wire: **300mm 3x1mm²**

Υλικό / Material: **Αλουμίνιο & Γυαλί / Aluminium & Glass**



GROUNDING



-40 | +50 °C



CLASS I



0,480kg



30.000h



ON OFF
25.000



IP65



2 YEARS WARRANTY

CODE	BARCODE	WATT	KELVIN	LUMEN/WATT	COLOR	PACKING	MOQ	PRICE (€)
147-69322	5207227061998	30	6500	110	WHITE	1/20	1	15,35
147-69323	5207227062018	30	4000	110	WHITE	1/20	1	15,35
147-69324	5207227062032	30	3000	110	WHITE	1/20	1	15,35
147-69325	5207227062056	30	6500	110	BLACK	1/20	1	15,35
147-69326	5207227062070	30	4000	110	BLACK	1/20	1	15,35
147-69327	5207227062094	30	3000	110	BLACK	1/20	1	15,35

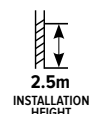
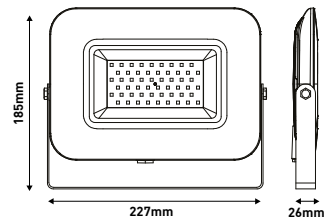

227x185x26mm

Volt: **220-240V 50/60Hz** • LED Type: **SMD2835**

Ένταση ρεύματος / Amperage: **250mA**

Γωνία Δέσμης Φωτός / Beam Angle: **100°**

Ενεργειακή Κλάση / Energy Class: **E**

Start Time: **0,5sec** • PF > **0,90** • CRI > **80** • IK06

Καλώδιο / Wire: **300mm 3x1mm²**

Υλικό / Material: **Αλουμίνιο & Γυαλί / Aluminium & Glass**



GROUNDING



-40 | +50 °C



CLASS I



0,670kg



30.000h



ON OFF
25.000



IP65



2 YEARS WARRANTY

CODE	BARCODE	WATT	KELVIN	LUMEN/WATT	COLOR	PACKING	MOQ	PRICE (€)
147-69328	5207227062117	50	6500	110	WHITE	1/20	1	21,45
147-69329	5207227062131	50	4000	110	WHITE	1/20	1	21,45
147-69330	5207227062155	50	3000	110	WHITE	1/20	1	21,45
147-69331	5207227062179	50	6500	110	BLACK	1/20	1	21,45
147-69332	5207227062193	50	4000	110	BLACK	1/20	1	21,45
147-69333	5207227062216	50	3000	110	BLACK	1/20	1	21,45

ΠΡΟΒΟΛΕΑΣ LED SMD ΒΑΣΗ 360° PROJECTOR LED SMD BASE 360°

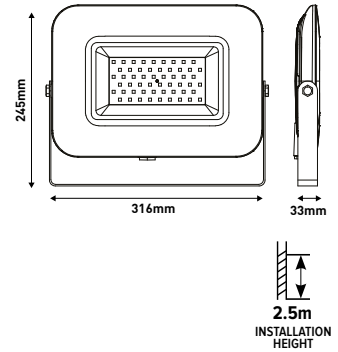

316x245x33mm

Volt: **220-240V 50/60Hz** • LED Type: **SMD2835**

Ένταση ρεύματος / Amperage: **350mA**

Γωνία Δέσμης Φωτός / Beam Angle: **100°**

Ενεργειακή Κλάση / Energy Class: **F**

Start Time: **0,5sec** • PF > **0,90** • CRI > **80** • IK06

Καλώδιο / Wire: **300mm 3x1mm²**

Υλικό / Material: **Αλουμίνιο & Γυαλί / Aluminium & Glass**

GROUNDING
 -40 | +50 °C
 CLASS I
 1,800kg
 30.000h
 ON OFF 25.000
 IP65
 2 YEARS WARRANTY

CODE	BARCODE	WATT	KELVIN	LUMEN/WATT	COLOR	PACKING	MOQ	PRICE (€)
147-69337	5207227122842	70	6500	110	BLACK	1/20	1	36,55
147-69338	5207227120640	70	4000	110	BLACK	1/20	1	36,55
147-69339	5207227122866	70	3000	110	BLACK	1/20	1	36,55

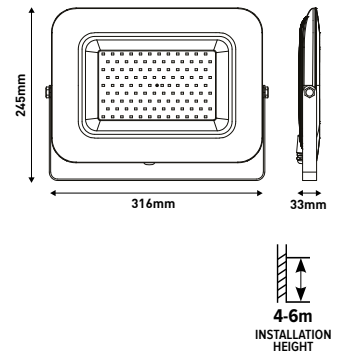

316x245x33mm

Volt: **220-240V 50/60Hz** • LED Type: **SMD2835**

Ένταση ρεύματος / Amperage: **500mA**

Γωνία Δέσμης Φωτός / Beam Angle: **100°**

Ενεργειακή Κλάση / Energy Class: **E**

Start Time: **0,5sec** • PF > **0,90** • CRI > **80** • IK07

Καλώδιο / Wire: **300mm 3x1mm²**

Υλικό / Material: **Αλουμίνιο & Γυαλί / Aluminium & Glass**

GROUNDING
 -40 | +50 °C
 CLASS I
 1,800kg
 50.000h
 ON OFF 25.000
 IP65
 2 YEARS WARRANTY

CODE	BARCODE	WATT	KELVIN	LUMEN/WATT	COLOR	PACKING	MOQ	PRICE (€)
147-69350	5207227062230	100	6500	110	BLACK	1/10	1	42,85
147-69351	5207227062254	100	4000	110	BLACK	1/10	1	42,85
147-69352	5207227062278	100	3000	110	BLACK	1/10	1	42,85

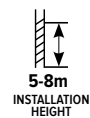
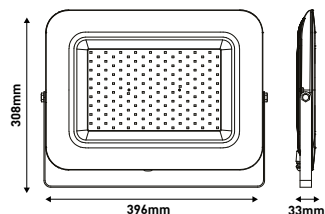

396x308x33mm

Volt: **220-240V 50/60Hz** • LED Type: **SMD2835**

Ένταση ρεύματος / Amperage: **750mA**

Γωνία Δέσμης Φωτός / Beam Angle: **100°**

Ενεργειακή Κλάση / Energy Class: **G**

Start Time: **0,5sec** • PF > **0,90** • CRI > **80** • IK07

Καλώδιο / Wire: **300mm 3x1mm²**

Υλικό / Material: **Αλουμίνιο & Γυαλί / Aluminium & Glass**



GROUNDING



-40 | +50 °C



CLASS I



3,400kg



30.000h



ON
OFF

25.000



IP65



2
YEARS
WARRANTY

CODE	BARCODE	WATT	KELVIN	LUMEN/WATT	COLOR	PACKING	MOQ	PRICE (€)
147-69353	5207227062292	150	6500	110	BLACK	1/4	1	67,95
147-69354	5207227062315	150	4000	110	BLACK	1/4	1	67,95
147-69355	5207227062339	150	3000	110	BLACK	1/4	1	67,95



ΠΡΟΒΟΛΕΑΣ LED SMD SLIM ΒΑΣΗ 360° PROJECTOR LED SMD SLIM BASE 360°

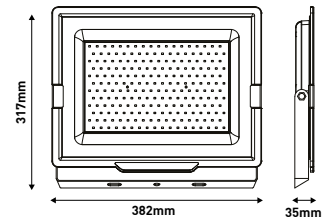

382x317x35mm

Volt: **220-240V 50/60Hz** • LED Type: **SMD2835**

Ένταση ρεύματος / Amperage: **1000mA**

Γωνία Δέσμης Φωτός / Beam Angle: **100°**

Ενεργειακή Κλάση / Energy Class: **G**

Start Time: **0,5sec** • PF > **0,90** • CRI > **80** • IK07

Καλώδιο / Wire: **300mm 3x1mm²**

Υλικό / Material: **Αλουμίνιο & Γυαλί / Aluminium & Glass**



GROUNDING



-40 | +50 °C



CLASS I



2,400kg



50.000h



ON OFF
25.000



IP65



2 YEARS WARRANTY

CODE	BARCODE	WATT	KELVIN	LUMEN/WATT	COLOR	PACKING	MOQ	PRICE (€)
147-69356	5207227120664	200	6500	110	BLACK	1/5	1	72,65
147-69357	5207227120688	200	4000	110	BLACK	1/5	1	72,65

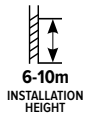
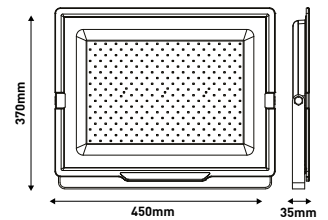

450x370x35mm

Volt: **220-240V 50/60Hz** • LED Type: **SMD2835**

Ένταση ρεύματος / Amperage: **1500mA**

Γωνία Δέσμης Φωτός / Beam Angle: **100°**

Ενεργειακή Κλάση / Energy Class: **G**

Start Time: **0,5sec** • PF > **0,90** • CRI > **80** • IK07

Καλώδιο / Wire: **300mm 3x1,5mm²**

Υλικό / Material: **Αλουμίνιο & Γυαλί / Aluminium & Glass**



GROUNDING



-40 | +50 °C



CLASS I



3,100kg



50.000h



ON OFF
25.000



IP65



2 YEARS WARRANTY

CODE	BARCODE	WATT	KELVIN	LUMEN/WATT	COLOR	PACKING	MOQ	PRICE (€)
147-69358	5207227120701	300	6500	110	BLACK	1/4	1	128,45
147-69359	5207227120725	300	4000	110	BLACK	1/4	1	128,45

ΠΡΟΒΟΛΕΑΣ LED SMD ΒΑΣΗ 360° PROJECTOR LED SMD BASE 360°

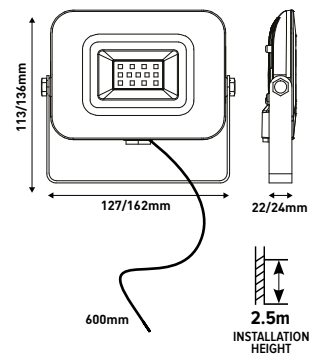

Καλώδιο / Wire
600mm

127x113x22mm / 162x136x24mm*

Volt: **220-240V 50/60Hz** • LED Type: **SMD2835**

Γωνία Δέσμης Φωτός / Beam Angle: **100°**

Ενεργειακή Κλάση / Energy Class: **E**

Start Time: **0,5sec** • **IK06**

Καλώδιο / Wire: **600mm 3x1mm²**

Υλικό / Material: **Αλουμίνιο & Γυαλί / Aluminium & Glass**



Lm/W
95



ON OFF
25,000



2
YEARS WARRANTY

CODE	BARCODE	WATT	KELVIN	AMPERAGE	PF	CRI	WEIGHT	COLOR	PACKING	MOQ	PRICE (€)
147-69701	5207227077203	10	4000	50mA	>80	>70	0,230kg	GRAPHITE	1/60	1	7,75
147-69702	5207227077234	10	3000	50mA	>80	>70	0,230kg	GRAPHITE	1/60	1	7,75
147-69704 *	5207227077258	20	4000	100mA	>90	>80	0,350kg	GRAPHITE	1/40	1	12,15
147-69705 *	5207227077272	20	3000	100mA	>90	>80	0,350kg	GRAPHITE	1/40	1	12,15

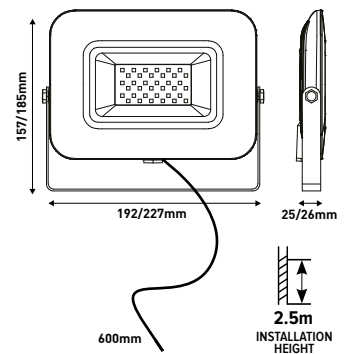

Καλώδιο / Wire
600mm

192x157x25mm / 227x185x26mm*

Volt: **220-240V 50/60Hz** • LED Type: **SMD2835**

Γωνία Δέσμης Φωτός / Beam Angle: **100°**

Ενεργειακή Κλάση / Energy Class: **E**

Start Time: **0,5sec** • **IK06**

Καλώδιο / Wire: **600mm 3x1mm²**

Υλικό / Material: **Αλουμίνιο & Γυαλί / Aluminium & Glass**



Lm/W
95



ON OFF
25,000



2
YEARS WARRANTY

CODE	BARCODE	WATT	KELVIN	AMPERAGE	PF	CRI	WEIGHT	COLOR	PACKING	MOQ	PRICE (€)
147-69707	5207227077296	30	4000	150mA	>90	>70	0,480kg	GRAPHITE	1/20	1	15,85
147-69708	5207227077326	30	3000	150mA	>90	>70	0,480kg	GRAPHITE	1/20	1	15,85
147-69710 *	5207227077357	50	4000	250mA	>90	>80	0,670kg	GRAPHITE	1/20	1	22,55
147-69711 *	5207227077371	50	3000	250mA	>90	>80	0,670kg	GRAPHITE	1/20	1	22,55

ΠΡΟΒΟΛΕΑΣ LED SMD ΜΕ ΠΕΡΙΣΤΡΕΦΟΜΕΝΟ ΑΝΙΧΝΕΥΤΗ ΚΙΝΗΣΗΣ PROJECTOR LED SMD WITH ROTATED MOVEMENT DETECTOR



160x115x50mm

Volt: **220-240V 50/60Hz** • LED Type: **SMD2835**
 Τύπος Ανιχνευτή / Detector Type: **PIR**
 Ενταση ρεύματος / Amperage: **50mA**
 Γωνία Δέσμης Φωτός / Beam Angle: **100°**
 Ενεργειακή Κλάση / Energy Class: **F**
 Start Time: **0,5sec** • PF > **0,90** • CRI > **80** • IK06
 Καλώδιο / Wire: **300mm 3x1mm²**
 Χρόνος Λειτουργίας Αισθητήρα /
 Sensor Working Time: **10sec - 8min**
 Απόσταση Ανίχνευσης / Detection Distance: **10m**
 Υλικό / Material: **Αλουμίνιο & PC / Aluminium & PC**

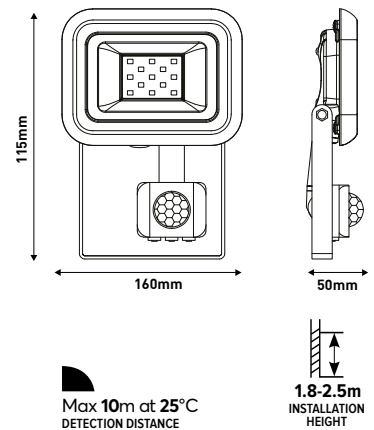

CODE	BARCODE	WATT	KELVIN	LUMEN/WATT	COLOR	PACKING	MOQ	PRICE (€)
147-69650	5207227109652	10	6500	105	WHITE	1/40	1	16,25
147-69651	5207227109676	10	4000	105	WHITE	1/40	1	16,25
147-69630	5207227058325	10	6500	105	BLACK	1/40	1	16,25
147-69631	5207227058349	10	4000	105	BLACK	1/40	1	16,25



180x137x50mm

Volt: **220-240V 50/60Hz** • LED Type: **SMD2835**
 Τύπος Ανιχνευτή / Detector Type: **PIR**
 Ενταση ρεύματος / Amperage: **100mA**
 Γωνία Δέσμης Φωτός / Beam Angle: **100°**
 Ενεργειακή Κλάση / Energy Class: **F**
 Start Time: **0,5sec** • PF > **0,90** • CRI > **80** • IK06
 Καλώδιο / Wire: **300mm 3x1mm²**
 Χρόνος Λειτουργίας Αισθητήρα /
 Sensor Working Time: **10sec - 8min**
 Απόσταση Ανίχνευσης / Detection Distance: **10m**
 Υλικό / Material: **Αλουμίνιο & PC / Aluminium & PC**

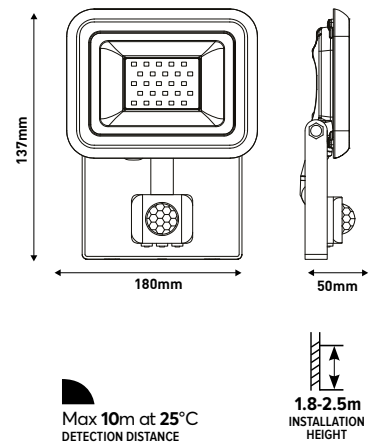

CODE	BARCODE	WATT	KELVIN	LUMEN/WATT	COLOR	PACKING	MOQ	PRICE (€)
147-69653	5207227109690	20	6500	105	WHITE	1/20	1	19,45
147-69654	5207227109713	20	4000	105	WHITE	1/20	1	19,45
147-69633	5207227058387	20	6500	105	BLACK	1/20	1	19,45
147-69634	5207227058400	20	4000	105	BLACK	1/20	1	19,45

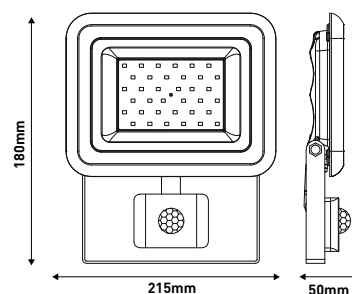

Max 10m at 25°C
DETECTION DISTANCE

3-5m
INSTALLATION
HEIGHT

215x180x50mm

Volt: **220-240V 50/60Hz** • LED Type: **SMD2835**
Ένταση ρεύματος / Amperage: **150mA**
Γωνία Δέσμης Φωτός / Beam Angle: **100°**
Ενεργειακή Κλάση / Energy Class: **F**
Start Time: **0,5sec** • PF > **0,90** • CRI > **80** • IK06
Καλώδιο / Wire: **300mm 3x1mm²**
Χρόνος Λειτουργίας Αισθητήρα /
Sensor Working Time: **10sec - 8min**
Απόσταση Ανίχνευσης / Detection Distance: **10m**
Υλικό / Material: **Αλουμίνιο & PC / Aluminium & PC**



CODE	BARCODE	WATT	KELVIN	LUMEN/WATT	COLOR	PACKING	MOQ	PRICE (€)
147-69656	5207227109737	30	6500	105	WHITE	1/20	1	23,85
147-69636	5207227058448	30	6500	105	BLACK	1/20	1	23,85
147-69637	5207227058462	30	4000	105	BLACK	1/20	1	23,85
147-69638	5207227058486	30	3000	95	BLACK	1/20	1	23,85

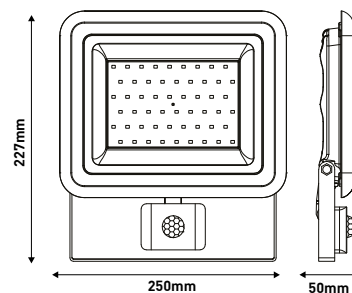

Max 10m at 25°C
DETECTION DISTANCE

3-5m
INSTALLATION
HEIGHT

250x227x50mm

Volt: **220-240V 50/60Hz** • LED Type: **SMD2835**
Ένταση ρεύματος / Amperage: **250mA**
Γωνία Δέσμης Φωτός / Beam Angle: **100°**
Ενεργειακή Κλάση / Energy Class: **F**
Start Time: **0,5sec** • PF > **0,90** • CRI > **80** • IK06
Καλώδιο / Wire: **300mm 3x1mm²**
Χρόνος Λειτουργίας Αισθητήρα /
Sensor Working Time: **10sec - 8min**
Απόσταση Ανίχνευσης / Detection Distance: **10m**
Υλικό / Material: **Αλουμίνιο & PC / Aluminium & PC**



CODE	BARCODE	WATT	KELVIN	LUMEN/WATT	COLOR	PACKING	MOQ	PRICE (€)
147-69659	5207227109775	50	6500	105	WHITE	1/10	1	29,45
147-69660	5207227109799	50	4000	105	WHITE	1/10	1	29,45
147-69642	5207227058509	50	6500	105	BLACK	1/10	1	29,45
147-69643	5207227058523	50	4000	105	BLACK	1/10	1	29,45

ΠΡΟΒΟΛΕΑΣ LED SMD ΜΕ ΑΝΙΧΝΕΥΤΗ ΗΜΕΡΑΣ / ΝΥΧΤΑΣ PROJECTOR LED SMD WITH DAY / NIGHT DETECTOR



- Ανάβει αυτόματα όταν το φως του περιβάλλοντα χώρου είναι κάτω από 30 LUX / Turns on automatically when the light of the surrounding area is below 30 LUX
- Σβήνει αυτόματα όταν το φως του περιβάλλοντα χώρου είναι πάνω από 50 LUX / Turns off automatically when the light of the surrounding area is over 50 LUX

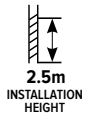
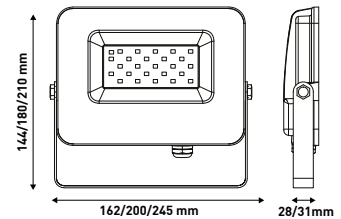

Volt: **220-240V 50/60Hz** • LED Type: **SMD2835**

Γωνία Δέσμης Φωτός / Beam Angle: **100°**

Ενεργειακή Κλάση / Energy Class: **F**

Start Time: **0,5sec** • PF > **0,90** • CRI > **80** • IK06

Καλώδιο / Wire: **300mm 3x1mm²**

Υλικό / Material:

Αλουμίνιο & Γυαλί / Aluminium & Glass



Lm/W
85

-40 | +50 °C



30.000h

ON OFF
25.000



2 YEARS WARRANTY

CODE	BARCODE	WATT	AMPERAGE	KELVIN	DIMENSIONS	WEIGHT	COLOR	PACKING	MOQ	PRICE (€)
147-69360	5207227067518	20	100mA	6500	162x144x28mm	0.410kg	DARK GREY	1/30	1	16,55
147-69361	5207227067532	20	100mA	4200	162x144x28mm	0.410kg	DARK GREY	1/30	1	16,55
147-69362	5207227067556	30	150mA	6500	200x180x28mm	0.620kg	DARK GREY	1/20	1	21,45
147-69363	5207227067570	30	150mA	4200	200x180x28mm	0.620kg	DARK GREY	1/20	1	21,45
147-69364	5207227067594	50	250mA	6500	245x210x31mm	0.920kg	DARK GREY	1/10	1	29,65
147-69365	5207227067662	50	250mA	4200	245x210x31mm	0.920kg	DARK GREY	1/10	1	29,65

ΠΡΟΒΟΛΕΑΣ LED SMD 10-30W PROJECTOR LED SMD 10-30W

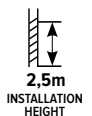
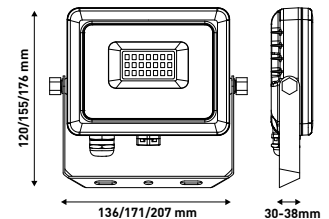

12V/24V

Volt: **12V/24V DC** • LED Type: **SMD2835**

Γωνία Δέσμης Φωτός / Beam Angle: **100°**

Ενεργειακή Κλάση / Energy Class: **F**

Start Time: **0,5sec** • PF > **0,90** • CRI > **80** • IK06

Καλώδιο / Wire: **300mm 3x1mm²**

Υλικό / Material: **Αλουμίνιο & Γυαλί / Aluminium & Glass**

Lm/W
85

-40 | +50 °C



36.000h

ON OFF
25.000



2 YEARS WARRANTY

CODE	BARCODE	WATT	AMPERAGE	KELVIN	DIMENSIONS	WEIGHT	COLOR	PACKING	MOQ	PRICE (€)
147-69380	5207227070174	10	1000mA	4000	136x120x30mm	0.587kg	BLACK	1/20	1	12,15
147-69381	5207227070198	20	2000mA	4000	171x155x37mm	0.587kg	BLACK	1/20	1	22,85
147-69382	5207227070211	30	3000mA	4000	207x176x38mm	0.875kg	BLACK	1/10	1	32,60
147-69383	5207227149474	10	1000mA	6500	136x120x30mm	0.587kg	BLACK	1/20	1	19,25
147-69384	5207227149481	20	2000mA	6500	171x155x37mm	0.587kg	BLACK	1/20	1	29,65
147-69385	5207227149498	30	3000mA	6500	207x176x38mm	0.875kg	BLACK	1/10	1	39,80

ΠΡΟΒΟΛΕΑΣ LED SMD 50-150W PROJECTOR LED SMD 50-150W

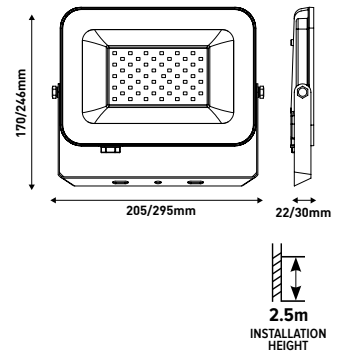

42V

Volt: **42V DC** • LED Type: **SMD2835**

Γωνία Δέσμης Φωτός / Beam Angle: **120°**

Ενεργειακή Κλάση / Energy Class: **F**

Start Time: **0,5sec** • CRI **70** • IK**06**

Καλώδιο / Wire (147-69386): **150mm 2x1mm²**

Καλώδιο / Wire (147-69387): **300mm 2x1mm²**

Υλικό / Material: **Αλουμίνιο & Γυαλί / Aluminium & Glass**

Lm/W
100

-20 | +40 °C

CLASS III

COLOR
BLACK

36.000h

ON OFF
18.000

IP65

2 YEARS WARRANTY

CODE	BARCODE	WATT	AMPERAGE	KELVIN	DIMENSIONS	WEIGHT	PACKING	MOQ	PRICE (€)
147-69386	5207227257407	50	1200mA	6500	205x170x22mm	0.5kg	1/20	1	28,85
147-69387	5207227257421	100	2400mA	6500	295x246x30mm	1.25kg	1/10	1	54,65

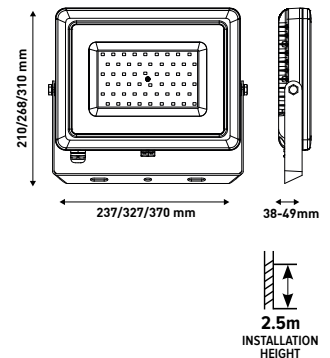

80-265V

Volt: **80-265V 50/60Hz** • LED Type: **SMD2835**

Γωνία Δέσμης Φωτός / Beam Angle: **120°**

Ενεργειακή Κλάση / Energy Class: **E**

Start Time: **0,5sec** • PF **≥ 0,90** • CRI **70** • IK**08**

Καλώδιο / Wire (147-69386): **300mm 3x1mm²**

Υλικό / Material:

Αλουμίνιο & Γυαλί / Aluminium & Glass

GROUNDING

Lm/W
130

-40 | +50 °C

CLASS I

COLOR
BLACK

36.000h

ON OFF
18.000

IP66

3 YEARS WARRANTY

CODE	BARCODE	WATT	AMPERAGE	KELVIN	DIMENSIONS	WEIGHT	PACKING	MOQ	PRICE (€)
147-69300	5207227257452	50	250mA	6500	237x210x38mm	1.30kg	1/10	1	37,25
147-69302	5207227257476	100	500mA	6500	327x268x48mm	2.56kg	1/5	1	69,85
147-69304	5207227257490	150	750mA	6500	370x310x49mm	3.66kg	1/4	1	108,80

ΠΡΟΒΟΛΕΑΣ LED SMD RGB PROJECTOR RECHARGEABLE LED SMD RGB

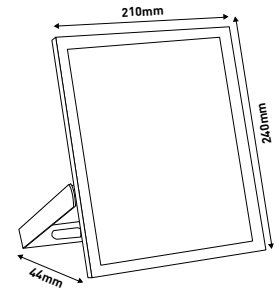

RGB

Volt: **100-265V 50/60Hz** • LED Type: **SMD2835**
 Γωνία Δέσμης Φωτός / Beam Angle: **120°**
 Ενεργειακή Κλάση / Energy Class: **G**
 Start Time: **0,5sec** • PF > **0,90** • CRI > **80** • IK07
 Καλώδιο / Wire: **300mm 2x0,75mm²**
 Υλικό / Material:

Αλουμίνιο & Γυαλί / Aluminium & Glass

Με τηλεχειριστήριο (περιλαμβάνει μπαταρίες) /
With remote control (batteries included)



Lm/W
80



COLOR
BLACK



ON OFF
15.000



CODE	BARCODE	WATT	AMPERAGE	KELVIN	DIMENSIONS	WEIGHT	PACKING	MOQ	PRICE (€)
147-69390	5207227068782	50	560mA	RGB	240x210x44mm	1.253kg	1/10	1	33,55

ΠΡΟΒΟΛΕΑΣ LED SMD ΠΡΑΣΙΝΟΣ & ΜΠΛΕ PROJECTOR LED SMD GREEN & BLUE

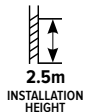
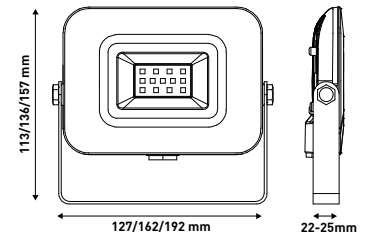

Green Blue

Volt: **220-240V 50/60Hz** • LED Type: **SMD2835**
 Γωνία Δέσμης Φωτός / Beam Angle: **100°**
 Start Time: **0,5sec** • CRI **70** • IK06
 Καλώδιο / Wire (147-69386): **300mm 3x1mm²**
 Υλικό / Material:

Αλουμίνιο & Γυαλί / Aluminium & Glass



Lm/W
70



COLOR
BLACK



ON OFF
25.000



CODE	BARCODE	WATT	Lm/W	AMPERAGE	PF	KELVIN	DIMENSIONS	WEIGHT	PACKING	MOQ	PRICE (€)
147-69270	5206139014351	10	70	50mA	>0.80	GREEN	127x113x22mm	0.230kg	1/60	1	7,65
147-69271	5206139014368	20	70	100mA	>0.80	GREEN	162x136x24mm	0.350kg	1/40	1	12,35
147-69273	5207227149504	30	60	150mA	>0.90	BLUE	192x157x25mm	0.480kg	1/20	1	16,45

ΠΡΟΒΟΛΕΑΣ LED COB ΕΠΑΝΑΦΟΡΤΙΖΟΜΕΝΟΣ PROJECTOR RECHARGEABLE LED COB



CAR ADAPTOR
 BATTERY TYPE: **18650 Lithium 3.7V**
 Charging cable: **8,4V 1A**
 Charging Time: **3h**
 Discharging Time: **4-5h**

Volt: **100-240V 50/60Hz** • LED Type: **COB30**
 Γωνία Δέσμης Φωτός / Beam Angle: **120°**
 Start Time: **3sec** • PF > **0.60** • CRI > **80** • IK08
 Καλώδιο / Wire: **2x0,75mm²**
 Υλικό / Material:
Πλαστικό, Αλουμίνιο & Σίδηρος /
Plastic, Aluminium & Iron

Lm/W 70 **-20 | +50 °C** **COLOR** YELLOW **25.000h** **ON OFF** 25.000 **IP65** **2 YEARS WARRANTY**

CODE	BARCODE	WATT	AMPERAGE	KELVIN	DIMENSIONS	WEIGHT	PACKING	MOQ	PRICE (€)
147-69240	5206139050212	10	260mA	4000	265x135x126mm	0.950kg	1/20	1	26,85
147-69241	5206139050236	20	260mA	4000	298x160x184mm	1.500kg	1/10	1	36,85

ΠΡΟΒΟΛΕΑΣ LED SMD ΦΟΡΗΤΟΣ PROJECTOR LED SMD MOVABLE

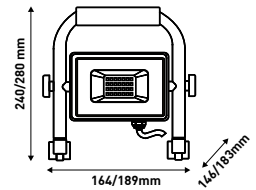

Volt: **220-240V 50/60Hz** • LED Type: **SMD2835**
 Γωνία Δέσμης Φωτός / Beam Angle: **120°**
 Ενεργειακή Κλάση / Energy Class: **G**
 Start Time: **0,5sec** • PF > **0,90** • CRI > **80** • IK07
 Καλώδιο / Wire: **1500mm 3x1mm²**
 Υλικό / Material:
Αλουμίνιο & Γυαλί / Aluminium & Glass

GROUNDING **Lm/W** 80 **-40 | +50 °C** **CLASS I** **COLOR** YELLOW **30.000h** **ON OFF** 15.000 **IP65** **2 YEARS WARRANTY**

CODE	BARCODE	WATT	AMPERAGE	KELVIN	DIMENSIONS	WEIGHT	PACKING	MOQ	PRICE (€)
147-69370	5207227068744	10	48mA	4000	146x164x240mm	0.770kg	1/20	1	16,85
147-69372	5207227068768	30	145mA	4000	189x183x280mm	1.169kg	1/10	1	27,45

ΒΑΣΕΙΣ ΠΡΟΒΟΛΕΑ PROJECTOR BASES



147-22422



147-22420
147-22421

Υλικό / Material:

Αλουμίνιο / Aluminium

CODE	BARCODE	WATT	DIMENSIONS	WEIGHT	COLOR	PACKING	MOQ	PRICE (€)
147-22420	5206139044914	20	265x205x75mm	0.500kg	YELLOW	1/20	1	7,75
147-22421	5206139044945	50	345x280x105mm	1.020kg	YELLOW	1/10	1	13,45
147-22422	5206139044891	10-50	960x1500mm	1.000kg	YELLOW	1/6	1	29,65



ΠΡΟΒΟΛΕΑΣ LED SMD ΗΛΙΑΚΟΣ PROJECTOR LED SMD SOLAR

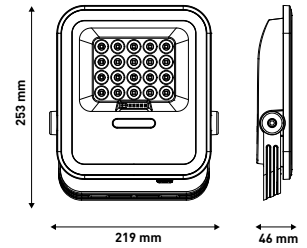

NEW

Volt: **3.2V DC** • LED Type: **SMD5050**
 Γωνία Δέσμης Φωτός / Beam Angle: **90° • 400lm**
 Start Time: **0,5sec** • CRI > **70** • IK07
 Καλώδιο / Wire: **2000mm 2x0,5mm²**
 Υλικό / Material: **ABS & Glass / Πλαστικό & Γυαλί**

Με τηλεχειριστήριο (περιλαμβάνει μπαταρίες) /
With remote control (baterries included)

Ηλιακό Πάνελ / Solar Panel: **5V 20W**
 Διαστάσεις / Dimensions: **210x200x17mm**
 Βάρος / Weight: **0,500kg**

Τύπος Μπαταρίας / Battery Type: **LiFePO4, 3.2V 5Ah**
 Charging Time: **5-8h**
 Discharging Time: **10-12h**



3-4m
 INSTALLATION
 HEIGHT

-25 | +45 °C **COLOR BLACK** **30.000h** **IP65** **2 YEARS WARRANTY**

CODE	BARCODE	WATT	KELVIN	DIMENSIONS	WEIGHT	PACKING	MOQ	PRICE (€)
147-69570	5207227288715	50	4000	219x253x46mm	1,800kg	1/10	1	41,50

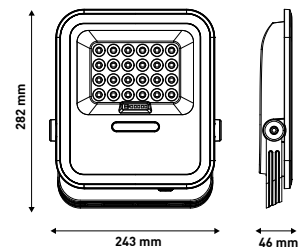

NEW

Volt: **3.2V DC** • LED Type: **SMD5050**
 Γωνία Δέσμης Φωτός / Beam Angle: **90° • 800lm**
 Start Time: **0,5sec** • CRI > **70** • IK07
 Καλώδιο / Wire: **2000mm 2x0,5mm²**
 Υλικό / Material: **ABS & Glass / Πλαστικό & Γυαλί**

Με τηλεχειριστήριο (περιλαμβάνει μπαταρίες) /
With remote control (baterries included)

Ηλιακό Πάνελ / Solar Panel: **5V 20W**
 Διαστάσεις / Dimensions: **300x205x17mm**
 Βάρος / Weight: **0,720kg**

Τύπος Μπαταρίας / Battery Type: **LiFePO4, 3.2V 10Ah**
 Charging Time: **5-8h**
 Discharging Time: **10-12h**



4-5m
 INSTALLATION
 HEIGHT

-25 | +45 °C **COLOR BLACK** **30.000h** **IP65** **2 YEARS WARRANTY**

CODE	BARCODE	WATT	KELVIN	DIMENSIONS	WEIGHT	PACKING	MOQ	PRICE (€)
147-69571	5207227288739	100	4000	243x282x46mm	2,300kg	1/5	1	57,95

ΠΡΟΒΟΛΕΑΣ LED SMD ΗΛΙΑΚΟΣ PROJECTOR LED SMD SOLAR



NEW

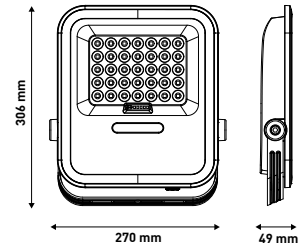

5-6m
INSTALLATION
HEIGHT

Volt: **3.2V DC** • LED Type: **SMD5050**
 Γωνία Δέσμης Φωτός / Beam Angle: **90° • 1800lm**
 Start Time: **0,5sec** • CRI > **70** • IK07
 Καλώδιο / Wire: **2000mm 2x1mm²**
 Υλικό / Material: **ABS & Glass / Πλαστικό & Γυαλί**

Με τηλεχειριστήριο (περιλαμβάνει μπαταρίες) /
With remote control (batteries included)

Ηλιακό Πάνελ / Solar Panel: **5V 20W**
 Διαστάσεις / Dimensions: **390x375x17mm**
 Βάρος / Weight: **1,0kg**

Τύπος Μπαταρίας / Battery Type: **LiFePO4, 3.2V 25Ah**
 Charging Time: **5-8h**
 Discharging Time: **10-12h**



-25 | +45 °C **COLOR BLACK** 30.000h **IP65** **2 YEARS WARRANTY**

CODE	BARCODE	WATT	KELVIN	DIMENSIONS	WEIGHT	PACKING	MOQ	PRICE (€)
147-69572	5207227301476	200	4000	270x306x49mm	2,900kg	1/5	1	109,80



NEW

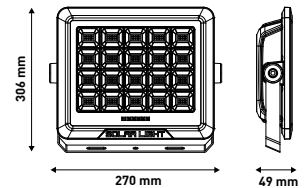

4-5m
INSTALLATION
HEIGHT

Volt: **3.2V DC** • LED Type: **SMD2835**
 Γωνία Δέσμης Φωτός / Beam Angle: **90° • 2200lm**
 Start Time: **0,5sec** • CRI > **70** • IK07
 Καλώδιο / Wire: **2000mm 2x0.75mm²**
 Υλικό / Material: **ABS & Glass / Πλαστικό & Γυαλί**

Με τηλεχειριστήριο (περιλαμβάνει μπαταρίες) /
With remote control (batteries included)

Ηλιακό Πάνελ / Solar Panel: **5V 20W**
 Διαστάσεις / Dimensions: **390x450x17mm**
 Βάρος / Weight: **1,400kg**

Τύπος Μπαταρίας / Battery Type: **LiFePO4, 3.2V 25Ah**
 Charging Time: **5-8h**
 Discharging Time: **10-12h**



-25 | +45 °C **COLOR BLACK** 30.000h **IP65** **2 YEARS WARRANTY**

CODE	BARCODE	WATT	KELVIN	DIMENSIONS	WEIGHT	PACKING	MOQ	PRICE (€)
147-69573	5207227301490	300	4000	300x356x73mm	4.100kg	1/4	1	146,30

ΠΡΟΒΟΛΕΑΣ LED SMD ΗΛΙΑΚΟΣ PROJECTOR LED SMD SOLAR

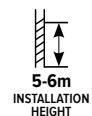
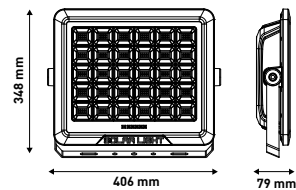

Volt: **3.2V DC** • LED Type: **SMD2835**
 Γωνία Δέσμης Φωτός / Beam Angle: **90° • 2800lm**
 Start Time: **0,5sec** • CRI > **70** • IK07
 Καλώδιο / Wire: **2000mm 2x1mm²**
 Υλικό / Material: **ABS & Glass / Πλαστικό & Γυαλί**



Με τηλεχειριστήριο (περιλαμβάνει μπαταρίες) /
With remote control (baterries included)

Ηλιακό Πάνελ / Solar Panel: **5V 20W**
 Διαστάσεις / Dimensions: **390x510x17mm**
 Βάρος / Weight: **1,800kg**

Τύπος Μπαταρίας / Battery Type: **LiFePO4, 3.2V 30Ah**
 Charging Time: **5-8h**
 Discharging Time: **10-12h**



Lm/W 7 **-25 | +45 °C** **COLOR BLACK** **30.000h** **IP65** **2 YEARS WARRANTY**

CODE	BARCODE	WATT	KELVIN	DIMENSIONS	WEIGHT	PACKING	MOQ	PRICE (€)
147-69574	5207227301476	400	4000	348x406x79mm	5,220kg	1/2	1	178,50

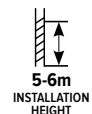
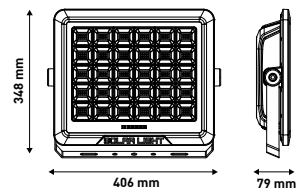

Volt: **3.2V DC** • LED Type: **SMD2835**
 Γωνία Δέσμης Φωτός / Beam Angle: **90° • 3600lm**
 Start Time: **0,5sec** • CRI > **70** • IK07
 Καλώδιο / Wire: **2000mm 2x1.5mm²**
 Υλικό / Material: **ABS & Glass / Πλαστικό & Γυαλί**



Με τηλεχειριστήριο (περιλαμβάνει μπαταρίες) /
With remote control (baterries included)

Ηλιακό Πάνελ / Solar Panel: **5V 20W**
 Διαστάσεις / Dimensions: **390x590x20mm**
 Βάρος / Weight: **2,200kg**

Τύπος Μπαταρίας / Battery Type: **LiFePO4, 3.2V 40Ah**
 Charging Time: **5-8h**
 Discharging Time: **10-12h**



-25 | +45 °C **COLOR BLACK** **30.000h** **IP65** **2 YEARS WARRANTY**

CODE	BARCODE	WATT	KELVIN	DIMENSIONS	WEIGHT	PACKING	MOQ	PRICE (€)
147-69575	5207227301490	500	4000	348x406x79mm	7,200kg	1/2	1	212,00

ΠΡΟΒΟΛΕΑΣ LED SMD ΗΛΙΑΚΟΣ ΜΕ ΚΑΜΕΡΑ PROJECTOR LED SMD SOLAR WITH CAMERA



Volt: **5V DC** • LED Type: **SMD2835**
 Γωνία Δέσμης Φωτός / Beam Angle: **90° • 7300lm**
 Start Time: **0,5sec** • CRI > **80** • IK07
 Καλώδιο / Wire: **5000mm 2x0,75mm²**
 Υλικό / Material: **Αλουμίνιο & Πλαστικό / Aluminium & Plastic**

Με τηλεχειριστήριο (περιλαμβάνει μπαταρίες) / **With remote control** (batteries included)

Ηλιακό Πάνελ / Solar Panel: **5V 20W**
 Διαστάσεις / Dimensions: **350x350x15mm**
 Βάρος / Weight: **0,800kg**

Κάμερα / Camera: **200million pixels**
1080P Day & Night / 32GB Card

Τύπος Μπαταρίας / Battery Type: **Lithium 12000mAh**
 Charging Time: **4-6h**
 Discharging Time: **12-18h**



-25 | +45 °C **COLOR BLACK** **30.000h** **ON OFF 15.000** **IP65** **2 YEARS WARRANTY**

CODE	BARCODE	WATT	KELVIN	DIMENSIONS	WEIGHT	PACKING	MOQ	PRICE (€)
147-69594	5207227116735	100	6500	179x217x45mm	2.500kg	1/8	1	149,80

ΠΡΟΒΟΛΕΑΣ LED SMD ΗΛΙΑΚΟΣ ΜΕ ΑΝΙΧΝΕΥΤΗ ΚΙΝΗΣΗΣ PROJECTOR LED SMD SOLAR WITH MOVEMENT DETECTOR



Volt: **5V DC** • LED Type: **SMD5630**
 Τύπος Ανιχνευτή / Detector Type: **PIR**
 Γωνία Δέσμης Φωτός / Beam Angle: **120° • 1650lm**
 Start Time: **0,5sec** • CRI > **80** • IK07
 Καλώδιο / Wire: **2000mm 2x0,75mm²**
 Sensor Working Time: **10sec - 8min**
 Απόσταση Ανίχνευσης / Detection Distance: **6-8m**
 Υλικό / Material: **Αλουμίνιο & Γυαλί / Aluminium & Glass**

Με τηλεχειριστήριο (περιλαμβάνει μπαταρίες) / **With remote control** (batteries included)

Ηλιακό Πάνελ / Solar Panel: **5V 25W**
 Διαστάσεις / Dimensions: **360x400x20mm**
 Βάρος / Weight: **0,800kg**

Τύπος Μπαταρίας / Battery Type: **Lithium 3.2V 18000mAh**
 Charging Time: **4-5h**
 Discharging Time: **10-20h**

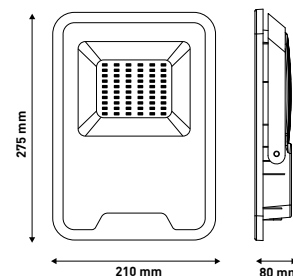

Max 6-8m at 25°C
 DETECTION DISTANCE

MICROWAVE SENSOR **-25 | +45 °C** **COLOR WHITE** **30.000h** **ON OFF 15.000** **IP66** **2 YEARS WARRANTY**

CODE	BARCODE	WATT	KELVIN	DIMENSIONS	WEIGHT	PACKING	MOQ	PRICE (€)
147-69593	5207227068836	30	6500	275x210x80mm	4.70kg	1/5	1	132,85

ΠΡΟΒΟΛΕΑΣ LED SMD ΗΛΙΑΚΟΣ PROJECTOR LED SMD SOLAR



Volt: **5V DC** • LED Type: **SMD2835**
 Γωνία Δέσμης Φωτός / Beam Angle: **120°**
 Start Time: **0,5sec** • CRI > **80** • IK07
 Καλώδιο / Wire: **2000mm 2x1mm²**
 Υλικό / Material: **Αλουμίνιο & Γυαλί** /
Aluminium & Glass

Με τηλεχειριστήριο (περιλαμβάνει μπαταρίες) /
With remote control (baterries included)

-25 | +45 °C
 COLOR DARK GREY
 30.000h
 ON OFF 15.000
 IP65
 3 YEARS WARRANTY

CODE	BARCODE	WATT	LUMEN	KELVIN	DIMENSIONS	WEIGHT	PACKING	MOQ	PRICE (€)
147-69580	5207227158834	20	1100	4000	210x176x42mm	13.0kg	1/5	1	57,65
147-69581	5207227158841	50	2750	4000	210x176x43mm	13.0kg	1/5	1	59,85

Ηλιακό Πάνελ / Solar Panel: **5V 10W** • Διαστάσεις / Dimensions: **250x205x15mm** • Βάρος / Weight: **1.200kg**
 Τύπος Μπαταρίας / Battery Type: **Lithium 3.2V 6000mAh** • Charging Time: **5-6h** • Discharging Time: **10-12h**



CODE	BARCODE	WATT	LUMEN	KELVIN	DIMENSIONS	WEIGHT	PACKING	MOQ	PRICE (€)
147-69582	5207227158858	100	5500	4000	270x211x43mm	20.0kg	1/5	1	83,45

Ηλιακό Πάνελ / Solar Panel: **5V 15W** • Διαστάσεις / Dimensions: **290x350x15mm** • Βάρος / Weight: **1.200kg**
 Τύπος Μπαταρίας / Battery Type: **Lithium 3.2V 15000mAh** • Charging Time: **5-6h** • Discharging Time: **10-12h**



ΠΡΟΒΟΛΕΑΣ LED SMD ΗΛΙΑΚΟΣ PROJECTOR LED SMD SOLAR



Volt: **5V DC** • LED Type: **SMD2835**
 Γωνία Δέσμης Φωτός / Beam Angle: **120°**
 Start Time: **0,5sec** • CRI > **80** • IK07
 Καλώδιο / Wire: **2000mm 2x1mm²**
 Υλικό / Material: **Αλουμίνιο & Γυαλί / Aluminium & Glass**

Με τηλεχειριστήριο (περιλαμβάνει μπαταρίες) /
With remote control (batteries included)

-25 | +45 °C
 COLOR DARK GREY
 30.000h
 ON OFF 15.000
 IP65
 3 YEARS WARRANTY

CODE	BARCODE	WATT	LUMEN	KELVIN	DIMENSIONS	WEIGHT	PACKING	MOQ	PRICE (€)
147-69583	5207227158865	200	11000	4000	351x284x43mm	24.0kg	1/4	1	112,80

Ηλιακό Πάνελ / Solar Panel: **5V 20W** • Διαστάσεις / Dimensions: **350x350x15mm** • Βάρος / Weight: **3.200kg**
 Τύπος Μπαταρίας / Battery Type: **Lithium 3.2V 20000mAh** • Charging Time: **5-6h** • Discharging Time: **10-12h**



CODE	BARCODE	WATT	LUMEN	KELVIN	DIMENSIONS	WEIGHT	PACKING	MOQ	PRICE (€)
147-69584	5207227158872	300	16500	4000	351x284x43mm	16.0kg	1/3	1	142,60

Ηλιακό Πάνελ / Solar Panel: **5V 30W** • Διαστάσεις / Dimensions: **350x530x15mm** • Βάρος / Weight: **3.500kg**
 Τύπος Μπαταρίας / Battery Type: **Lithium 3.2V 30000mAh** • Charging Time: **5-6h** • Discharging Time: **10-12h**



CODE	BARCODE	WATT	LUMEN	KELVIN	DIMENSIONS	WEIGHT	PACKING	MOQ	PRICE (€)
147-69585	5207227158889	400	22000	4000	395x319x63mm	19.0kg	1/2	1	198,65

Ηλιακό Πάνελ / Solar Panel: **5V 40W** • Διαστάσεις / Dimensions: **670x445x25mm** • Βάρος / Weight: **3.500kg**
 Τύπος Μπαταρίας / Battery Type: **Lithium 3.2V 40000mAh** • Charging Time: **5-6h** • Discharging Time: **10-12h**



CODE	BARCODE	WATT	LUMEN	KELVIN	DIMENSIONS	WEIGHT	PACKING	MOQ	PRICE (€)
147-69586	5207227160448	500	27500	4000	395x319x63mm	25.0kg	1/2	1	228,45

Ηλιακό Πάνελ / Solar Panel: **5V 50W** • Διαστάσεις / Dimensions: **670x445x25mm** • Βάρος / Weight: **3.500kg**
 Τύπος Μπαταρίας / Battery Type: **Lithium 3.2V 50000mAh** • Charging Time: **5-6h** • Discharging Time: **10-12h**





Προβολείς LED
εξωτερικού χώρου
επαγγελματικής χρήσης

Flood Lights LED
for outdoor professional use

ΠΡΟΒΟΛΕΑΣ LED SMD MODULAR PROJECTOR LED SMD MODULAR



1345x483x296mm

Volt: **100-305V 50/60Hz** • LED Type: **SMD3030**
 Γωνία Δέσμης Φωτός / Beam Angle: **30°**
 Ενεργειακή Κλάση / Energy Class: **E**
 Start Time: **0,5sec** • PF > **0.98** • CRI > **70** • IK08
 Καλώδιο / Wire: **3x1.5mm²**
 Υλικό / Material: **Αλουμίνιο / Aluminium**



GROUNDING
 FLICKER FREE
 Lm/W 130
 -30 | +50 °C
 CLASS I
 50.000h
 ON OFF 25.000
 IP66
 5 YEARS WARRANTY

CODE	BARCODE	WATT	AMPERAGE	KELVIN	WEIGHT	COLOR	PACKING	MOQ	PRICE (€)
146-69100	5207227035319	250	115V/2,2A - 230V/1,1A	5700	5.960kg	BLACK	1/1	1	366,45
146-69101	5207227035326	250	115V/2,2A - 230V/1,1A	4000	5.960kg	BLACK	1/1	1	366,45
146-69103	5207227328503	250	115V/2,2A - 230V/1,1A	5700	5.960kg	BLACK	1/1	1	394,80
146-69104	5207227199301	250	115V/2,2A - 230V/1,1A	4000	5.960kg	BLACK	1/1	1	394,80

ΒΑΣΕΙΣ ΠΡΟΒΟΛΕΑ MODULAR BRACKET ARMS FOR MODULAR PROJECTOR



146-69110



146-69111



146-69112



146-69113



Υλικό / Material:
Αλουμίνιο / Aluminium

COLOR
 BLACK
 5 YEARS WARRANTY

CODE	BARCODE	TYPE	WATT	WEIGHT	PACKING	MOQ	PRICE (€)
146-69110	5207227035333	ΜΟΝΗ / SINGLE TRUNNION	250	1.0kg	1/1	1	26,85
146-69111	5207227035340	ΔΙΠΛΗ / DOUBLE TRUNNION	500	7.200kg	1/1	1	308,80
146-69112	5207227035357	ΤΡΙΠΛΗ / TRIPLE TRUNNION	750	8.900kg	1/1	1	392,65
146-69113	5207227035364	ΤΕΤΡΑΠΛΗ / QUADRUPLE TRUNNION	1000	13.650kg	1/1	1	412,50
146-69114	5207227124242	ΠΕΝΤΑΠΛΗ / FIVEFOLD TRUNNION	1250	10.00kg	1/1	1	722,45

ΒΑΣΕΙΣ ΠΡΟΒΟΛΕΑ MODULAR BRACKET ARMS FOR MODULAR PROJECTOR



146-69115



ΓΙΑ ΧΡΗΣΗ ΣΕ ΠΑΡΚΙΝΚ /
SUITABLE FOR PARKING

146-69116

Υλικό / Material:

Αλουμίνιο / Aluminium

COLOR
BLACK

5
YEARS
WARRANTY

CODE	BARCODE	TYPE	WATT	DIMENSIONS	WEIGHT	PACKING	MOQ	PRICE (€)
146-69115	5207227035371	ΤΡΙΠΛΗ / TRIPLE KNUCKLE	750	545x289x78mm	7.9kg	1/1	1	66,70
146-69116	5207227035388	ΤΕΤΡΑΠΛΗ / QUADRUPLE LUMOSA TINY	1000	Ø512x123mm	6.0kg	1/1	1	122,60

ΛΕΙΖΕΡ ΡΥΘΜΙΣΗΣ ΠΡΟΒΟΛΕΑ LAZER FOR ADJUSTMENT MODULAR PROJECTOR



Volt: **3.7V DC**

Μπαταρία / Battery: **16340**

Υλικό / Material: Αλουμίνιο / Aluminium

-10 | +50 °C

COLOR
BLACK

2
YEARS
WARRANTY

CODE	BARCODE	TYPE	WATT	WEIGHT	PACKING	MOQ	PRICE (€)
146-69117	5207227035395	ΠΕΝΤΑΠΛΗ / FIVEFOLD TRUNNION	250	0.230kg	1/1	1	88,75



ΠΡΟΒΟΛΕΑΣ LED SMD MODULAR PROJECTOR LED SMD MODULAR



NEW



309.5x214.5x115mm

Volt: **100-277V 50/60Hz**
 LED Type: **SMD5050**
 Γωνία Δέσμης Φωτός / Beam Angle: **60°**
 Ενεργειακή Κλάση / Energy Class: **C**
 Start Time: **0,5sec / 230V AC, 1.2sec / 115V AC**
 PF > **0.95** • CRI > **70** • IK10
 Καλώδιο / Wire: **3x1.0mm²**
 Υλικό / Material: **Αλουμίνιο / Aluminium**

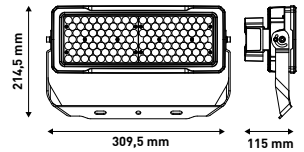

- GROUNDING
- FLICKER FREE
- NON DIMMABLE
- 30 | +50 °C
- CLASS I
- 3,15kg
- COLOR BLACK
- 50.000h
- ON OFF 15.000
- IP66
- 5 YEARS WARRANTY
- >8m INSTALLATION HEIGHT

CODE	BARCODE	WATT	LUMEN/WATT	AMPERAGE	KELVIN	PACKING	MOQ	PRICE (€)
146-69152	5207227275968	120	185	115V/1A - 230V/0.53A	6000	1/1	1	265,85
146-69153	5207227275975	120	185	115V/1A - 230V/0.53A	4000	1/1	1	265,85



NEW



358x300x155mm

Volt: **100-277V 50/60Hz**
 LED Type: **SMD5050**
 Γωνία Δέσμης Φωτός / Beam Angle: **60°**
 Ενεργειακή Κλάση / Energy Class: **C**
 Start Time: **0,5sec / 230V AC, 1.2sec / 115V AC**
 PF > **0.95** • CRI > **70** • IK10
 Καλώδιο / Wire: **3x1.0mm²**
 Υλικό / Material: **Αλουμίνιο / Aluminium**

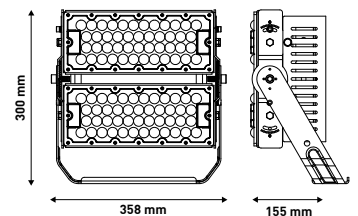

- GROUNDING
- FLICKER FREE
- NON DIMMABLE
- 30 | +50 °C
- CLASS I
- 6,85kg
- COLOR BLACK
- 50.000h
- ON OFF 15.000
- IP66
- 5 YEARS WARRANTY
- >8m INSTALLATION HEIGHT

CODE	BARCODE	WATT	LUMEN/WATT	AMPERAGE	KELVIN	PACKING	MOQ	PRICE (€)
146-69157	5207227275982	240	185	115V/2A - 230V/1.06A	6000	1/1	1	482,60
146-69158	5207227275999	240	185	115V/2A - 230V/1.06A	4000	1/1	1	485,60

ΠΡΟΒΟΛΕΑΣ LED SMD MODULAR PROJECTOR LED SMD MODULAR



358x440x155mm

Volt: **100-277V 50/60Hz**

LED Type: **SMD5050**

Γωνία Δέσμης Φωτός / Beam Angle: **60°**

Ενεργειακή Κλάση / Energy Class: **C**

Start Time: **0,5sec / 230V AC, 1,2sec / 115V AC**

PF > **0.95** • CRI > **70** • IK10

Καλώδιο / Wire: **3x1.0mm²**

Υλικό / Material: **Αλουμίνιο / Aluminium**

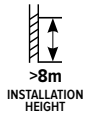
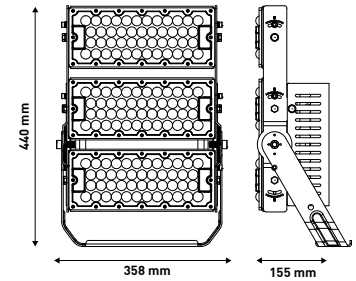

CODE	BARCODE	WATT	LUMEN/WATT	AMPERAGE	KELVIN	PACKING	MOQ	PRICE (€)
146-69159	5207227276002	300	185	115V/2.63A - 230V/1.32A	6000	1/1	1	688,80
146-69160	5207227276019	300	185	115V/2.63A - 230V/1.32A	4000	1/1	1	688,80



358x580x155mm

Volt: **100-277V 50/60Hz**

LED Type: **SMD5050**

Γωνία Δέσμης Φωτός / Beam Angle: **40°**

Ενεργειακή Κλάση / Energy Class: **C**

Start Time: **0,5sec / 230V AC, 1,2sec / 115V AC**

PF > **0.95** • CRI > **70** • IK10

Καλώδιο / Wire: **3x1.0mm²**

Υλικό / Material: **Αλουμίνιο / Aluminium**

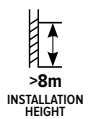
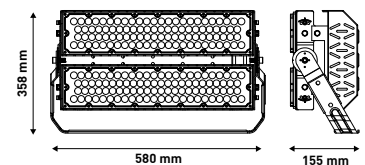

CODE	BARCODE	WATT	LUMEN/WATT	AMPERAGE	KELVIN	PACKING	MOQ	PRICE (€)
146-69163	5207227276026	480	185	115V/4A - 230V/2.12A	6000	1/1	1	940,95
146-69164	5207227276033	480	185	115V/4A - 230V/2.12A	4000	1/1	1	940,95

ΠΡΟΒΟΛΕΑΣ LED SMD MODULAR PROJECTOR LED SMD MODULAR



NEW



596x478x188mm

Volt: **100-277V 50/60Hz** • LED Type: **SMD5050**
 Γωνία Δέσμης Φωτός / Beam Angle: **40°**
 Ενεργειακή Κλάση / Energy Class: **C**
 Start Time: **0,5sec / 230V AC, 1.2sec / 115V AC**
 PF > **0.95** • CRI > **70** • IK10
 Καλώδιο / Wire: **3x1.0mm²**
 Υλικό / Material: **Αλουμίνιο / Aluminium**

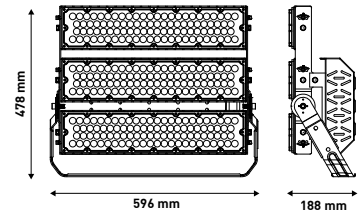

- GROUNDING
- FLICKER FREE
- NON DIMMABLE
- 30 | +50 °C
- CLASS I
- 15,85kg
- COLOR BLACK
- 50.000h
- ON OFF 15.000
- IP66
- 5 YEARS WARRANTY
- >8m INSTALLATION HEIGHT

CODE	BARCODE	WATT	LUMEN/WATT	AMPERAGE	KELVIN	PACKING	MOQ	PRICE (€)
146-69165	5207227276040	600	185	115V/5.26A - 230V/2.65A	6000	1/1	1	1.207,85
146-69166	5207227276057	600	185	115V/5.26A - 230V/2.65A	4000	1/1	1	1.207,85
146-69167	5207227276064	720	185	115V/6A - 230V/3.18A	6000	1/1	1	1.222,00
146-69168	5207227276071	720	185	115V/6A - 230V/3.18A	4000	1/1	1	1.222,00



NEW



596x627x188mm

Volt: **100-277V 50/60Hz** • LED Type: **SMD5050**
 Γωνία Δέσμης Φωτός / Beam Angle: **25°**
 Ενεργειακή Κλάση / Energy Class: **C**
 Start Time: **0,5sec / 230V AC, 1.2sec / 115V AC**
 PF > **0.95** • CRI > **70** • IK10
 Καλώδιο / Wire: **3x1.0mm²**
 Υλικό / Material: **Αλουμίνιο / Aluminium**

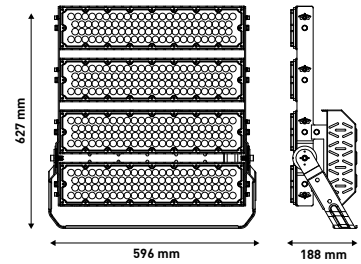

- GROUNDING
- FLICKER FREE
- NON DIMMABLE
- 30 | +50 °C
- CLASS I
- 20.15kg
- COLOR BLACK
- 50.000h
- ON OFF 15.000
- IP66
- 5 YEARS WARRANTY
- >8m INSTALLATION HEIGHT

CODE	BARCODE	WATT	LUMEN/WATT	AMPERAGE	KELVIN	PACKING	MOQ	PRICE (€)
146-69171	5207227276088	1000	185	115V/8.5A - 230V/4.5A	6000	1/1	1	1.516,00
146-69172	5207227276095	1000	185	115V/8.5A - 230V/4.5A	4000	1/1	1	1.516,00

ΠΡΟΒΟΛΕΑΣ LED SMD MODULAR PROJECTOR LED SMD MODULAR



596x775x188mm

Volt: **100-277V 50/60Hz** • LED Type: **SMD5050**
 Γωνία Δέσμης Φωτός / Beam Angle: **25°**
 Ενεργειακή Κλάση / Energy Class: **C**
 Start Time: **0,5sec / 230V AC, 1.2sec / 115V AC**
 PF > **0.95** • CRI > **70** • IK10
 Καλώδιο / Wire: **3x1.0mm²**
 Υλικό / Material: **Αλουμίνιο / Aluminium**

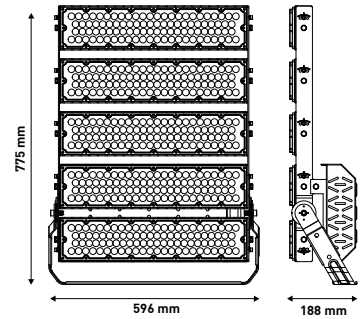

- GROUNDING
- FLICKER FREE
- NON DIMMABLE
- 30 | +50 °C
- CLASS I
- 24.3kg
- COLOR BLACK
- 50.000h
- ON OFF 15.000
- IP66
- 5 YEARS WARRANTY
- >8m INSTALLATION HEIGHT

CODE	BARCODE	WATT	LUMEN/WATT	AMPERAGE	KELVIN	PACKING	MOQ	PRICE (€)
146-69173	5207227276101	1200	185	115V/10.6A - 230V/5.3A	6000	1/1	1	1.822,00
146-69174	5207227276118	1200	185	115V/10.6A - 230V/5.3A	4000	1/1	1	1.822,00



596x923x188mm

Volt: **100-277V 50/60Hz** • LED Type: **SMD5050**
 Γωνία Δέσμης Φωτός / Beam Angle: **25°**
 Ενεργειακή Κλάση / Energy Class: **C**
 Start Time: **0,5sec / 230V AC, 1.2sec / 115V AC**
 PF > **0.95** • CRI > **70** • IK10
 Καλώδιο / Wire: **3x1.0mm²**
 Υλικό / Material: **Αλουμίνιο / Aluminium**

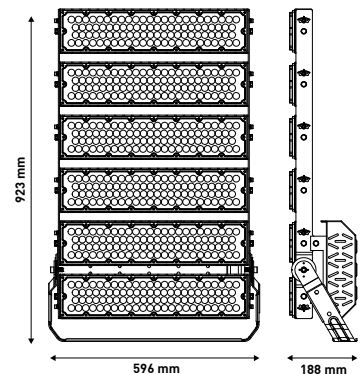

- GROUNDING
- FLICKER FREE
- NON DIMMABLE
- 30 | +50 °C
- CLASS I
- 28.0kg
- COLOR BLACK
- 50.000h
- ON OFF 15.000
- IP66
- 5 YEARS WARRANTY
- >8m INSTALLATION HEIGHT

CODE	BARCODE	WATT	LUMEN/WATT	AMPERAGE	KELVIN	PACKING	MOQ	PRICE (€)
146-69175	5207227276125	1440	185	115V/12A - 230V/6.4A	6000	1/1	1	2.287,00
146-69176	5207227276132	1440	185	115V/12A - 230V/6.4A	4000	1/1	1	2.287,00

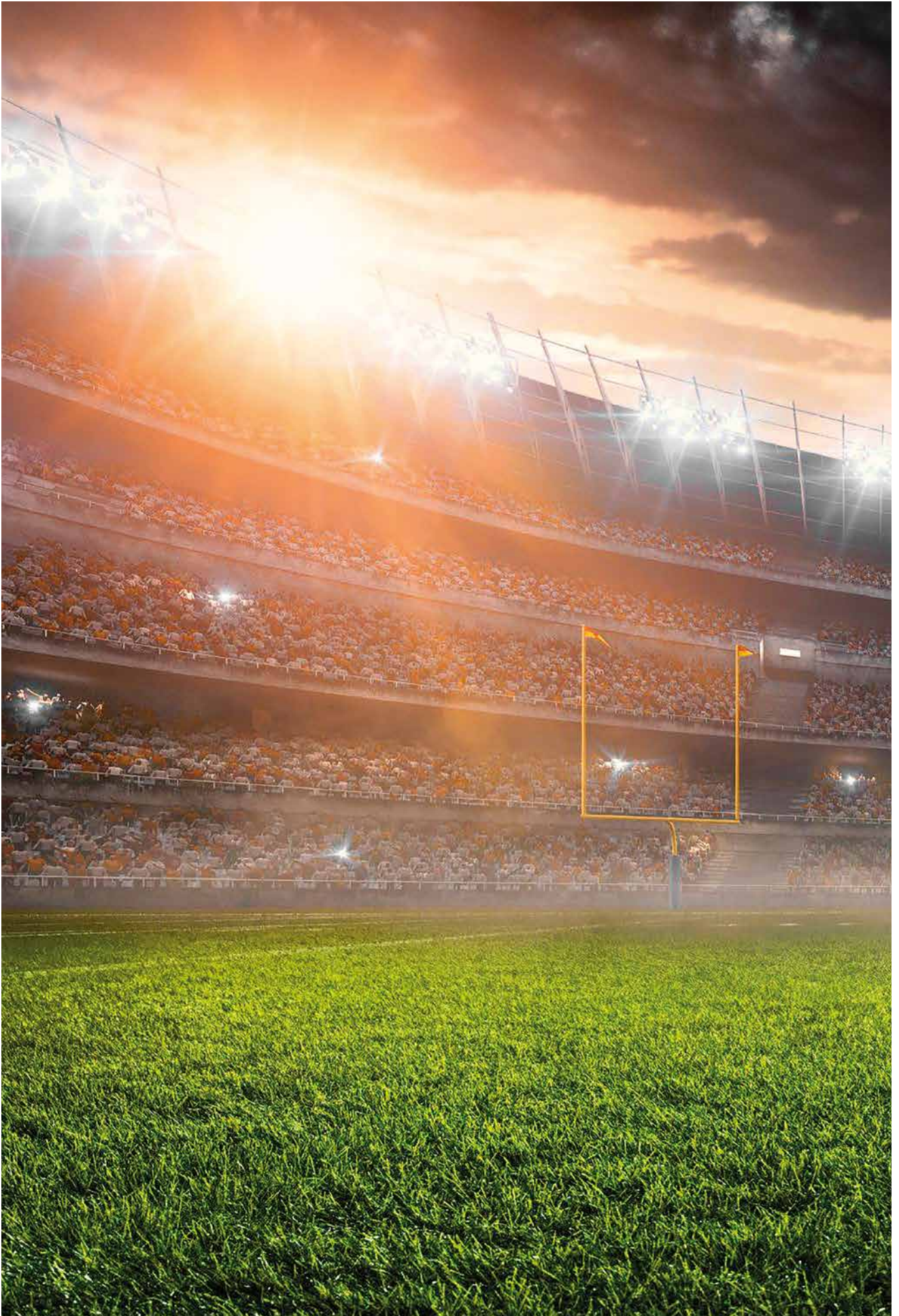

ΠΡΟΒΟΛΕΑΣ LED SMD PROJECTOR LED SMD

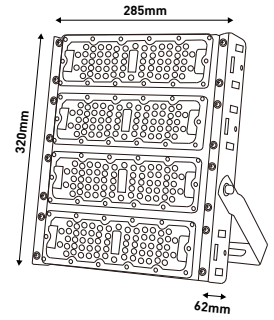

320x285x62mm

Volt: **100-240V 50/60Hz** • LED Type: **SMD3030**
 Ένταση ρεύματος / Amperage: **950mA**
 Γωνία Δέσμης Φωτός / Beam Angle: **90°**
 Ενεργειακή Κλάση / Energy Class: **E**
 Start Time: **0,5sec** • PF > **0,90** • CRI > **80** • IK06
 Καλώδιο / Wire: **250mm 3x1mm²**
 Υλικό / Material: **Αλουμίνιο & PC / Aluminium & PC**

GROUNDING
 -25 | +40 °C
 CLASS I
 4,750kg
 50.000h
 ON OFF
 IP65
 2 YEARS WARRANTY

CODE	BARCODE	WATT	KELVIN	LUMEN/WATT	COLOR	PACKING	MOQ	PRICE (€)
146-69000	5207227110900	200	6500	120	BLACK	1/2	1	168,80
146-69001	5207227110917	200	5000	120	BLACK	1/2	1	168,80
146-69002	5207227110924	200	4000	120	BLACK	1/2	1	168,80

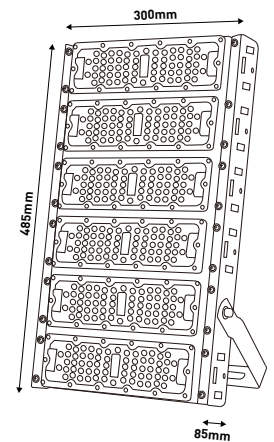

485x300x85mm

Volt: **100-240V 50/60Hz** • LED Type: **SMD3030**
 Ένταση ρεύματος / Amperage: **1700mA**
 Γωνία Δέσμης Φωτός / Beam Angle: **90°**
 Ενεργειακή Κλάση / Energy Class: **E**
 Start Time: **0,5sec** • PF > **0,90** • CRI > **80** • IK06
 Καλώδιο / Wire: **250mm 3x1mm²**
 Υλικό / Material: **Αλουμίνιο & PC / Aluminium & PC**

GROUNDING
 -25 | +40 °C
 CLASS I
 6,0kg
 50.000h
 ON OFF
 IP65
 2 YEARS WARRANTY

CODE	BARCODE	WATT	KELVIN	LUMEN/WATT	COLOR	PACKING	MOQ	PRICE (€)
146-69003	5207227110931	300	6500	120	BLACK	1/2	1	254,60
146-69004	5207227110948	300	5000	120	BLACK	1/2	1	254,60
146-69005	5207227110955	300	4000	120	BLACK	1/2	1	254,60

ΠΡΟΒΟΛΕΑΣ LED SMD PROJECTOR LED SMD

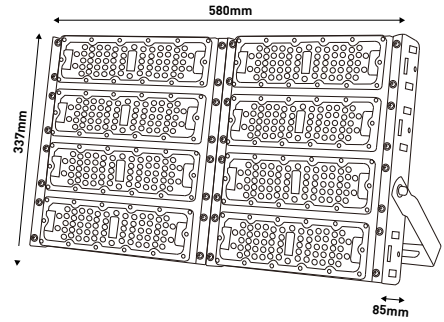

580x337x85mm

Volt: **100-240V 50/60Hz** • LED Type: **SMD3030**
 Ενταση ρεύματος / Amperage: **2100mA**
 Γωνία Δέσμης Φωτός / Beam Angle: **90°**
 Ενεργειακή Κλάση / Energy Class: **E**
 Start Time: **0,5sec** • PF > **0,90** • CRI > **80** • IK06
 Καλώδιο / Wire: **250mm 3x1mm²**
 Υλικό / Material: **Αλουμίνιο & PC / Aluminium & PC**

GROUNDING
 -25 | +40 °C
 CLASS I
 9,0kg
 50.000h
 ON OFF 50.000
 IP65
 2 YEARS WARRANTY

CODE	BARCODE	WATT	KELVIN	LUMEN/WATT	COLOR	PACKING	MOQ	PRICE (€)
146-69006	5207227110962	400	6500	120	BLACK	1/1	1	318,80
146-69007	5207227110979	400	5000	120	BLACK	1/1	1	318,80
146-69008	5207227110986	400	4000	120	BLACK	1/1	1	318,80

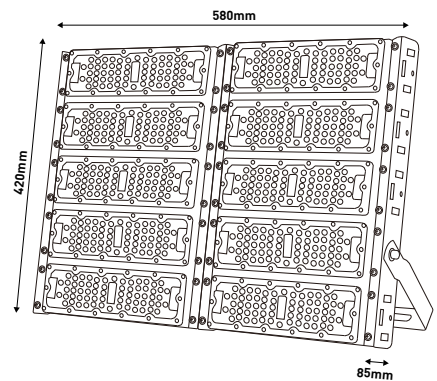

580x420x85mm

Volt: **100-240V 50/60Hz** • LED Type: **SMD3030**
 Ενταση ρεύματος / Amperage: **2400mA**
 Γωνία Δέσμης Φωτός / Beam Angle: **90°**
 Ενεργειακή Κλάση / Energy Class: **E**
 Start Time: **0,5sec** • PF > **0,90** • CRI > **80** • IK06
 Καλώδιο / Wire: **250mm 3x1mm²**
 Υλικό / Material: **Αλουμίνιο & PC / Aluminium & PC**

GROUNDING
 -25 | +40 °C
 CLASS I
 10,700kg
 50.000h
 ON OFF 50.000
 IP65
 2 YEARS WARRANTY

CODE	BARCODE	WATT	KELVIN	LUMEN/WATT	COLOR	PACKING	MOQ	PRICE (€)
146-69009	5207227110993	500	6500	120	BLACK	1/1	1	412,00
146-69010	5207227111006	500	5000	120	BLACK	1/1	1	412,00
146-69011	5207227111013	500	4000	120	BLACK	1/1	1	412,00

Φωτιστικά Δρόμου LED

Street Lights LED



ΦΩΤΙΣΤΙΚΟ ΔΡΟΜΟΥ LED SMD STREET LIGHT LED SMD



Volt: **85-265V 50/60Hz** • LED Type: **SMD2835**
 Γωνία Δέσμης Φωτός / Beam Angle: **120°x70°**
 Ενεργειακή Κλάση / Energy Class: **C**
 Start Time: **0,5sec** • PF > **0.90** • CRI > **70** • IK10
 Υλικό / Material: **Αλουμίνιο & Πλαστικό/ Aluminium & Plastic**
 Οπή Σύνδεσης / Connection Hole: **Ø60mm**
 Σύνδεση / Connection: **Καλώδιο / Wire**
 Καλώδιο / Wire: **200mm 3x1.0mm²**



Lm/W
160

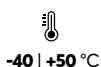

COLOR
GREY



ON OFF
15.000



CODE	BARCODE	WATT	AMPERAGE	KELVIN	DIMENSIONS	WEIGHT	PACKING	MOQ	PRICE (€)
146-57050	5207227301711	20	100mA	6500	570x200x145mm	1.5kg	1/1	1	53,20
146-57051	5207227301780	20	100mA	4000	570x200x145mm	1.5kg	1/1	1	53,20
146-57052	5207227301766	20	100mA	3000	570x200x145mm	1.5kg	1/1	1	53,20
146-57053	5207227301735	30	145mA	6500	570x200x145mm	1.5kg	1/1	1	54,70
146-57054	5207227301797	30	145mA	4000	570x200x145mm	1.5kg	1/1	1	54,70
146-57055	5207227301803	30	145mA	3000	570x200x145mm	1.5kg	1/1	1	54,70



Volt: **85-265V 50/60Hz** • LED Type: **SMD2835**
 Γωνία Δέσμης Φωτός / Beam Angle: **120°x70°**
 Ενεργειακή Κλάση / Energy Class: **C**
 Start Time: **0,5sec** • PF > **0.90** • CRI > **70** • IK10
 Υλικό / Material: **Αλουμίνιο & Πλαστικό/ Aluminium & Plastic**
 Οπή Σύνδεσης / Connection Hole: **Ø60mm**
 Σύνδεση / Connection: **Καλώδιο / Wire**
 Καλώδιο / Wire: **200mm 3x1.0mm²**



Lm/W
160

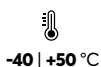

COLOR
GREY



ON OFF
15.000



CODE	BARCODE	WATT	AMPERAGE	KELVIN	DIMENSIONS	WEIGHT	PACKING	MOQ	PRICE (€)
146-57056	5207227301742	40	180mA	6500	605x200x145mm	1.7kg	1/1	1	56,95
146-57057	5207227301728	40	180mA	4000	605x200x145mm	1.7kg	1/1	1	56,95
146-57058	5207227301773	40	180mA	3000	605x200x145mm	1.7kg	1/1	1	56,95
146-57059	5207227301759	50	228mA	6500	605x200x145mm	1.7kg	1/1	1	60,75
146-57060	5207227301902	50	228mA	4000	605x200x145mm	1.7kg	1/1	1	60,75
146-57061	5207227301810	50	228mA	3000	605x200x145mm	1.7kg	1/1	1	60,75

ΦΩΤΙΣΤΙΚΟ ΔΡΟΜΟΥ LED SMD STREET LIGHT LED SMD



Volt: **85-265V 50/60Hz** • LED Type: **SMD2835**
 Γωνία Δέσμης Φωτός / Beam Angle: **120°x70°**
 Ενεργειακή Κλάση / Energy Class: **C**
 Start Time: **0,5sec** • PF > **0.90** • CRI > **70** • IK10
 Υλικό / Material: **Αλουμίνιο & Πλαστικό/ Aluminium & Plastic**
 Οπή Σύνδεσης / Connection Hole: **Ø60mm**
 Σύνδεση / Connection: **Καλώδιο / Wire**
 Καλώδιο / Wire: **200mm 3x1.0mm²**



Lm/W
160



COLOR
GREY



CODE	BARCODE	WATT	AMPERAGE	KELVIN	DIMENSIONS	WEIGHT	PACKING	MOQ	PRICE (€)
146-57062	5207227301834	80	370mA	6500	630x250x145mm	2.44kg	1/1	1	95,15
146-57063	5207227301841	80	370mA	4000	630x250x145mm	2.44kg	1/1	1	95,15
146-57064	5207227301827	80	370mA	3000	630x250x145mm	2.44kg	1/1	1	95,15
146-57065	5207227301889	100	460mA	6500	630x250x145mm	2.44kg	1/1	1	98,85
146-57066	5207227301858	100	460mA	4000	630x250x145mm	2.44kg	1/1	1	98,85
146-57067	5207227301896	100	460mA	3000	630x250x145mm	2.44kg	1/1	1	98,85



Volt: **85-265V 50/60Hz** • LED Type: **SMD2835**
 Γωνία Δέσμης Φωτός / Beam Angle: **120°x70°**
 Ενεργειακή Κλάση / Energy Class: **C**
 Start Time: **0,5sec** • PF > **0.90** • CRI > **70** • IK10
 Υλικό / Material: **Αλουμίνιο & Πλαστικό/ Aluminium & Plastic**
 Οπή Σύνδεσης / Connection Hole: **Ø60mm**
 Σύνδεση / Connection: **Καλώδιο / Wire**
 Καλώδιο / Wire: **200mm 3x1.0mm²**



Lm/W
160

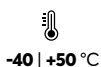

COLOR
GREY



CODE	BARCODE	WATT	AMPERAGE	KELVIN	DIMENSIONS	WEIGHT	PACKING	MOQ	PRICE (€)
146-57068	5207227301872	120	550mA	6500	630x250x145mm	2.44kg	1/1	1	108,40
146-57069	5207227301865	120	550mA	4000	630x250x145mm	2.44kg	1/1	1	108,40
146-57070	5207227301926	120	550mA	3000	630x250x145mm	2.44kg	1/1	1	108,40
146-57071	5207227301940	150	690mA	6500	730x240x145mm	2.44kg	1/1	1	134,85
146-57072	5207227301933	150	690mA	4000	730x240x145mm	2.44kg	1/1	1	134,85
146-57073	5207227301919	150	690mA	3000	730x240x145mm	2.44kg	1/1	1	134,85

ΦΩΤΙΣΤΙΚΟ ΔΡΟΜΟΥ LED SMD STREET LIGHT LED SMD



Volt: **120-240V 50/60Hz** • LED Type: **SMD2835**

Γωνία Δέσμης Φωτός / Beam Angle: **150°**

Ενεργειακή Κλάση / Energy Class: **D**

Start Time: **0,5sec** • PF > **0.95** • CRI > **80** • IK10

Υλικό / Material: **Αλουμίνιο & PC / Aluminium & PC**

Οπή Σύνδεσης / Connection Hole: **Ø60mm**

Σύνδεση / Connection: **Καλώδιο / Wire**

Καλώδιο / Wire: **300mm 3x1.0mm²**



Lm/W
140



-30 | +45 °C



CLASS I

COLOR
BLACK



50.000h

ON OFF
100.000



IP66



5 YEARS WARRANTY



4-10m
INSTALLATION
HEIGHT

CODE	BARCODE	WATT	AMPERAGE	KELVIN	DIMENSIONS	WEIGHT	PACKING	MOQ	PRICE (€)
146-57100	5207227301537	30	950mA	6500	523x146x53mm	12kg	1/5	1	179,85
146-57101	5207227301636	30	950mA	4000	523x146x53mm	12kg	1/5	1	179,85
146-57102	5207227301520	30	950mA	3000	523x146x53mm	12kg	1/5	1	179,85
146-57103	5207227301575	40	1.050mA	6500	523x146x53mm	12kg	1/5	1	199,45
146-57104	5207227301568	40	1.050mA	4000	523x146x53mm	12kg	1/5	1	199,45
146-57105	5207227301667	40	1.050mA	3000	523x146x53mm	12kg	1/5	1	199,45
146-57106	5207227301629	55	1.090mA	6500	523x146x53mm	12kg	1/5	1	208,25
146-57107	5207227300028	55	1.090mA	4000	523x146x53mm	12kg	1/5	1	208,25
146-57108	5207227301704	55	1.090mA	3000	523x146x53mm	12kg	1/5	1	208,25
146-57109	5207227301544	75	640mA	6500	629x174x53mm	12kg	1/3	1	285,45
146-57110	5207227300042	75	640mA	4000	629x174x53mm	12kg	1/3	1	285,45
146-57111	5207227301599	75	640mA	3000	629x174x53mm	12kg	1/3	1	285,45
146-57112	5207227301650	100	820mA	6500	629x174x53mm	12kg	1/3	1	290,65
146-57113	5207227301674	100	820mA	4000	629x174x53mm	12kg	1/3	1	290,65
146-57114	5207227301643	100	820mA	3000	629x174x53mm	12kg	1/3	1	290,65
146-57115	5207227301698	120	1.130mA	6500	629x174x53mm	12kg	1/3	1	304,55
146-57116	5207227301582	120	1.130mA	4000	629x174x53mm	12kg	1/3	1	304,55
146-57117	5207227301605	120	1.130mA	3000	629x174x53mm	12kg	1/3	1	304,55
146-57118	5207227301681	150	1.220mA	6500	724x194x82mm	15kg	1/3	1	359,75
146-57119	5207227301612	150	1.220mA	4000	724x194x82mm	15kg	1/3	1	359,75
146-57120	5207227301551	150	1.220mA	3000	724x194x82mm	15kg	1/3	1	359,75

ΦΩΤΙΣΤΙΚΑ ΔΡΟΜΟΥ ΗΛΙΑΚΑ ΜΕ ΑΝΙΧΝΕΥΤΗ ΚΙΝΗΣΗΣ LED SMD STREET LIGHTS SOLAR WITH MOVEMENT SENSOR LED SMD



Volt: **6V DC** • LED Type: **SMD5730**
Γωνία Δέσμης Φωτός / Beam Angle: **120°**
Start Time: **0,1sec** • CRI > **80** • IK07
Sensor Working Time: **10sec - 8min**
Υλικό / Material: **Αλουμίνιο / Aluminium**

Ηλιακό Πάνελ / Solar Panel: **6V 9W**
Οπή Σύνδεσης / Connection Hole: **Ø48mm**

Τύπος Μπαταρίας / Battery Type: **Lithium 3.2V**
9000mAh / 12000mAh
Charging Time: **5-6h**
Discharging Time: **12h**



Σε αναμονή λειτουργίας
το φωτιστικό λειτουργεί στο 30% και
σε περίπτωση ανίχνευσης στο 100% /

In Standby mode
it functions at 30%, and
in case of detection at 100%

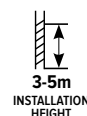
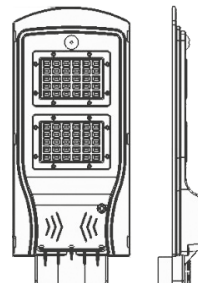

CODE	BARCODE	WATT	FULL OPERATION	STAND BY	KELVIN	DIMENSIONS	WEIGHT	PACKING	MOQ	PRICE (€)
200-57803	5207227122804	40	3400lm	1020lm	6000	495x240x70mm	1.8kg	1/5	1	76,85
200-57804	5207227107221	40	3400lm	1020lm	4000	495x240x70mm	1.8kg	1/5	1	76,85
200-57808	5207227107214	60	5100lm	1530lm	6000	610x260x70mm	2.5kg	1/5	1	93,75
200-57809	5207227107238	60	5100lm	1530lm	4000	610x260x70mm	2.5kg	1/5	1	93,75



Volt: **6V DC** • LED Type: **SMD5730**
Γωνία Δέσμης Φωτός / Beam Angle: **120°**
Start Time: **0,1sec** • CRI > **70** • IK03
Sensor Working Time: **10sec - 8min**
Υλικό / Material: **ABS**

Ηλιακό Πάνελ / Solar Panel: **6V 6W / 9W / 12W**
Οπή Σύνδεσης / Connection Hole: **Ø48mm**

Τύπος Μπαταρίας / Battery Type: **Lithium 3.2V**
5000mAh / 9000mAh / 10000mAh
Charging Time: **5-7h**
Discharging Time: **12-16h**



Σε αναμονή λειτουργίας
το φωτιστικό λειτουργεί στο 30% και
σε περίπτωση ανίχνευσης στο 100% /

In Standby mode
it functions at 30%, and
in case of detection at 100%

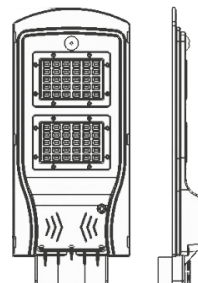

CODE	BARCODE	WATT	FULL OPERATION	STAND BY	KELVIN	DIMENSIONS	WEIGHT	PACKING	MOQ	PRICE (€)
200-57810	5207227329036	80	6800lm	2040lm	6000	390x194x55mm	1.3kg	1/10	1	38,85
200-57811	5207227122811	80	6800lm	2040lm	4000	390x194x55mm	1.3kg	1/10	1	38,85
200-57812	5207227122828	100	8500lm	2550lm	6000	485x219x55mm	1.9kg	1/10	1	54,65
200-57813	5207227329050	100	8500lm	2550lm	4000	485x219x55mm	1.9kg	1/10	1	54,65
200-57814	5207227329074	120	10200lm	3060lm	6000	623x238x55mm	2.4kg	1/10	1	68,85
200-57815	5207227329098	120	10200lm	3060lm	4000	623x238x55mm	2.4kg	1/10	1	68,85

ΦΩΤΙΣΤΙΚΟ ΔΡΟΜΟΥ LED SMD STREET LIGHT LED SMD

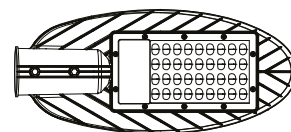

Volt: **220-240V 50/60Hz** • LED Type: **SMD2835**
 Γωνία Δέσμης Φωτός / Beam Angle: **150°**
 Ενεργειακή Κλάση / Energy Class: **E**
 Start Time: **0,5sec** • PF > **0.90** • CRI > **70** • IK08
 Καλώδιο / Wire: **300mm 3x1mm²**
 Υλικό / Material: **Αλουμίνιο & PC / Aluminium & PC**
 Οπή Σύνδεσης / Connection Hole: **Ø50mm**

Lm/W
110

-40 | +50 °C

CLASS II

COLOR
GREY

30.000h

ON OFF
25.000

IP65

2 YEARS WARRANTY

6-10m
INSTALLATION
HEIGHT

CODE	BARCODE	WATT	AMPERAGE	KELVIN	DIMENSIONS	WEIGHT	PACKING	MOQ	PRICE (€)
146-57000	5207227039416	30	150mA	6500	322x142x66mm	0.550kg	1/1	1	37,25
146-57001	5207227039423	30	150mA	4000	322x142x66mm	0.550kg	1/1	1	37,25
146-57002	5207227039430	30	150mA	3000	322x142x66mm	0.550kg	1/1	1	37,25
146-57003	5207227029967	50	250mA	6500	402x177x66mm	0.950kg	1/1	1	53,65
146-57004	5207227029974	50	250mA	4000	402x177x66mm	0.950kg	1/1	1	53,65
146-57005	5207227039447	50	250mA	3000	402x177x66mm	0.950kg	1/1	1	53,65
146-57006	5207227029981	70	500mA	6500	493x222x67.5mm	1.600kg	1/1	1	66,45
146-57007	5207227029998	70	500mA	4000	493x222x67.5mm	1.600kg	1/1	1	66,45
146-57008	5207227039454	70	500mA	3000	493x222x67.5mm	1.600kg	1/1	1	66,45
146-57009	5207227030000	100	500mA	6500	493x222x67.5mm	1.650kg	1/1	1	71,60
146-57010	5207227030017	100	500mA	4000	493x222x67.5mm	1.650kg	1/1	1	71,60
146-57011	5207227033100	100	500mA	3000	493x222x67.5mm	1.650kg	1/1	1	71,60



ΦΩΤΙΣΤΙΚΟ ΔΡΟΜΟΥ LED SMD STREET LIGHT LED SMD

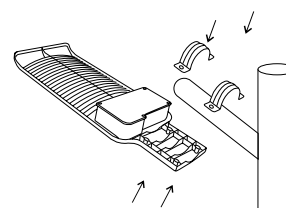

Volt: **85-265V 50/60Hz** • LED Type: **SMD2835**
 Γωνία Δέσμης Φωτός / Beam Angle: **120°**
 Ενεργειακή Κλάση / Energy Class: **D**
 Start Time: **0,5sec** • PF > **0.90** • CRI > **80** • IK08
 Καλώδιο / Wire: **300mm 3x1mm²**
 Υλικό / Material: **Αλουμίνιο & PC / Aluminium & PC**
 Οπή Σύνδεσης / Connection Hole:
Ø40mm (30-40W) & Ø50mm (60-150W)



Lm/W
140



CLASS I

COLOR
GREY

50.000h

ON OFF
25.000

IP65

2 YEARS
WARRANTY

6-10m
INSTALLATION
HEIGHT

CODE	BARCODE	WATT	AMPERAGE	KELVIN	DIMENSIONS	WEIGHT	PACKING	MOQ	PRICE (€)
146-57030	5207227073533	30	200mA	6500	330x115x52mm	0.650kg	1/1	1	35,85
146-57031	5207227073540	30	200mA	4000	330x115x52mm	0.650kg	1/1	1	35,85
146-57032	5207227073557	30	200mA	3000	330x115x52mm	0.650kg	1/1	1	35,85
146-57033	5207227073564	40	220mA	6500	350x115x52mm	0.650kg	1/1	1	46,90
146-57034	5207227073571	40	220mA	4000	350x115x52mm	0.650kg	1/1	1	46,90
146-57035	5207227073588	40	220mA	3000	350x115x52mm	0.650kg	1/1	1	46,90
146-57036	5207227073595	60	300mA	6500	430x150x62mm	1.050kg	1/1	1	56,80
146-57037	5207227073601	60	300mA	4000	430x150x62mm	1.050kg	1/1	1	56,80
146-57038	5207227073618	60	300mA	3000	430x150x62mm	1.050kg	1/1	1	56,80
146-57039	5207227073625	90	450mA	6500	450x150x62mm	1.150kg	1/1	1	83,45
146-57040	5207227073632	90	450mA	4000	450x150x62mm	1.150kg	1/1	1	83,45
146-57041	5207227073649	90	450mA	3000	450x150x62mm	1.150kg	1/1	1	83,45
146-57042	5207227073656	120	600mA	6500	565x180x72mm	1.500kg	1/1	1	106,45
146-57043	5207227073663	120	600mA	4000	565x180x72mm	1.500kg	1/1	1	106,45
146-57044	5207227073670	120	600mA	3000	565x180x72mm	1.500kg	1/1	1	106,45
146-57045	5207227073687	150	700mA	6500	590x180x72mm	1.850kg	1/1	1	134,60
146-57046	5207227073694	150	700mA	4000	590x180x72mm	1.850kg	1/1	1	134,60
146-57047	5207227073700	150	700mA	3000	590x180x72mm	1.850kg	1/1	1	134,60



ΦΩΤΙΣΤΙΚΟ ΔΡΟΜΟΥ SATURN LED SMD STREET LIGHT SATURN LED SMD



Volt: **100-277V 50/60Hz** • LED Type: **SMD2835**

Γωνία Δέσμης Φωτός / Beam Angle: **90°**

Ενεργειακή Κλάση / Energy Class: **D**

Start Time: **0,5sec** • PF > **0.95** • CRI > **70** • IK08

Υλικό / Material: **Αλουμίνιο, Πλαστικό & Γυαλί / Aluminium, Plastic & Glass**

Οπή Σύνδεσης / Connection Hole: **Ø80mm**

Καλώδιο / Wire: **500mm 3x1.0mm²**



Lm/W
150



-40 | +50 °C



CLASS I

COLOR
BLACK



50.000h



ON OFF
25.000



IP66



5 YEARS WARRANTY



3.5-6m
INSTALLATION HEIGHT

CODE	BARCODE	WATT	AMPERAGE	KELVIN	DIMENSIONS	WEIGHT	PACKING	MOQ	PRICE (€)
146-58000	5207227301988	30	630mA	5000	Ø422x539mm	6.8kg	1/1	1	298,80
146-58001	5207227302053	30	630mA	4000	Ø422x539mm	6.8kg	1/1	1	298,80
146-58002	5207227301971	30	630mA	3000	Ø422x539mm	6.8kg	1/1	1	298,80
146-58003	5207227302015	40	840mA	5000	Ø422x539mm	6.8kg	1/1	1	315,55
146-58004	5207227302008	40	840mA	4000	Ø422x539mm	6.8kg	1/1	1	315,55
146-58005	5207227302039	40	840mA	3000	Ø422x539mm	6.8kg	1/1	1	315,55
146-58006	5207227302022	60	1260mA	5000	Ø422x539mm	6.8kg	1/1	1	321,65
146-58007	5207227301995	60	1260mA	4000	Ø422x539mm	6.8kg	1/1	1	321,65
146-58008	5207227302046	60	1260mA	3000	Ø422x539mm	6.8kg	1/1	1	321,65
146-58009	5207227301964	90	1880mA	5000	Ø422x539mm	6.8kg	1/1	1	334,55
146-58010	5207227302060	90	1880mA	4000	Ø422x539mm	6.8kg	1/1	1	334,55
146-58011	5207227302077	90	1880mA	3000	Ø422x539mm	6.8kg	1/1	1	334,55

ΦΩΤΙΣΤΙΚΟ ΚΟΡΥΦΗΣ ΑΛΟΥΜΙΝΙΟΥ TOP TREE ALUMINIUM



Volt: **90-260V**

Γωνία Δέσμης Φωτός / Beam Angle: **90°**

Υλικό / Material: **Αλουμίνιο & Πλαστικό / Aluminium & Plastic**

Οπή Σύνδεσης / Connection Hole: **Ø70mm**

Σύνδεση / Connection: **Κλέμμα / Terminal Block**

E27
BASE



GROUNDING



-20 | +45 °C



IP65



2 YEARS WARRANTY



3.5-6m
INSTALLATION HEIGHT

CODE	BARCODE	WATT	DIMENSIONS	WEIGHT	COLOR	PACKING	MOQ	PRICE (€)
145-57550	5206139061386	Max 30 Led	380x380x370mm	2.3kg	DARK GREY	1/1	1	108,95

ΦΩΤΙΣΤΙΚΟ ΚΟΡΥΦΗΣ 3CCT LED VAC POST TOP MOUNTED 3CCT LED VAC



Wattage 4 options

Volt: **100-240V 50/60Hz** • LED Type: **SMD3030**
 3CCT: **3000K/4000K/5000K Selectable**
 Γωνία Δέσμης Φωτός / Beam Angle: **160°**
 Ενεργειακή Κλάση / Energy Class: **D**
 Start Time: **0,5sec** • PF > **0.95** • CRI > **70** • IK09
 Υλικό / Material: **Αλουμίνιο & PC / Aluminium & PC**
 Οπή Σύνδεσης / Connection Hole: **Ø60mm**
 Καλώδιο / Wire: **1500mm 3x1.0mm²**



GROUNDING
 -30 | +50 °C
 CLASS I
 COLOR BLACK
 54.000h
 ON OFF 100.000
 6.1kg
 IP66
 5 YEARS WARRANTY

CODE	BARCODE	WATT	AMPERAGE	LUMEN/W	KELVIN	DIMENSIONS	PACKING	MOQ	PRICE (€)
146-58021	5207227301957	12/20/30/40	88mA	135	3CCT	Φ371x420mm	1/1	1	423,45
146-58022	5207227269301	18/30/45/60	105mA	145	3CCT	Φ371x420mm	1/1	1	438,85

ΠΑΡΑΔΟΣΙΑΚΟ ΦΩΤΙΣΤΙΚΟ LED TRADITIONAL LED LIGHT



Volt: **100-277V 50/60Hz** • LED Type: **SMD3030**
 Γωνία Δέσμης Φωτός / Beam Angle: **120°**
 Ενεργειακή Κλάση / Energy Class: **D**
 Start Time: **0,5sec** • PF > **0.95** • CRI > **70** • IK08
 Υλικό / Material: **Αλουμίνιο, Πλαστικό & Γυαλί / Aluminium, Plastic & Glass**
 Οπή Σύνδεσης / Connection Hole: **Ø80mm**
 Καλώδιο / Wire: **300mm 3x1.0mm²**

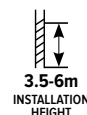

GROUNDING
 Lm/W 140
 -40 | +50 °C
 CLASS I
 COLOR BLACK
 50.000h
 ON OFF 25.000
 IP65
 5 YEARS WARRANTY

CODE	BARCODE	WATT	AMPERAGE	KELVIN	DIMENSIONS	WEIGHT	PACKING	MOQ	PRICE (€)
146-58012	5207227302176	30	670mA	5000	400x400x701mm	7.0kg	1/1	1	314,85
146-58013	5207227302183	30	670mA	4000	400x400x701mm	7.0kg	1/1	1	314,85
146-58014	5207227302145	30	670mA	3000	400x400x701mm	7.0kg	1/1	1	314,85
146-58015	5207227302121	40	900mA	5000	400x400x701mm	7.0kg	1/1	1	335,85
146-58016	5207227302190	40	900mA	4000	400x400x701mm	7.0kg	1/1	1	335,85
146-58017	5207227302169	40	900mA	3000	400x400x701mm	7.0kg	1/1	1	335,85
146-58018	5207227302138	60	1350mA	5000	400x400x701mm	7.0kg	1/1	1	355,45
146-58019	5207227302152	60	1350mA	4000	400x400x701mm	7.0kg	1/1	1	355,45
146-58020	5207227302206	60	1350mA	3000	400x400x701mm	7.0kg	1/1	1	355,45

ΦΩΤΙΣΤΙΚΟ ΚΑΠΕΛΑΚΙ ΒΡΑΧΙΩΝΟΣ STREET LIGHT



Volt: **220-240V 50/60Hz**

Σύνδεση / Connection: **Καλώδιο / Cable**

Υλικό / Material: **Αλουμίνιο / Aluminium**

E27 BASE
 GROUNDING
 -20 | +60 °C
 **IK06**
 **IP23**
 **2 YEARS WARRANTY**

CODE	BARCODE	WATT	DIMENSIONS	COLOR	WEIGHT	PACKING	MOQ	PRICE (€)
146-57900	5207227328954	max 30W Led	Ø300x1000x350mm	WHITE	1.2kg	1/1	1	68,85



Volt: **220-240V 50/60Hz**

Σύνδεση / Connection: **Καλώδιο / Cable**

Υλικό / Material: **Αλουμίνιο / Aluminium**

E27 BASE
 GROUNDING
 -20 | +60 °C
COLOR SILVER
 **IK06**
 **IP23**
 **2 YEARS WARRANTY**

CODE	BARCODE	WATT	DIMENSIONS	COLOR	WEIGHT	PACKING	MOQ	PRICE (€)
146-57901	5207227328961	max 30W Led	Ø200x1000x350mm	SILVER	1.2kg	1/1	1	59,65



Volt: **220-240V 50/60Hz**

Σύνδεση / Connection: **Καλώδιο / Cable**

Υλικό / Material: **Αλουμίνιο / Aluminium**

E27 BASE
 GROUNDING
 -20 | +60 °C
 **IK06**
 **IP23**
 **2 YEARS WARRANTY**

CODE	BARCODE	WATT	DIMENSIONS	COLOR	WEIGHT	PACKING	MOQ	PRICE (€)
146-57902	5207227328978	max 30W Led	Ø300x1000x350mm	SILVER	1.2kg	1/1	1	68,90

ΦΩΤΙΣΤΙΚΟ ΚΑΠΕΛΑΚΙ ΒΡΑΧΙΩΝΟΣ ΜΕ ΑΝΤΗΡΙΔΑ STREET LIGHT WITH REINFORCEMENT BAR



Volt: **220-240V 50/60Hz**

Σύνδεση / Connection: **Καλώδιο / Cable**

Υλικό / Material: **Αλουμίνιο / Aluminium**



CODE	BARCODE	WATT	DIMENSIONS	COLOR	WEIGHT	PACKING	MOQ	PRICE (€)
146-57903	5207227328985	max 30W Led	Ø300x1000x350mm	WHITE & GREEN	1.6kg	1/1	1	84,50

ΕΞΑΡΤΗΜΑΤΑ ACCESSORIES



Υλικό / Material: **Μεταλλικό / Metallic**

Χρώμα / Color: **Γαλβανική Επιμετάλλωση / Galvanic Plating**

CODE	BARCODE	PRODUCT DESCRIPTION	DIMENSIONS	WEIGHT	PACKING	MOQ	PRICE (€)
147-22410	5206139394101	ΒΡΑΧΙΟΝΕΣ 1M Ø42 "ERIBAN" BRACKET FOR STREET LIGHT Ø42 1m "ERIBAN"	Ø42x110mm	1,5kg	1/5	1	17,25
147-22419	5207227256400	ΒΡΑΧΙΟΝΕΣ 1M Ø48 "ERIBAN" BRACKET FOR STREET LIGHT Ø48 1m "ERIBAN"	Ø48x110mm	1,5kg	1/5	1	22,65
147-22411	5207227072352	ΒΡΑΧΙΟΝΕΣ 1M Ø60 "ERIBAN" BRACKET FOR STREET LIGHT 1m Ø60 "ERIBAN"	Ø60x110mm	3,5kg	1/1	1	30,25
147-22415	5207227123672	ΒΡΑΧΙΟΝΕΣ 2M Ø42 "ERIBAN" BRACKET FOR STREET LIGHT Ø42 2m "ERIBAN"	Ø42x200mm	2,1kg	1/5	1	33,45
147-22416	5207227123689	ΒΡΑΧΙΟΝΕΣ 2M Ø60 "ERIBAN" BRACKET FOR STREET LIGHT 2m Ø60 "ERIBAN"	Ø60x200mm	7,1kg	1/1	1	53,65
147-22430	5207227330100	ΑΝΤΑΠΤΟΡΑΣ ΒΡΑΧΙΟΝΑ Ø60 ΣΕ Ø60 ΚΑΙ ΓΩΝΙΑ 90° BRACKET ADAPTER Ø60 TO Ø60 WITH CORNER 90°	Ø60x255mm	0,83kg	1/1	1	32,85
147-22432	5207227330117	ΑΝΤΑΠΤΟΡΑΣ ΒΡΑΧΙΟΝΑ Ø60 ΣΕ Ø50 ΚΑΙ ΓΩΝΙΑ 90° BRACKET ADAPTER Ø60 TO Ø50 WITH CORNER 90°	Ø60x230mm	0,74kg	1/1	1	36,60
147-22434	5207227330124	ΑΝΤΑΠΤΟΡΑΣ ΒΡΑΧΙΟΝΑ Ø60 ΣΕ Ø60 BRACKET ADAPTER Ø60 TO Ø60	Ø60x175mm	0,39kg	1/1	1	32,40

ΧΩΝΕΥΤΟ ΦΩΤΙΣΤΙΚΟ LED ΓΙΑ BENZINAΔΙΚΑ LED RECESSED LIGHT FOR GAS STATIONS



400x400x76mm

Volt: **100-240V 50/60Hz** • LED Type: **SMD3030**

Ένταση ρεύματος / Amperage: **1440mA**

Γωνία Δέσμης Φωτός / Beam Angle: **120°**

Ενεργειακή Κλάση / Energy Class: **E**

Start Time: **1sec** • PF > **0.92** • CRI > **80** • IK07

Καλώδιο / Wire: **300mm 3x1mm²**

Υλικό / Material:

SPCC & Πολυκαρβονικό / SPCC & Polycarbonate

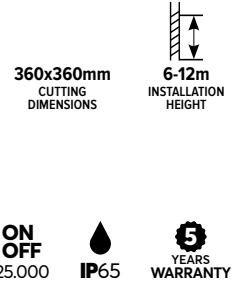

CODE	BARCODE	WATT	KELVIN	LUMEN/WATT	COLOR	PACKING	MOQ	PRICE (€)
147-56321	5207227059155	75	5000	130	BLACK	1/1	1	172,65

ΑΝΙΧΝΕΥΤΗΣ ΚΙΝΗΣΗΣ ΧΩΝΕΥΤΟΣ RECESSED MOVEMENT DETECTOR

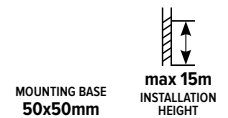

Ø80x70mm

Volt: **220-240V 50/60Hz**

Γωνία Ανίχνευσης /

Detection Angle: **220°**

Απόσταση Ανίχνευσης /

Detection Distance: **6-12m**

Υλικό / Material:

Πλαστικό & Μεταλλικό /

Plastic & Metallic

Όταν ανιχνευθεί κίνηση, αλλά το φως της ημέρας είναι επαρκές, το φως παραμένει σβηστό / When motion detected, but sufficient daylight, light remains OFF

Όταν ανιχνευθεί κίνηση σε ανεπαρκές φως ημέρας, το φως ανάβει / When motion detected, insufficient daylight, light ON

Μετά την τελευταία ανίχνευση, το φως θα μεταβαίνει στο επίπεδο που έχει ρυθμιστεί (10%, 20%, 30%, 50%) / After last detection, the light will be dimmed down to the stand-by dimming level (10%, 20%, 30%, 50%)



CODE	BARCODE	WATT	DIMENSIONS	COLOR	PACKING	MOQ	PRICE (€)
147-56322	5207227059162	1200	Ø80x70mm	GREY	1/1	1	75,15

The **reliable solution**
for demanding business spaces

Η αξιόπιστη λύση για απαιτητικούς επαγγελματικούς χώρους

Το απόλυτο φωτιστικό για μεγάλους επαγγελματικούς χώρους! Στιβαρή κατασκευή, 100.000 ώρες ζωής, πολλαπλές επιλογές ρύθμισης και ενεργειακή απόδοση συνθέτουν την αξιόπιστη λύση που θα υπηρετεί τις ανάγκες σας για πολλά χρόνια.

The ultimate light fixture for large business spaces! Robust construction, 100.000 hours of life, multiple setting options and energy efficiency make up the reliable solution that will serve your needs for many years.

- ▶ **Κορυφαία ενεργειακή απόδοση και άριστη φωτεινότητα μέχρι και 200Lm/W που καλύπτει και το πιο απαιτητικό επαγγελματικό περιβάλλον**

Top energy efficiency and excellent brightness up to 200Lm/W that covers even the most demanding professional environment

- ▶ **Διαχείριση θερμοκρασίας χρώματος 3CCT σε συνδυασμό με την επιλογή τριών διαφορετικών λειτουργιών ισχύος (W)**

3CCT color temperature management combined with the choice of three different operating power modes (wattage)

- ▶ **Εκδόσεις με υποστήριξη DALI για αποτελεσματική διαχείριση φωτός**

Versions with DALI support for efficient light management

*DALI: Digital Addressable Lighting Interface / Διεύθυνση ψηφιακής διεπαφής φωτισμού



ΚΑΜΠΑΝΑ LED SMD UFO 3CCT HIGH BAY LED SMD UFO 3CCT



3
CCT

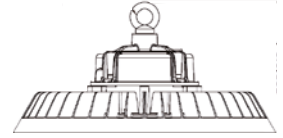

Wattage 3 options

NEW



Volt: **220-240V 50/60Hz** • LED Type: **SMD2835**
 3CCT: **3000K/4000K/6000K**
 Γωνία Δέσμης Φωτός / Beam Angle: **120°**
 Ενεργειακή Κλάση / Energy Class: **C**
 Start Time: **0,5sec** • PF > **0.90** • CRI > **80** • IK08
 Υλικό / Material: **Αλουμίνιο & PC / Aluminium & PC**
 Σύνδεση / Connection: **Καλώδιο / Wire**
 Καλώδιο / Wire: **300mm 3x1.0mm²**



Lm/W
160

-20 | +50 °C

CLASS I

COLOR
BLACK

100.000h

ON OFF
10.000

IP65

5 YEARS WARRANTY

5-12m
INSTALLATION
HEIGHT

CODE	BARCODE	WATT	AMPERAGE	KELVIN	DIMENSIONS	WEIGHT	PACKING	MOQ	PRICE (€)
145-67123	5207227073717	60-80-100	435mA	3CCT	Ø253x149mm	2.5kg	1/1	1	94,85
145-67124	5207227073724	100-120-150	435mA	3CCT	Ø253x149mm	2.5kg	1/1	1	104,65
145-67126	5207227073731	100-150-200	650mA	3CCT	Ø308x155mm	3.1kg	1/1	1	126,80



ΚΑΜΠΑΝΑ LED SMD UFO 3CCT HIGH BAY LED SMD UFO 3CCT



Wattage 3 options

Volt: **220-240V 50/60Hz** • LED Type: **SMD2835**

3CCT: **3000K/4000K/6000K**

Γωνία Δέσμης Φωτός / Beam Angle: **90°**

Ενεργειακή Κλάση / Energy Class: **B**

Start Time: **0,5sec** • PF > **0.90** • CRI > **70** • IK10

Υλικό / Material: **Αλουμίνιο & Πλαστικό / Aluminium & Plastic**

Σύνδεση / Connection: **Καλώδιο / Wire**

Καλώδιο / Wire: **300mm 3x1.5mm²**

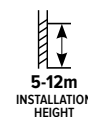

CODE	BARCODE	WATT	AMPERAGE	KELVIN	DIMENSIONS	WEIGHT	PACKING	MOQ	PRICE (€)
145-67130	5207227289507	60-80-100	480mA	3CCT	Ø310x125mm	1.9kg	1/1	1	114,45
145-67131	5207227289514	80-120-150	690mA	3CCT	Ø330x140mm	2.3kg	1/1	1	132,60
145-67132	5207227289521	100-150-200	920mA	3CCT	Ø380x140mm	2.8kg	1/1	1	162,40

ΚΑΜΠΑΝΑ LED SMD UFO DALI HIGH BAY LED SMD UFO DALI



Volt: **220-240V 50/60Hz** • LED Type: **SMD2835**

Γωνία Δέσμης Φωτός / Beam Angle: **90°**

Ενεργειακή Κλάση / Energy Class: **C**

Start Time: **0,5sec** • PF > **0.90** • CRI > **80** • IK10

Υλικό / Material: **Αλουμίνιο & Πλαστικό / Aluminium & Plastic**

Σύνδεση / Connection: **Καλώδιο / Wire**

Καλώδιο / Wire: **300mm 3x1.0mm²**

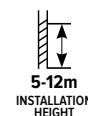

CODE	BARCODE	WATT	AMPERAGE	KELVIN	DIMENSIONS	WEIGHT	PACKING	MOQ	PRICE (€)
145-67135	5207227289477	100	480mA	4000	Ø310x125mm	1.9kg	1/1	1	161,65
145-67136	5207227289491	200	920mA	4000	Ø330x140mm	2.3kg	1/1	1	194,55

ΚΑΜΠΑΝΑ LED SMD UFO HIGH BAY LED SMD UFO



Volt: **220-240V 50/60Hz** • LED Type: **SMD2835**
 Γωνία Δέσμης Φωτός / Beam Angle: **90°**
 Ενεργειακή Κλάση / Energy Class: **C**
 Start Time: **0,5sec** • PF > **0.90** • CRI > **70** • IK10
 Υλικό / Material: **Αλουμίνιο & Πλαστικό / Aluminium & Plastic**
 Σύνδεση / Connection: **Καλώδιο / Wire**
 Καλώδιο / Wire: **300mm 3x1.5mm²**



Lm/W
160



COLOR
BLACK



ON OFF
15.000



5
YEARS
WARRANTY

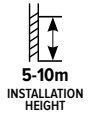

CODE	BARCODE	WATT	AMPERAGE	KELVIN	DIMENSIONS	WEIGHT	PACKING	MOQ	PRICE (€)
145-67138	5207227292217	200	920mA	4000	Ø330x140mm	2.3kg	1/1	1	117,85

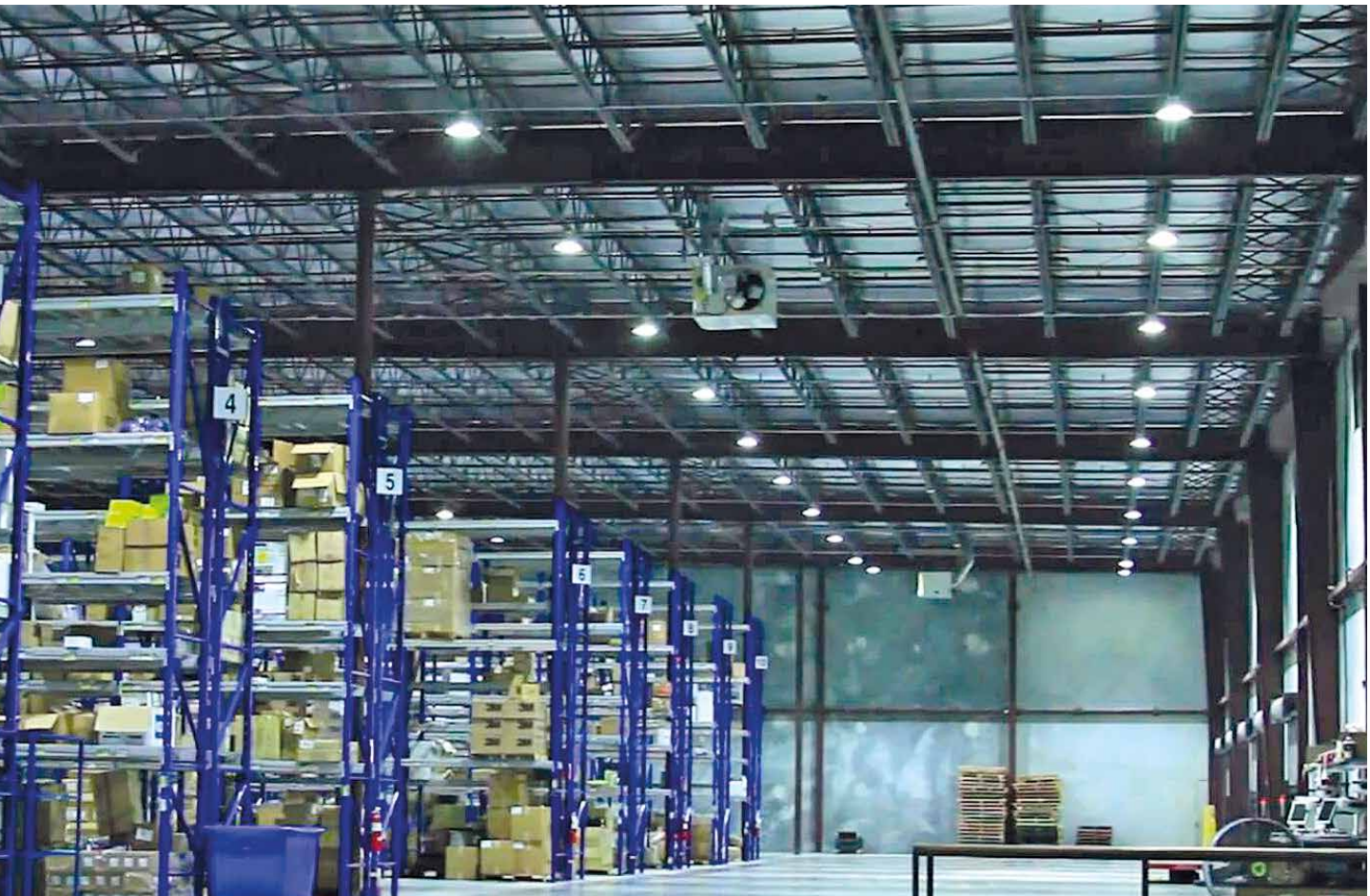

ΑΞΕΣΟΥΑΡ ΓΙΑ ΚΑΜΠΑΝΑ UFO HIGH BAY UFO ACCESSORIES

ΒΑΣΗ ΟΡΟΦΗΣ ΓΙΑ ΚΑΜΠΑΝΑ CEILING BASE FOR HIGH BAY

Υλικό / Material: **Αλουμίνιο / Aluminium**

COLOR
BLACK

5 YEARS WARRANTY



CODE	BARCODE	COLOR	WEIGHT	PACKING	MOQ	PRICE (€)
145-67143	5207227299254	BLACK	0.44kg	1/30	1	21,20

ΤΗΛΕΧΕΙΡΙΣΤΗΡΙΟ ΓΙΑ ΚΑΜΠΑΝΑ ΜΕ ΑΝΙΧΝΕΥΤΗ ΚΙΝΗΣΗΣ REMOTE CONTROL FOR HIGH BAY WITH MOVEMENT SENSOR

Τύπος Μπαταρίας / Battery type: **Ni-MH Alkaline 1.5V AAA**

Συνιστώνται 7 μπαταρίες / 7 batteries is recommended

Υλικό / Material: **Πλαστικό / Plastic**

COLOR
WHITE

5 YEARS WARRANTY



CODE	BARCODE	DIMENSIONS	WEIGHT	PACKING	MOQ	PRICE (€)
145-67144	5207227299261	116,5x55x13mm	0.05kg	1/20	1	22,60

ΑΝΙΧΝΕΥΤΗΣ ΚΙΝΗΣΗΣ MOVEMENT SENSOR

Volt: **5-24V DC 5.8GHz - 75MHz**

Γωνία Ανίχνευσης / Detection Angle: **360°**

Απόσταση Ανίχνευσης / Detection Distance: **6m**

Υλικό / Material: **Πλαστικό / Plastic**

MOTION SENSOR

IP65

COLOR
WHITE

5 YEARS WARRANTY



CODE	BARCODE	AMPERAGE	DIMENSIONS	WEIGHT	PACKING	MOQ	PRICE (€)
145-67145	5207227299278	33mA	Ø48x20mm	0.05kg	1/50	1	21,85

ΚΙΤ ΜΠΑΤΑΡΙΑΣ EMERGENCY BATTERY SET

Τύπος Μπαταρίας / Battery Type: **Λιθίου (3 ώρες) / Li-ion (3hours)**

Υλικό / Material: **Πλαστικό & Μεταλλικό / Plastic & Metallic**

Σύνδεση / Connection: **Καλώδιο / Wire**

-35 | +70 °C

CLASS II

COLOR
GREY

V
210-240V

ON OFF
25,000

IK08

IP65

3 YEARS WARRANTY



max 15m
INSTALLATION
HEIGHT

CODE	BARCODE	WATT	AMPERAGE	DIMENSIONS	WEIGHT	PACKING	MOQ	PRICE (€)
145-67146	5207227327650	40	200mA	280x166x100mm	1.8kg	1/50	1	466,00

ΚΑΜΠΑΝΑ LED SMD UFO HIGH BAY LED SMD UFO



Volt: **100-240V 50/60Hz** • LED Type: **SMD2835**
 Γωνία Δέσμης Φωτός / Beam Angle: **120°**
 Ενεργειακή Κλάση / Energy Class: **E**
 Start Time: **0,5sec** • PF > **0.90** • CRI > **80** • IK08
 Υλικό / Material: **Αλουμίνιο & PC / Aluminium & PC**
 Σύνδεση / Connection: **Καλώδιο / Wire**
 Καλώδιο / Wire: **300mm 3x1.0mm²**



Lm/W
120



-40 | +50 °C



CLASS II

COLOR
BLACK



30.000h

ON OFF
25.000



IP65



2 YEARS WARRANTY

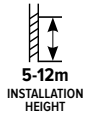

5-12m
INSTALLATION HEIGHT

CODE	BARCODE	WATT	AMPERAGE	KELVIN	DIMENSIONS	WEIGHT	PACKING	MOQ	PRICE (€)
145-67100	5207227028502	50	250mA	6500	Ø220x117mm	0.7kg	1/1	1	55,45
145-67101	5207227028519	50	250mA	4000	Ø220x117mm	0.7kg	1/1	1	55,45
145-67103	5207227028533	100	500mA	6500	Ø280x130mm	1.2kg	1/1	1	72,60
145-67104	5207227028540	100	500mA	4000	Ø280x130mm	1.2kg	1/1	1	72,60
145-67106	5207227028564	150	750mA	6500	Ø360x140mm	1.7kg	1/1	1	112,20
145-67107	5207227028571	150	750mA	4000	Ø360x140mm	1.7kg	1/1	1	112,20
145-67109	5207227028595	200	1000mA	6500	Ø420x160mm	2.4kg	1/1	1	143,40
145-67110	5207227028601	200	1000mA	4000	Ø420x160mm	2.4kg	1/1	1	143,40



Φωτιστικά πισίνας
και υποβρύχιο σποτ

Swimming pool lights
& Underwater spot light



ΦΩΤΙΣΤΙΚΟ ΠΙΣΙΝΑΣ LED SWIMMING POOL LED LIGHT



Volt: **12V AC / DC** • LED Type: **SMD2835**
 Γωνία Δέσμης Φωτός / Beam Angle: **90°**
 Ενεργειακή Κλάση / Energy Class: **F**
 Start Time: **1sec** • PF > **0.90** • CRI > **80** • IK05
 Υλικό / Material: **Πλαστικό & ABS/ Plastic & ABS**
 Σύνδεση / Connection: **Καλώδιο / Wire**



NON DIMMABLE **Lm/W 100** **-30 | +50 °C** **COLOR WHITE** **30.000h** **ON OFF 15.000** **IP68** **2 YEARS WARRANTY**

CODE	BARCODE	WATT	AMPERAGE	KELVIN	DIMENSIONS	WEIGHT	PACKING	MOQ	PRICE (€)
145-55900	5206139047595	18	1875mA	6500	Ø230x58mm	0.69kg	1/10	1	91,55
145-55904	5207227059872	18	1875mA	3000	Ø230x58mm	0.69kg	1/10	1	91,55
145-55901	5206139047618	18	1875mA	BLUE	Ø230x58mm	0.69kg	1/10	1	91,55
145-55902	5206139047632	18	1875mA	RGB	Ø230x58mm	0.69kg	1/10	1	112,60

ΣΠΟΤ ΣΥΝΤΡΙΒΑΝΙΟΥ LED UNDERWATER LED SPOT

Volt: **12V AC 50/60Hz**
 Γωνία Δέσμης Φωτός / Beam Angle: **90°**
 Ενεργειακή Κλάση / Energy Class: **G**
 PF > **0.80** • IK07
 Υλικό / Material: **Ανοξείδωτο Ατσάλι & Γυαλί / Stainless Steel & Glass**
 Σύνδεση / Connection: **Κλέμμα / Terminal Block**



Συμπεριλαμβάνεται Λάμπα / Lighting Source Included

GU5.3 BASE **GROUNDING** **NON DIMMABLE** **Lm/W 80** **-30 | +50 °C** **IP68** **2 YEARS WARRANTY**

CODE	BARCODE	WATT	KELVIN	DIMENSIONS	WEIGHT	PACKING	MOQ	PRICE (€)
145-55920	5207227267024	7	6500	Ø100x86mm	0.63kg	1/20	1	36,65

ΒΑΣΗ ΓΙΑ ΦΩΤΙΣΤΙΚΟ ΠΙΣΙΝΑΣ FIXTURE FOR VINYL POOL

Υλικό / Material:
Πλαστικό & ABS/ Plastic & ABS



-30 | +50 °C **IP68** **2 YEARS WARRANTY**

CODE	BARCODE	DIMENSIONS	COLOR	WEIGHT	PACKING	MOQ	PRICE (€)
145-55906	5207227147449	165x290mm	WHITE	1.524kg	1/4	1	103,45

ΥΠΟΒΡΥΧΙΟ LED KIT SPOT ΦΩΤΙΣΤΙΚΟ RGB (ΣΕΤ 3 ΤΕΜ.) UNDERWATER LED KIT SPOT LIGHT RGB (SET 3 PCS)

Με Τηλεχειριστήριο Υπερύθρων (περιλαμβάνει μπαταρίες) /
With Infrared Remote Control (batteries included)

Volt: **4,5V** • LED Type: **SMD5050**

Γωνία Δέσμης Φωτός / Beam Angle: **60°**

Start Time: **0,5sec** • **IK08**

Υλικό / Material: **Χαλκός & Πλαστικό / Copper & Plastic**



CODE	BARCODE	WATT	AMPERAGE	KELVIN	DIMENSIONS	WEIGHT	PACKING	MOQ	PRICE (€)
145-55910	5207227147180	2	450mA	RGB	264x116x35mm	0.28kg	1/40	1	15,65
145-55911	5207227147197	2	450mA	RGB	235x212x35mm	0.45kg	1/40	1	24,55



ΜΠΑΛΑ ΕΠΑΝΑΦΟΡΤΙΖΟΜΕΝΗ RGBWW GLOBE RECHARGEABLE RGBWW



Με Τηλεχειριστήριο Υπερύθρων (περιλαμβάνει μπαταρίες) /
With Infrared Remote Control (baterries included)

Volt: **100-240V 50/60Hz**

Start Time: **0,5sec • IK08**

Υλικό / Material: **Πολυεθυλαίνιο/ Polyethylene**

Τύπος Μπαταρίας / Battery Type: **Lithium 5V 2000mAh**

Charging Time: **8h**

Discharging Time: **16h**



CODE	BARCODE	WATT	AMPERAGE	KELVIN	DIMENSIONS	WEIGHT	PACKING	MOQ	PRICE (€)
153-55350	5207227062469	5	1000mA	RGBWW	Ø300mm	1.1kg	1/2	1	94,85
153-55351	5207227062476	5	1000mA	RGBWW	Ø400mm	1.5kg	1/1	1	106,45
153-55352	5207227062483	5	1000mA	RGBWW	Ø500mm	2.3kg	1/1	1	145,60



ΜΠΑΛΑ ΠΛΑΣΤΙΚΗ ΜΕ ΓΡΙΦΑ

PLASTIC GLOBE WITH BASE



Υλικό / Material: **PMMA & ABS**

E27
BASE

-20 | +50 °C

IP65

2 YEARS WARRANTY

CODE	BARCODE	DIMENSIONS	WEIGHT	COLOR	PACKING	MOQ	PRICE (€)
153-55300	5207227011788	Ø200x200mm	0.279kg	OPAL	1/18	1	8,95
153-55301	5207227011818	Ø250x250mm	0.420kg	OPAL	1/12	1	13,55
153-55302	5207227011115	Ø300x300mm	0.603kg	OPAL	1/8	1	17,85
153-55303	5207227011153	Ø400x400mm	1.131kg	OPAL	1/4	1	39,65
153-55305	5207227011054	Ø200x200mm	0.279kg	HONEY	1/18	1	8,95
153-55306	5207227011092	Ø250x250mm	0.420kg	HONEY	1/12	1	13,55
153-55307	5207227011139	Ø300x300mm	0.603kg	HONEY	1/8	1	17,85
153-55308	5207227011177	Ø400x400mm	1.131kg	HONEY	1/4	1	39,65

ΑΞΕΣΟΥΑΡ ΓΙΑ ΜΠΑΛΑ ΠΛΑΣΤΙΚΗ

ACCESSORIES FOR PLASTIC GLOBE

153-55310
153-55311

153-55312

153-55313

Υλικό / Material: **PVC & ABS**

-20 | +50 °C

COLOR
BLACK

2 YEARS WARRANTY



CODE	BARCODE	DESCRIPTION	DIMENSIONS	WEIGHT	PACKING	MOQ	PRICE (€)
153-55310	5207227011832	ΚΟΛΩΝΑΚΙ ΔΑΠΕΔΟΥ / FLOOR LIGHT COLUMN	Ø60x1000mm	1.1kg	1/12	1	14,35
153-55311	5207227011030	ΚΟΛΩΝΑΚΙ ΔΑΠΕΔΟΥ / FLOOR LIGHT COLUMN	Ø60x1800mm	1.98kg	1/6	1	25,65
153-55312	5207227011078	ΒΑΣΗ ΓΙΑ ΚΟΛΩΝΑ / BASE FOR COLUMN	Ø160x170mm	0.186kg	1/50	1	5,85
153-55313	5207227011023	ΚΟΛΩΝΑΚΙ ΔΑΠΕΔΟΥ / FLOOR LIGHT COLUMN	Ø160x120mm	0.065kg	1/50	1	3,45

INDEX

CODE	PAGE	CODE	PAGE	CODE	PAGE	CODE	PAGE	CODE	PAGE
145-56200	10	145-56140	18	145-56290	26	145-68607	38	145-68206	44
145-56201	10	145-56141	18	145-56291	26	145-68608	38	145-68080	45
145-56202	10	145-56142	18	145-56193	26	145-68609	38	145-68081	45
145-56203	10	145-56143	18	145-56194	26	145-68610	38	145-68090	45
145-56204	10	145-56144	18	145-56290	26	145-68611	38	145-68091	45
145-56205	10	145-56145	18	145-56291	26	145-68612	38	145-68096	46
145-56209	11	145-56146	19	145-56195	27	145-68613	38	145-68098	46
145-56210	11	145-56147	19	145-56139	27	145-68614	38	145-68097	46
145-56211	11	145-56148	19	145-56186	27	145-68000	39	145-68093	47
145-56212	11	145-56150	20	145-56180	28	145-68001	39	145-68092	47
145-56213	11	145-56151	20	145-65011	30	145-68010	39	145-68490	47
145-56214	11	145-56152	20	145-65012	30	145-68011	39	145-68491	47
145-56320	12	145-56153	20	145-65014	30	145-68012	39	145-68492	47
145-56321	12	145-56154	20	145-65015	30	145-68015	39	145-68099	47
145-56322	12	145-56155	20	145-65017	30	145-68014	39	147-68973	48
145-56323	12	145-56223	20	145-65018	30	145-68013	39	145-68500	50
145-56324	12	145-56224	20	145-65020	31	145-68020	39	145-68501	50
145-56325	12	145-56225	20	145-65021	31	145-68021	39	145-68502	50
145-56330	13	145-56156	21	145-65022	31	145-68022	39	145-68506	50
145-56331	13	145-56157	21	145-65023	31	145-68023	39	145-68507	50
145-56332	13	145-56158	21	145-65200	32	145-68024	39	145-68508	50
145-56333	13	145-56226	21	145-65201	32	145-68025	39	145-68510	50
145-56334	13	145-56227	21	145-65202	32	145-68450	41	145-68511	50
145-56335	13	145-56228	21	145-65210	33	145-68451	41	145-68512	50
145-56350	14	145-56160	22	145-65211	33	145-68452	41	145-68546	50
145-56351	14	145-56161	22	145-68902	33	145-68410	41	145-68547	50
145-56310	15	145-56162	22	145-68900	34	145-68411	41	145-68548	50
145-56311	15	145-56163	22	145-65100	35	145-68412	41	145-68513	51
145-56312	15	145-56164	22	145-68910	35	145-68400	41	145-68514	51
145-56313	15	145-56165	22	145-68911	35	145-68401	41	145-68515	51
145-56314	15	145-56170	23	145-68912	35	145-68402	41	145-68516	51
145-56315	15	145-56171	23	145-68100	36	145-68423	42	145-68517	51
145-56230	16	145-56172	23	145-68101	36	145-68424	42	145-68518	51
145-56231	16	145-56173	23	145-68102	36	145-68425	42	145-68549	51
145-56232	16	145-56174	23	145-68103	36	145-68420	42	145-68550	51
145-56233	16	145-56175	23	145-68104	36	145-68421	42	145-68551	51
145-56234	16	145-56300	24	145-68600	37	145-68422	42	145-68671	51
145-56235	16	145-56301	24	145-68601	37	145-68430	43	145-68672	51
145-56240	17	145-56302	24	145-68602	37	145-68431	43	145-68520	52
145-56241	17	145-56303	24	145-68620	37	145-68432	43	145-68521	52
145-56242	17	145-56304	24	145-68621	37	145-68433	43	145-68522	52
145-56243	17	145-56305	24	145-68622	37	145-68434	43	145-68526	52
145-56244	17	145-56196	25	145-68604	37	145-68435	43	145-68527	52
145-56245	17	145-56390	25	145-68630	37	145-68436	43	145-68528	52
145-56250	17	145-56197	25	145-68631	37	145-68437	43	145-68530	52
145-56251	17	145-56391	25	145-68632	37	145-68438	43	145-68531	52
145-56252	17	145-68095	25	145-68633	37	145-68252	44	145-68532	52
145-56253	17	145-56190	25	145-68634	37	145-68201	44	145-68558	52
145-56254	17	145-56191	25	145-68635	37	145-68202	44	145-68559	52
145-56255	17	145-56192	25	145-68606	38	145-68205	44	145-68560	52

CODE	PAGE	CODE	PAGE	CODE	PAGE	CODE	PAGE	CODE	PAGE
145-68533	53	147-52649	69	147-52631	76	145-50114	92	145-50420	94
145-68534	53	147-52650	69	147-52632	76	145-50115	92	145-50421	94
145-68535	53	147-52651	69	147-52640	76	145-50120	92	145-50422	94
145-68536	53	147-52652	69	147-52641	76	145-50121	92	145-50423	94
145-68537	53	147-52653	69	147-52642	76	145-50122	92	145-50424	94
145-68538	53	147-52654	69	147-53200	78	145-50123	92	145-50425	94
145-68561	53	147-52655	70	147-53202	78	145-50124	92	145-50430	94
145-68562	53	147-52656	70	147-53203	78	145-50125	92	145-50431	94
145-68563	53	147-52657	70	147-53201	79	145-50130	92	145-50432	94
145-68654	53	147-52658	70	147-53205	79	145-50131	92	145-50433	94
145-68655	53	147-52659	70	147-53206	79	145-50132	92	145-50434	94
145-65800	54	147-52660	70	147-53204	80	145-50133	92	145-50435	94
145-65801	54	147-52530	72	147-53207	80	145-50134	92	145-50440	94
145-65802	54	147-52531	72	147-53208	80	145-50135	92	145-50441	94
145-65803	54	147-52532	72	147-53300	81	145-50200	93	145-50442	94
145-65806	54	147-52533	72	147-53301	81	145-50201	93	145-50443	94
145-65807	54	147-52534	72	147-53305	81	145-50202	93	145-50444	94
145-68571	56	147-52535	72	147-53302	82	145-50203	93	145-50445	94
145-68572	56	147-52540	73	147-53303	82	145-50204	93	145-50500	95
145-68573	56	147-52541	73	147-53304	82	145-50205	93	145-50501	95
145-68575	56	147-52120	73	147-53306	83	145-50210	93	145-50502	95
145-68576	56	147-52121	73	147-53307	83	145-50211	93	145-50503	95
145-68577	56	147-52100	74	147-53308	83	145-50212	93	145-50504	95
145-68578	56	147-52101	74	147-53310	85	145-50213	93	145-50505	95
145-68579	56	147-52110	74	147-53311	85	145-50214	93	145-50510	95
145-28200	58	147-52111	74	147-53313	85	145-50215	93	145-50511	95
145-28201	58	147-52510	75	147-53312	86	145-50220	93	145-50512	95
145-28202	58	147-52511	75	147-53309	86	145-50221	93	145-50513	95
145-28204	59	147-52513	75	147-53314	86	145-50222	93	145-50514	95
145-28000	60	147-55610	75	145-59801	88	145-50223	93	145-50515	95
145-28001	60	147-55617	75	145-59802	88	145-50224	93	145-50520	95
145-28010	60	147-55611	75	145-55092	88	145-50225	93	145-50521	95
145-28100	61	147-55612	75	145-56800	91	145-50230	93	145-50522	95
145-28110	61	147-55613	75	145-56801	91	145-50231	93	145-50523	95
145-28102	61	147-55614	75	145-56802	91	145-50232	93	145-50524	95
145-28500	63	147-55615	75	145-56803	91	145-50233	93	145-50525	95
145-28203	63	147-55616	75	145-56804	91	145-50234	93	145-50530	95
145-28400	63	147-55603	75	145-56805	91	145-50235	93	145-50531	95
145-55301	64	147-52520	75	145-56806	91	145-50400	94	145-50532	95
145-55302	64	147-52521	75	145-56807	91	145-50401	94	145-50533	95
145-55307	65	147-52523	75	145-50100	92	145-50402	94	145-50534	95
145-28205	66	147-55620	75	145-50101	92	145-50403	94	145-50535	95
145-28510	66	147-55621	75	145-50102	92	145-50404	94	145-50540	95
145-28600	66	147-55622	75	145-50103	92	145-50405	94	145-50541	95
147-52643	68	147-55623	75	145-50104	92	145-50410	94	145-50542	95
147-52644	68	147-55624	75	145-50105	92	145-50411	94	145-50543	95
147-52645	68	147-55625	75	145-50110	92	145-50412	94	145-50544	95
147-52646	68	147-55626	75	145-50111	92	145-50413	94	145-50545	95
147-52647	68	147-55627	75	145-50112	92	145-50414	94	145-50700	96
147-52648	68	147-52630	76	145-50113	92	145-50415	94	145-50701	96

Index

CODE	PAGE	CODE	PAGE	CODE	PAGE	CODE	PAGE	CODE	PAGE
145-50702	96	145-50840	97	145-59561	110	145-59906	118	145-59027	127
145-50703	96	145-50841	97	145-59562	110	145-59915	118	145-59008	128
145-50704	96	145-50842	97	145-59550	110	145-59910	119	145-59028	128
145-50705	96	145-50843	97	145-59551	110	145-59912	119	145-59010	128
145-50710	96	145-50844	97	145-59552	110	145-59914	119	145-59030	128
145-50711	96	145-50845	97	145-59563	110	145-59911	119	145-59009	128
145-50712	96	145-79800	98	145-59553	110	145-59913	119	145-59029	128
145-50713	96	145-79801	98	145-59564	110	145-59916	119	145-59300	130
145-50714	96	145-79802	98	145-59554	110	145-59917	120	145-59301	130
145-50715	96	145-79803	98	145-59565	111	145-59919	120	145-59302	130
145-50720	96	145-79804	98	145-59555	111	145-59921	120	145-59303	130
145-50721	96	145-79805	98	145-59567	111	145-59918	120	145-59304	130
145-50722	96	145-79806	98	145-59557	111	145-59920	120	145-59305	130
145-50723	96	145-79807	98	145-59559	111	145-59040	122	145-59306	130
145-50724	96	145-79808	98	145-59566	111	145-59041	122	145-59307	130
145-50725	96	145-79809	98	145-59556	111	145-59058	122	145-59315	131
145-50730	96	145-79810	98	145-59568	111	145-59059	122	145-59316	131
145-50731	96	145-79811	98	145-59558	111	145-59050	123	145-59310	131
145-50732	96	145-79812	98	145-59560	111	145-59051	123	145-59311	131
145-50733	96	145-59500	100	145-59540	112	145-59052	123	145-59400	132
145-50734	96	145-59501	100	145-59541	112	145-59053	123	145-59401	132
145-50735	96	145-59502	100	145-59542	112	145-59054	123	145-59402	132
145-50740	96	145-59503	100	145-59543	112	145-59055	123	145-59403	132
145-50741	96	145-59504	101	145-59544	112	145-59056	123	145-59404	132
145-50742	96	145-59505	101	145-59545	112	145-59057	123	145-59405	132
145-50743	96	145-59506	101	145-59930	114	145-59046	123	145-59406	132
145-50744	96	145-59507	101	145-59931	114	145-59047	123	145-59407	132
145-50745	96	145-59508	102	145-59934	114	145-59075	124	145-59408	133
145-50800	97	145-59509	102	145-59935	114	145-59085	124	145-59409	133
145-50801	97	145-59510	102	145-59932	114	145-59070	124	145-59410	133
145-50802	97	145-59511	102	145-59933	114	145-59080	124	145-59411	133
145-50803	97	145-59512	103	145-59936	114	145-59073	124	145-59312	134
145-50804	97	145-59513	103	145-59937	114	145-59083	124	145-59313	134
145-50805	97	145-59514	104	145-59938	115	145-59071	125	145-59314	134
145-50810	97	145-59515	104	145-59939	115	145-59081	125	145-59380	134
145-50811	97	145-59516	104	145-59942	115	145-59072	125	145-59381	134
145-50812	97	145-59517	104	145-59940	115	145-59082	125	145-59350	135
145-50813	97	145-59518	105	145-59941	115	145-59000	126	145-59351	135
145-50814	97	145-59519	105	145-59950	116	145-59001	126	145-59330	135
145-50815	97	145-59520	105	145-59954	116	145-59020	126	145-59331	135
145-50820	97	145-59522	106	145-59952	116	145-59021	126	145-59602	136
145-50821	97	145-59529	106	145-59953	116	145-59002	127	145-59603	136
145-50822	97	145-59523	106	145-59955	116	145-59022	127	145-59604	136
145-50823	97	145-59530	106	145-59956	116	145-59004	127	145-59605	136
145-50824	97	145-59524	107	145-59900	117	145-59024	127	145-55090	137
145-50825	97	145-59525	107	145-59901	117	145-59006	127	145-55091	137
145-50830	97	145-59531	107	145-59902	117	145-59026	127	145-59240	138
145-50831	97	145-59526	108	145-59903	117	145-59003	127	145-59241	138
145-50832	97	145-59532	108	145-59907	118	145-59023	127	145-59250	138
145-50833	97	145-59527	108	145-59904	118	145-59005	127	145-59251	138
145-50834	97	145-59528	109	145-59905	118	145-59025	127	145-59242	138
145-50835	97	145-59533	109	145-59908	118	145-59007	127	145-59252	138

CODE	PAGE
145-59243	138
145-59253	138
145-59245	139
145-59255	139
145-59247	139
145-59257	139
145-59249	139
145-59246	139
145-59256	139
145-59248	139
145-59258	139
145-59200	140
145-59201	140
145-59215	140
145-59220	140
145-59221	140
145-59235	140
145-59202	141
145-59222	141
145-59204	141
145-59224	141
145-59206	141
145-59226	141
145-59203	141
145-59223	141
145-59205	141
145-59225	141
145-59207	141
145-59227	141
145-59208	142
145-59228	142
145-59209	142
145-59229	142
145-59214	142
145-59234	142
145-59210	142
145-59230	142
145-59212	142
145-59232	142
145-59211	142
145-59231	142
145-55320	144
145-55322	144
145-55324	144
145-55323	145
147-55300	146
147-55301	146
147-55303	146
147-55304	146
147-55306	146
147-55307	146
147-55309	146

CODE	PAGE
147-55310	146
147-55312	146
147-55313	146
147-55320	146
147-55321	146
147-55322	146
147-55323	146
147-55324	146
147-56550	147
147-56551	147
147-56556	147
147-56553	147
147-56554	147
147-56557	147
147-56560	147
147-56561	147
147-56562	147
147-56563	147
147-56564	147
147-56565	147
147-56020	147
147-56021	147
147-56022	147
147-56023	147
147-56050	148
147-56051	148
147-56052	148
147-56610	150
147-56611	150
147-56613	150
147-56614	150
147-56616	150
147-56617	150
147-56620	150
147-56621	150
147-56622	150
147-56623	150
147-56624	150
147-56625	150
147-56626	150
147-56627	150
147-56628	150
147-56600	151
147-56601	151
147-56603	151
147-56604	151
147-56606	151
147-56607	151
147-56633	151
147-56634	151
147-56636	151
147-56637	151

CODE	PAGE
147-56060	152
147-56061	152
147-56062	152
147-56063	152
147-56064	152
147-56065	152
147-56070	153
147-56071	153
147-56072	153
147-56073	153
147-56078	153
147-56079	153
147-56660	154
147-56661	154
147-56662	154
147-56675	154
147-56676	154
147-56670	155
147-56671	155
147-56640	156
147-56642	156
147-56644	156
147-56653	156
147-56654	156
147-56656	156
147-56657	156
147-56680	157
147-56681	157
147-56682	157
147-56683	157
147-56684	157
147-56685	157
147-56686	157
147-56687	157
145-58000	158
145-58001	158
145-58002	158
145-58003	158
145-58004	158
145-58005	158
145-58006	158
145-58007	158
145-58150	158
145-58100	159
145-58101	159
145-58102	159
145-58103	159
145-58104	159
145-58105	159
145-58106	159
145-58107	159
145-58108	159

CODE	PAGE
145-58109	159
145-58110	159
145-58111	159
145-58151	159
145-58170	160
145-58171	160
145-58172	160
145-58173	160
145-58224	160
145-58225	160
145-58200	161
145-58202	161
145-58204	161
145-58201	161
145-58203	161
145-58205	161
145-58206	162
145-58208	162
145-58207	162
145-58209	162
145-58210	163
145-58212	163
145-58211	163
145-58213	163
145-58214	164
145-58216	164
145-58215	164
145-58217	164
145-58218	165
145-58220	165
145-58219	165
145-58221	165
145-58222	166
145-58223	166
147-69310	168
147-69311	168
147-69312	168
147-69313	168
147-69314	168
147-69315	168
147-69316	168
147-69317	168
147-69318	168
147-69319	168
147-69320	168
147-69321	168
147-69322	169
147-69323	169
147-69324	169
147-69325	169
147-69326	169
147-69327	169

CODE	PAGE
147-69328	169
147-69329	169
147-69330	169
147-69331	169
147-69332	169
147-69333	169
147-69337	170
147-69338	170
147-69339	170
147-69350	170
147-69351	170
147-69352	170
147-69353	171
147-69354	171
147-69355	171
147-69356	172
147-69357	172
147-69358	172
147-69359	172
147-69701	173
147-69702	173
147-69704	173
147-69705	173
147-69707	173
147-69708	173
147-69710	173
147-69711	173
147-69650	174
147-69651	174
147-69630	174
147-69631	174
147-69653	174
147-69654	174
147-69633	174
147-69634	174
147-69656	175
147-69636	175
147-69637	175
147-69638	175
147-69659	175
147-69660	175
147-69642	175
147-69643	175
147-69360	176
147-69361	176
147-69362	176
147-69363	176
147-69364	176
147-69365	176
147-69380	176
147-69381	176
147-69382	176

Index

CODE	PAGE	CODE	PAGE	CODE	PAGE	CODE	PAGE	CODE	PAGE
147-69383	176	146-69163	191	146-57104	200	146-57043	203	145-67143	213
147-69384	176	146-69164	191	146-57105	200	146-57044	203	145-67144	213
147-69385	176	146-69165	192	146-57106	200	146-57045	203	145-67145	213
147-69386	177	146-69166	192	146-57107	200	146-57046	203	145-67146	213
147-69387	177	146-69167	192	146-57108	200	146-57047	203	145-67100	214
147-69300	177	146-69168	192	146-57109	200	146-58000	204	145-67101	214
147-69302	177	146-69171	192	146-57110	200	146-58001	204	145-67103	214
147-69304	177	146-69172	192	146-57111	200	146-58002	204	145-67104	214
147-69390	178	146-69173	193	146-57112	200	146-58003	204	145-67106	214
147-69270	178	146-69174	193	146-57113	200	146-58004	204	145-67107	214
147-69271	178	146-69175	193	146-57114	200	146-58005	204	145-67109	214
147-69273	178	146-69176	193	146-57115	200	146-58006	204	145-67110	214
147-69240	179	146-69000	195	146-57116	200	146-58007	204	145-55900	216
147-69241	179	146-69001	195	146-57117	200	146-58008	204	145-55904	216
147-69370	179	146-69002	195	146-57118	200	146-58009	204	145-55901	216
147-69372	179	146-69003	195	146-57119	200	146-58010	204	145-55902	216
147-22420	180	146-69004	195	146-57120	200	146-58011	204	145-55920	216
147-22421	180	146-69005	195	200-57803	201	145-57550	204	145-55906	216
147-22422	180	146-69006	196	200-57804	201	146-58021	205	145-55910	217
147-69570	181	146-69007	196	200-57808	201	146-58022	205	145-55911	217
147-69571	181	146-69008	196	200-57809	201	146-58012	205	153-55350	218
147-69572	182	146-69009	196	200-57810	201	146-58013	205	153-55351	218
147-69573	182	146-69010	196	200-57811	201	146-58014	205	153-55352	218
147-69574	183	146-69011	196	200-57812	201	146-58015	205	153-55300	219
147-69575	183	146-57050	198	200-57813	201	146-58016	205	153-55301	219
147-69594	184	146-57051	198	200-57814	201	146-58017	205	153-55302	219
147-69593	184	146-57052	198	200-57815	201	146-58018	205	153-55303	219
147-69580	185	146-57053	198	146-57000	202	146-58019	205	153-55305	219
147-69581	185	146-57054	198	146-57001	202	146-58020	205	153-55306	219
147-69582	185	146-57055	198	146-57002	202	146-57900	206	153-55307	219
147-69583	186	146-57056	198	146-57003	202	146-57901	206	153-55308	219
147-69584	186	146-57057	198	146-57004	202	146-57902	206	153-55310	219
147-69585	186	146-57058	198	146-57005	202	146-57903	207	153-55311	219
147-69586	186	146-57059	198	146-57006	202	147-22410	207	153-55312	219
146-69100	188	146-57060	198	146-57007	202	147-22419	207	153-55313	219
146-69101	188	146-57061	198	146-57008	202	147-22411	207	153-55312	219
146-69103	188	146-57062	199	146-57009	202	147-22415	207	153-55313	219
146-69104	188	146-57063	199	146-57010	202	147-22416	207	153-55310	219
146-69110	188	146-57064	199	146-57011	202	147-22430	207	153-55311	219
146-69111	188	146-57065	199	146-57030	203	147-22432	207		
146-69112	188	146-57066	199	146-57031	203	147-22434	207		
146-69113	188	146-57067	199	146-57032	203	147-56321	208		
146-69114	188	146-57068	199	146-57033	203	147-56322	208		
146-69115	189	146-57069	199	146-57034	203	145-67123	210		
146-69116	189	146-57070	199	146-57035	203	145-67124	210		
146-69117	189	146-57071	199	146-57036	203	145-67126	210		
146-69152	190	146-57072	199	146-57037	203	145-67130	211		
146-69153	190	146-57073	199	146-57038	203	145-67131	211		
146-69157	190	146-57100	200	146-57039	203	145-67132	211		
146-69158	190	146-57101	200	146-57040	203	145-67135	211		
146-69159	191	146-57102	200	146-57041	203	145-67136	211		
146-69160	191	146-57103	200	146-57042	203	145-67138	212		



SHOP & FOLLOW

EUROLAMP®

EUROLAMP S.A.
3rd km Symmachiki road, Oraioakastro, 57013
Thessaloniki, Greece

T. +30 2310 574802, F. +30 2310 574919,
E. info@eurolamp.gr

www.eurolamp.gr

PROFESSIONAL *Lighting* COLLECTION